

Mar. 2009



# SERVICE MANUAL ADDENDUM

---

## UR-FR6000 UR-FR6100

---

### CONTENTS

PARTS LIST .....	1
VOLTAGE DIAGRAM .....	9

# PARTS LIST

## [MAIN UNIT]

REF NO.	ORDER NO.	DESCRIPTION	M.	H/V LOCATION
IC1	1110005330	S.IC NJM12904V-TE1-#ZZZB	T	58.1/71.4
IC2	1110007290	S.IC AK2330P-L	T	58.7/56.1
IC3	1130010100	S.IC LMX2352TMX/NOPB	B	120.2/43.9
IC4	1130010100	S.IC LMX2352TMX/NOPB	B	28/78.8
IC5	1110003491	S.IC TA31136FNG(D,EL)	B	70.4/82.5
IC7	1110007280	S.IC NJM2716F-TE1-#ZZZB	B	56.8/46.4
IC8	1130012910	S.IC AK4554VTP-E2/P	B	36.2/59.9
IC9	1190002080	S.IC AD7476ARTZ-500RL7	B	49.6/46.4
IC10	1130013040	S.IC TC7WBD125AFK(T5L,F)	B	46.6/49.2
IC11	1110006230	S.IC NJM2711F-TE1-#ZZZB	B	53.1/35
IC12	1140013290	S.IC TMS320VC5509AZHH	B	33.3/37.8
IC13	1180002590	S.REG XC6204B332MR	T	80.9/21.3
IC14	1180003270	S.REG R1114Q161D-TR-F	T	84.4/21.4
IC15	1180002590	S.REG XC6204B332MR	T	87.8/21.3
IC17	1190001340	S.IC M62334FP 600C	T	67.3/61.7
IC18	1110005771	S.IC S-80942CNMC-G9CT2G	T	41.2/52.8
IC20	1140014550	S.IC HD64F2506RFC26DV(EMPTY)	T	33.5/37.6
IC21	1140012950	S.IC 24LC512T-I/SM	T	59.1/21.8
IC22	1150002211	IC RA55H4047M-121 [USA-01]		
	1150002211	IC RA55H4047M-121 [EXP-01]		
	1150002221	IC RA55H4452M-121 [USA-02]		
	1150002221	IC RA55H4452M-121 [EXP-02]		
	1150002092	IC RA30H4047M-121 [EUR-01]		
IC23	1110002751	S.IC TA75S01F(TE85R,F)	T	139.3/125.6
IC25	1130008561	S.IC TC75S51F(TE85L,F)	B	29/16.3
IC26	1120003070	S.IC MAX3232EIPWR	T	42.7/70
IC27	1180001251	S.IC TA7808F(TE16L,Q)	T	116.6/84.1
IC28	1110003091	IC LA4425A-E		
IC29	1110002751	S.IC TA75S01F(TE85R,F)	T	12/123.1
IC30	1110003390	S.IC AN8005M(-E1)	T	114.1/91.8
IC31	1130011760	S.IC CD4094BPWR	T	8.1/45.2
IC32	1130013360	S.IC AT25F2048N-10SU-2.7SL383	B	8.9/36.1
IC34	1110005340	S.IC NJM12902V-TE1-#ZZZB	B	12.2/58.2
IC35	1140013200	S.IC CD4053BPWR	B	20.6/58.2
IC36	1110005330	S.IC NJM12904V-TE1-#ZZZB	B	27.8/55.4
IC37	1120002830	S.IC NJM2125F-TE1-#FZZB	T	56.6/66.7
IC38	1110006380	S.IC LM2904PWR	T	114.1/23.8
IC39	1180001071	S.IC TA7805F(TE16L,Q)	T	101.2/24.3
IC40	1110005330	S.IC NJM12904V-TE1-#ZZZB	B	50.6/57.2
IC41	1180001251	S.IC TA7808F(TE16L,Q)	B	132/16.7
Q1	1590003230	S.TRA UNR9113J-(TX) [USA-01]	B	53.4/79.7
	1590003230	S.TRA UNR9113J-(TX) [EXP-01]		
	1590003230	S.TRA UNR9113J-(TX) [USA-02]		
	1590003230	S.TRA UNR9113J-(TX) [EXP-02]		
	1590003230	S.TRA UNR9113J-(TX) [EUR-01]		
Q2	1530002851	S.TRA 25C4116-BL(TE85R,F)	B	34.9/77.7
Q3	1560001360	S.FET 2SK3019 TL	B	66.4/76.6
Q4	1560000541	S.FET 2SK880-Y(T5RICOM,F)	B	88.8/41.5
Q5	1560000541	S.FET 2SK880-Y(T5RICOM,F)	B	33.3/107.5
Q6	1560000541	S.FET 2SK880-Y(T5RICOM,F)	B	29.6/101.3
Q7	1530002601	S.FET 2SC4215-O(TE85R,F)	B	72.9/92.5
Q8	1560000541	S.FET 2SK880-Y(T5RICOM,F)	B	92.7/47.7
Q9	1560001360	S.FET 2SK3019 TL	B	39.5/104.5
Q10	1530002851	S.TRA 25C4116-BL(TE85R,F)	B	88.8/44.6
Q11	1530002851	S.TRA 25C4116-BL(TE85R,F)	B	29.6/104.4
Q12	1590003230	S.TRA UNR9113J-(TX) [USA-01]	B	65.6/101.6
	1590003230	S.TRA UNR9113J-(TX) [EXP-01]		
	1590003230	S.TRA UNR9113J-(TX) [USA-02]		
	1590003230	S.TRA UNR9113J-(TX) [EXP-02]		
	1590003230	S.TRA UNR9113J-(TX) [EUR-01]		
Q13	1530002851	S.TRA 25C4116-BL(TE85R,F)	B	88.8/47.7
Q14	1530002851	S.TRA 25C4116-BL(TE85R,F)	B	29.6/107.5
Q15	1530002851	S.TRA 25C4116-BL(TE85R,F)	B	92.7/44.6
Q16	1530002851	S.TRA 25C4116-BL(TE85R,F)	B	33.3/104.5
Q19	1530002601	S.TRA 2SC4215-O(TE85R,F)	B	63.2/106.8
Q20	1530002920	S.TRA 2SC4226-T1 R25	B	38.8/123.1
Q21	1530002920	S.TRA 2SC4226-T1 R25	B	39.6/114.5
Q22	1530002920	S.TRA 2SC4226-T1 R25	B	94.6/64.3
Q23	1530002920	S.TRA 2SC4226-T1 R25	B	95.2/55.4
Q24	1530003311	S.TRA 2SC5107-O(TE85R,F)	B	100.5/58.6
Q25	1530003311	S.TRA 2SC5107-O(TE85R,F)	B	44.9/116.2
Q26	1590001400	S.TRA XP1214(TX)	B	40.5/117.8
Q27	1590001400	S.TRA XP1214(TX)	B	96/59.6
Q28	1590003290	S.TRA UNR9213J-(TX) [USA-01]	B	93.3/59.6
	1590003290	S.TRA UNR9213J-(TX) [EXP-01]		
	1590003290	S.TRA UNR9213J-(TX) [USA-02]		
	1590003290	S.TRA UNR9213J-(TX) [EXP-02]		
	1590003290	S.TRA UNR9213J-(TX) [EUR-01]		
Q29	1590003290	S.TRA UNR9213J-(TX) [USA-01]	T	57.2/41.9
	1590003290	S.TRA UNR9213J-(TX) [EXP-01]		
	1590003290	S.TRA UNR9213J-(TX) [USA-02]		
	1590003290	S.TRA UNR9213J-(TX) [EXP-02]		
Q30	1590003290	S.TRA UNR9213J-(TX) [EUR-01]	B	37.8/117.8
	1590003290	S.TRA UNR9213J-(TX) [USA-01]		
	1590003290	S.TRA UNR9213J-(TX) [EXP-01]		
	1590003290	S.TRA UNR9213J-(TX) [USA-02]		
	1590003290	S.TRA UNR9213J-(TX) [EXP-02]		
Q31	1590003290	S.TRA UNR9213J-(TX) [EUR-01]	T	57.2/39.8
	1590003230	S.TRA UNR9113J-(TX) [USA-01]		
	1590003230	S.TRA UNR9113J-(TX) [EXP-01]		
	1590003230	S.TRA UNR9113J-(TX) [USA-02]		
	1590003230	S.TRA UNR9113J-(TX) [EXP-02]		
Q32	1530003380	S.TRA 2SC5700WB-TR-E	B	46.5/109.1
Q33	1530003980	S.TRA 2SC5700WB-TR-E	B	102.1/53.4
Q34	1530003311	S.TRA 2SC5107-O(TE85R,F)	B	46.2/123.1

## [MAIN UNIT]

REF NO.	ORDER NO.	DESCRIPTION	M.	H/V LOCATION
Q35	1530003311	S.TRA 2SC5107-O(TE85R,F)	B	101.9/64.4
Q36	1580000731	S.FET 3SK293(TE85L,F)	B	47.3/136.1
Q37	1530003311	S.TRA 2SC5107-O(TE85R,F)	B	132.5/84.5
Q38	1530002680	S.TRA 2SC3357-T1	B	138.1/88.8
Q39	1560000841	S.FET 2SK1829(TE85R,F)	B	53.2/140.8
Q40	1590001190	S.TRA XP6501-(TX),AB	T	101.6/87.4
Q41	1520000460	S.TRA 2SB1132 J100 R	T	101.6/82.8
Q42	1590003290	S.TRA UNR9213J-(TX) [USA-01]	T	13.3/67.6
	1590003290	S.TRA UNR9213J-(TX) [EXP-01]		
	1590003290	S.TRA UNR9213J-(TX) [USA-02]		
	1590003290	S.TRA UNR9213J-(TX) [EXP-02]		
	1590003290	S.TRA UNR9213J-(TX) [EUR-01]		
Q43	1590003290	S.TRA UNR9213J-(TX) [USA-01]	T	138.8/122.9
	1590003290	S.TRA UNR9213J-(TX) [EXP-01]		
	1590003290	S.TRA UNR9213J-(TX) [USA-02]		
	1590003290	S.TRA UNR9213J-(TX) [EXP-02]		
	1590003290	S.TRA UNR9213J-(TX) [EUR-01]		
Q44	1590003290	S.TRA UNR9213J-(TX) [USA-01]	T	122.8/79.2
	1590003290	S.TRA UNR9213J-(TX) [EXP-01]		
	1590003290	S.TRA UNR9213J-(TX) [USA-02]		
	1590003290	S.TRA UNR9213J-(TX) [EXP-02]		
	1590003290	S.TRA UNR9213J-(TX) [EUR-01]		
Q45	1540000050	S.TRA 2SD1664 T100Q	T	117/76.3
Q46	1530002851	S.TRA 2SC4116-BL(TE85R,F)	T	137.4/120.3
Q48	1510000920	S.TRA 2SA1577 T106 Q	T	101.5/77.8
Q49	1590003290	S.TRA UNR9213J-(TX) [USA-01]	T	102.2/73.7
	1590003290	S.TRA UNR9213J-(TX) [EXP-01]		
	1590003290	S.TRA UNR9213J-(TX) [USA-02]		
	1590003290	S.TRA UNR9213J-(TX) [EXP-02]		
	1590003290	S.TRA UNR9213J-(TX) [EUR-01]		
Q52	1590003290	S.TRA UNR9213J-(TX) [USA-01]	T	10.9/131.6
	1590003290	S.TRA UNR9213J-(TX) [EXP-01]		
	1590003290	S.TRA UNR9213J-(TX) [USA-02]		
	1590003290	S.TRA UNR9213J-(TX) [EXP-02]		
	1590003290	S.TRA UNR9213J-(TX) [EUR-01]		
Q53	1590003290	S.TRA UNR9213J-(TX) [USA-01]	T	10.9/129.6
	1590003290	S.TRA UNR9213J-(TX) [EXP-01]		
	1590003290	S.TRA UNR9213J-(TX) [USA-02]		
	1590003290	S.TRA UNR9213J-(TX) [EXP-02]		
	1590003290	S.TRA UNR9213J-(TX) [EUR-01]		
Q56	1590003321	S.FET TPC6103(TE85L,F)	T	7.6/132.6
Q57	1550000190	S.FET 2SJ506STR-E	T	125.2/99.6
Q58	1590003290	S.TRA UNR9213J-(TX) [USA-01]	T	130.2/102.1
	1590003290	S.TRA UNR9213J-(TX) [EXP-01]		
	1590003290	S.TRA UNR9213J-(TX) [USA-02]		
	1590003290	S.TRA UNR9213J-(TX) [EXP-02]		
	1590003290	S.TRA UNR9213J-(TX) [EUR-01]		
Q59	1590000990	S.TRA DTC363EK T146	T	7.6/127.6
Q61	1530002851	S.TRA 2SC4116-BL(TE85R,F)	T	6.8/118.4
Q62	1540000441	S.TRA 2SD1619T-TD-E	T	118.4/18.5
Q63	1560000990	S.FET PMBFJ310	B	66.3/110
Q64	1560000990	S.FET PMBFJ310	B	63.3/110
Q65	1530003311	S.TRA 2SC5107-O(TE85R,F)	B	59.6/123.7
Q66	1590003290	S.TRA UNR9213J-(TX) [USA-01]	B	94.9/4.7
	1590003290	S.TRA UNR9213J-(TX) [EXP-01]		
	1590003290	S.TRA UNR9213J-(TX) [USA-02]		
	1590003290	S.TRA UNR9213J-(TX) [EXP-02]		
	1590003290	S.TRA UNR9213J-(TX) [EUR-01]		
Q67	1590003290	S.TRA UNR9213J-(TX) [USA-01]	B	124.9/4.7
	1590003290	S.TRA UNR9213J-(TX) [EXP-01]		
	1590003290	S.TRA UNR9213J-(TX) [USA-02]		
	1590003290	S.TRA UNR9213J-(TX) [EXP-02]		
	1590003290	S.TRA UNR9213J-(TX) [EUR-01]		
Q68	1590003290	S.TRA UNR9213J-(TX) [USA-01]	B	109.9/4.7
	1590003290	S.TRA UNR9213J-(TX) [EXP-01]		
	1590003290	S.TRA UNR9213J-(TX) [USA-02]		
	1590003290	S.TRA UNR9213J-(TX) [EXP-02]		
	1590003290	S.TRA UNR9213J-(TX) [EUR-01]		
Q69	1590003290	S.TRA UNR9213J-(TX) [USA-01]	T	9.5/53.3
	1590003290	S.TRA UNR9213J-(TX) [EXP-01]		
	1590003290	S.TRA UNR9213J-(TX) [USA-02]		
	1590003290	S.TRA UNR9213J-(TX) [EXP-02]		
	1590003290	S.TRA UNR9213J-(TX) [EUR-01]		
Q70	1590003230	S.TRA UNR9113J-(TX) [USA-01]	T	9.5/51
	1590003230	S.TRA UNR9113J-(TX) [EXP-01]		
	1590003230	S.TRA UNR9113J-(TX) [USA-02]		
	1590003230	S.TRA UNR9113J-(TX) [EXP-02]		
	1590003230	S.TRA UNR9113J-(TX) [EUR-01]		
D1	1750001070	S.DIO DAN235ETL	B	57.3/78.6
D2	1750001070	S.DIO DAN235ETL	B	50/79.7
D3	1790001621	S.DIO 1SV308(TPL3,F)	B	70.3/93.4
D4	1790001621	S.DIO 1SV308(TPL3,F)	B	67.8/93.4
D7	1750001150	S.VAR HVC383BTRF-E	B	30.8/122.3
D8	1750001150	S.VAR HVC383BTRF-E	B	30.6/112.7
D9	1750001150	S.VAR HVC383BTRF-E	B	85.6/63.5
D10	1750001150	S.VAR HVC383BTRF-E	B	85.7/53.3
D11	1790001621	S.DIO 1SV308(TPL3,F)	B	63.5/103.1
D12	1790001621	S.DIO 1SV308(TPL3,F)	B	62.7/101.1
D13	1750000711	S.VAR HVC350BTRF-E	B	87.3/66.8
D14	1750000711	S.VAR HVC350BTRF-E	B	87.1/55.4
D15	1750000711	S.VAR HVC350BTRF-E	B	32.6/125.4
D16	1750000711	S.VAR HVC350BTRF-E	B	32/114.5
D17	1720000570	S.VAR MA368(TX)	B	94.6/66.6
D18	1720000570	S.VAR MA368(TX)	B	91.4/57.7
D19	1750000520	S.DIO DAN222TL	T	59.6/39.8

M.=Mounted side (T: Mounted on the Top side, B: Mounted on the Bottom side)  
S.=Surface mount

[MAIN UNIT]

REF NO.	ORDER NO.	DESCRIPTION	M.	H/V LOCATION
D20	1790001260	S.DIO MA2S077-(TX) [USA-01]	T	38.9/57.8
	1790001260	S.DIO MA2S077-(TX) [EXP-01]		
	1790001260	S.DIO MA2S077-(TX) [USA-02]		
	1790001260	S.DIO MA2S077-(TX) [EXP-02]		
	1790001260	S.DIO MA2S077-(TX) [EUR-01]		
D21	1750000711	S.VAR HVC350BTRF-E	B	66.1/135.8
D22	1750000711	S.VAR HVC350BTRF-E	B	62.9/135.8
D24	1750000711	S.VAR HVC350BTRF-E	B	56.1/135.9
D27	1790001250	S.DIO MA2S111-(TX) [USA-01]	T	57.2/140.4
	1790001250	S.DIO MA2S111-(TX) [EXP-01]		
	1790001250	S.DIO MA2S111-(TX) [USA-02]		
	1790001250	S.DIO MA2S111-(TX) [EXP-02]		
	1790001250	S.DIO MA2S111-(TX) [EUR-01]		
D28	1750000711	S.VAR HVC350BTRF-E	B	35.9/134.4
D29	1750000711	S.VAR HVC350BTRF-E	B	37.1/134.4
D31	1750000711	S.VAR HVC350BTRF-E	B	32.4/136.5
D32	1750000711	S.VAR HVC350BTRF-E	B	32.4/135.3
D33	1790001240	S.DIO MA2S728-(TX) [USA-01]	B	37.8/144.2
	1790001240	S.DIO MA2S728-(TX) [EXP-01]		
	1790001240	S.DIO MA2S728-(TX) [USA-02]		
	1790001240	S.DIO MA2S728-(TX) [EXP-02]		
	1790001240	S.DIO MA2S728-(TX) [EUR-01]		
D34	1790001260	S.DIO MA2S077-(TX) [USA-01]	B	85.4/137.8
	1790001260	S.DIO MA2S077-(TX) [EXP-01]		
	1790001260	S.DIO MA2S077-(TX) [USA-02]		
	1790001260	S.DIO MA2S077-(TX) [EXP-02]		
	1790001260	S.DIO MA2S077-(TX) [EUR-01]		
D38	1750001360	S.DIO L709CER (9401)	B	87.8/135.6
D40	1750000370	S.DIO DA221 TL	T	112.6/77
D44	1710001061	DIO L407CDB		
D45	1790001211	S.DIO 1SS375-TL-E	B	96.3/138.1
D46	1750000520	S.DIO DAN222TL	T	13.3/131.1
D47	1750000520	S.DIO DAN222TL	T	13.2/129.1
D48	1790000660	S.DIO MA728(TX)	B	121.1/142.5
D49	1790000660	S.DIO MA728(TX)	B	140.6/133
D51	1790001250	S.DIO MA2S111-(TX) [USA-01]	T	10.5/127.1
	1790001250	S.DIO MA2S111-(TX) [EXP-01]		
	1790001250	S.DIO MA2S111-(TX) [USA-02]		
	1790001250	S.DIO MA2S111-(TX) [EXP-02]		
	1790001250	S.DIO MA2S111-(TX) [EUR-01]		
D53	1790001810	S.VAR AVR-M1005C080MTABB	T	32.5/11.5
D55	1790001810	S.VAR AVR-M1005C080MTABB	T	30.5/11.5
D56	1790001810	S.VAR AVR-M1005C080MTABB	B	33.2/22.1
D59	1790000700	DIO DSA3A1		
D61	1160000070	S.DIO DAN202K T146	T	118.4/14.3
D62	1750000431	S.DIO HSB88WSTR-E	B	68.3/123.3
D63	1790001250	S.DIO MA2S111-(TX) [USA-01]	B	34.1/20.7
	1790001250	S.DIO MA2S111-(TX) [EXP-01]		
	1790001250	S.DIO MA2S111-(TX) [USA-02]		
	1790001250	S.DIO MA2S111-(TX) [EXP-02]		
	1790001250	S.DIO MA2S111-(TX) [EUR-01]		
D64	1750000370	S.DIO DA221 TL	T	63.2/93.9
D65	1750000370	S.DIO DA221 TL	T	65.2/93.9
D66	1750000370	S.DIO DA221 TL	T	67.2/93.9
D67	1750000370	S.DIO DA221 TL	T	62.5/105.6
D68	1750000370	S.DIO DA221 TL	T	60.5/104.7
D69	1750000370	S.DIO DA221 TL	T	69.2/93.9
D70	1750000370	S.DIO DA221 TL	T	71.2/93.9
D71	1750000370	S.DIO DA221 TL	T	69.4/109.5
D72	1750000370	S.DIO DA221 TL	T	71.5/109.5
D73	1750000370	S.DIO DA221 TL	T	73.5/109.5
D74	1750000370	S.DIO DA221 TL	T	75.6/109.5
D75	1790001250	S.DIO MA2S111-(TX) [USA-01]	B	41/38.6
	1790001250	S.DIO MA2S111-(TX) [EXP-01]		
	1790001250	S.DIO MA2S111-(TX) [USA-02]		
	1790001250	S.DIO MA2S111-(TX) [EXP-02]		
	1790001250	S.DIO MA2S111-(TX) [EUR-01]		
D76	1790001250	S.DIO MA2S111-(TX) [USA-01]	B	26.4/41.3
	1790001250	S.DIO MA2S111-(TX) [EXP-01]		
	1790001250	S.DIO MA2S111-(TX) [USA-02]		
	1790001250	S.DIO MA2S111-(TX) [EXP-02]		
	1790001250	S.DIO MA2S111-(TX) [EUR-01]		
D77	1790001250	S.DIO MA2S111-(TX) [USA-01]	B	49.2/29.9
	1790001250	S.DIO MA2S111-(TX) [EXP-01]		
	1790001250	S.DIO MA2S111-(TX) [USA-02]		
	1790001250	S.DIO MA2S111-(TX) [EXP-02]		
	1790001250	S.DIO MA2S111-(TX) [EUR-01]		
D78	1730002360	S.ZEN MA8062-M(TX) [USA-01]	B	52.3/29.9
	1730002360	S.ZEN MA8062-M(TX) [EXP-01]		
	1730002360	S.ZEN MA8062-M(TX) [USA-02]		
	1730002360	S.ZEN MA8062-M(TX) [EXP-02]		
	1730002360	S.ZEN MA8062-M(TX) [EUR-01]		
F11	2020001520	CER CFWLA450KFFA-B0 (CFWS450F)		
F12	2020001460	CER CFWLA450KHFA-B0 (CFWS450HT)		
F13	2030000500	S.MON DSF753SBF 46.35 MHz (FL-401)	B	72/101
F14	2030000670	S.MON DSF753SBF 46.35 MHz (FL-420)	B	63.4/91.1
F15	2040001440	S.LC NFE31PT152Z1E9L (NFM60R20T152)	T	114.2/110.3
F16	2040001440	S.LC NFE31PT152Z1E9L (NFM60R20T152)	T	114.2/113.4
F17	2040001440	S.LC NFE31PT152Z1E9L (NFM60R20T152)	T	114.2/116.5
X1	6050012380	S.XTA CR-826 DSA535SD 15.3 MHz	B	128.6/45.3
X2	6050012380	S.XTA CR-826 DSA535SD 15.3 MHz	B	35.6/72.3
X3	6070000300	S.DIS JTBM450CX24 <JJE>	B	63.5/83.5
X4	6050012350	S.XTA CR-886 12.288 MHZ	B	52.8/38.2
X5	6050012680	S.XTA CR-858(SMD-49/18.432 MHz) <JJE>	T	46.9/52.7

[MAIN UNIT]

REF NO.	ORDER NO.	DESCRIPTION	M.	H/V LOCATION
L1	6200004660	S.COI MLF1608A 1R8K-T	B	115.6/39.2
L2	6200004660	S.COI MLF1608A 1R8K-T	B	23.6/82.4
L3	6200004480	S.COI MLF1608D R82K-T	B	39.4/79.3
L4	6200003540	S.COI MLF1608D R22K-T	B	36.9/76.9
L5	6200005671	S.COI ELJRE 12NGFA [USA-01]	B	102.7/46.7
	6200005671	S.COI ELJRE 12NGFA [EXP-01]		
	6200005661	S.COI ELJRE 10NGFA [USA-02]		
	6200005661	S.COI ELJRE 10NGFA [EXP-02]		
	6200005671	S.COI ELJRE 12NGFA [EUR-01]		
L6	6200005671	S.COI ELJRE 12NGFA	B	44.6/99.3
L8	6200004741	S.COI NLV25T-1R2J	B	28.5/121.7
L9	6200004741	S.COI NLV25T-1R2J	B	28.5/124.9
L10	6200004741	S.COI NLV25T-1R2J	B	28.5/114.1
L11	6200004741	S.COI NLV25T-1R2J	B	83.7/63.1
L12	6200004741	S.COI NLV25T-1R2J	B	83.7/54.6
L13	6200004741	S.COI NLV25T-1R2J	B	30.6/117.2
L14	6200004741	S.COI NLV25T-1R2J	B	84.2/66.2
L15	6200004741	S.COI NLV25T-1R2J	B	84.2/57.7
L18	6200009260	S.COI C3328A-8NOG 8N	B	88.7/63.1
L19	6200009260	S.COI C3328A-8NOG 8N	B	89.8/54
L20	6200009390	S.COI C3328A-8NOJ-A	B	33.2/121.7
L21	6200009390	S.COI C3328A-8NOJ-A	B	34.7/113.1
L22	6200003550	S.COI MLF1608A 4R7K-T	B	73.4/109.9
L23	6200002861	S.COI NLV25T-4R7J	B	57.6/108.9
L24	6200010740	S.COI C2520C-R27G-A	B	70/109.1
L25	6200004741	S.COI NLV25T-1R2J	B	97.1/64.6
L26	6200004741	S.COI NLV25T-1R2J	B	98.1/53.9
L27	6130002961	S.COI #617DB-1327=P3	B	68.3/117
L28	6200005711	S.COI ELJRE 27NGFA	B	62.3/123.6
L29	6200005721	S.COI ELJRE 33NGFA	B	102.6/58.6
L30	6200005721	S.COI ELJRE 33NGFA	B	46.9/116.2
L31	6200002861	S.COI NLV25T-4R7J	T	91.1/19.9
L32	6130002961	S.COI #617DB-1327=P3	B	68.3/128.7
L33	6200005671	S.COI ELJRE 12NGFA	B	47.3/107.1
L34	6200005711	S.COI ELJRE 27NGFA [USA-01]	B	61.1/117.5
	6200005711	S.COI ELJRE 27NGFA [EXP-01]		
	6200005691	S.COI ELJRE 18NGFA [USA-02]		
	6200005691	S.COI ELJRE 18NGFA [EXP-02]		
	6200005711	S.COI ELJRE 27NGFA [EUR-01]		
L35	6200005671	S.COI ELJRE 12NGFA [USA-01]	B	102.7/51.6
	6200005661	S.COI ELJRE 10NGFA [USA-02]		
	6200005661	S.COI ELJRE 10NGFA [EXP-02]		
	6200005671	S.COI ELJRE 12NGFA [EUR-01]		
L36	6200005711	S.COI ELJRE 27NGFA	B	44.3/123.1
L37	6200005711	S.COI ELJRE 27NGFA [USA-01]	B	61.1/120.1
	6200005691	S.COI ELJRE 18NGFA [EXP-01]		
	6200005691	S.COI ELJRE 18NGFA [USA-02]		
	6200005711	S.COI ELJRE 27NGFA [EXP-02]		
	6200005711	S.COI ELJRE 27NGFA [EUR-01]		
L38	6200005711	S.COI ELJRE 27NGFA	B	100/64.4
L39	6200009320	S.COI C3328A-12NG-A	B	70.8/137.3
L40	6200009320	S.COI C3328A-12NG-A	B	59.5/135.7
L41	6200009320	S.COI C3328A-12NG-A	B	51.4/136.3
L42	6200005711	S.COI ELJRE 27NGFA	B	134.7/83.8
L43	6200005711	S.COI ELJRE 27NGFA	B	142/87.1
L44	6200010290	S.COI C6328A-22NG-A [USA-01]	B	41.9/136.2
	6200010290	S.COI C6328A-22NG-A [EXP-01]		
	6200013490	S.COI C6328A-17NG-A [USA-02]		
	6200013490	S.COI C6328A-17NG-A [EXP-02]		
	6200010290	S.COI C6328A-22NG-A [EUR-01]		
L45	6200005641	S.COI ELJRE 6N8ZF	B	142.7/90.6
L46	6200005691	S.COI ELJRE 18NGFA [USA-01]	B	142/94.6
	6200005691	S.COI ELJRE 18NGFA [EXP-01]		
	6200005691	S.COI ELJRE 18NGFA [USA-02]		
	6200005691	S.COI ELJRE 18NGFA [EXP-02]		
	6200005671	S.COI ELJRE 12NGFA [EUR-01]		
L47	6200010290	S.COI C6328A-22NG-A [USA-01]	B	34.8/140.3
	6200010290	S.COI C6328A-22NG-A [EXP-01]		
	6200013490	S.COI C6328A-17NG-A [USA-02]		
	6200013490	S.COI C6328A-17NG-A [EXP-02]		
	6200010290	S.COI C6328A-22NG-A [EUR-01]		
L48	6200010100	S.COI C2012C-33NG-A	B	39.7/142.2
L49	6200010040	S.COI AS100340-10N	B	95.5/119.7
L50	6200005691	S.COI ELJRE 18NGFA	B	88/137.7
L52	6200010420	S.COI FHW1210HC 1R0JGT <JJE>	B	86.6/122.3
L53	6200010150	S.COI AS080340-15N	B	92.5/134.3
L54	6200010150	S.COI AS080340-15N	B	99.7/133.8
L55	6200010150	S.COI AS080340-15N	B	107.5/135.8
L56	6200010150	S.COI AS080340-15N	B	114.4/138.9
L57	6200010150	S.COI AS080340-15N	B	144.6/142.1
L58	6200002861	S.COI NLV25T-4R7J	T	55.4/37.5
L59	6200010420	S.COI FHW1210HC 1R0JGT <JJE>	B	147.1/146.2
L60	6200010420	S.COI FHW1210HC 1R0JGT <JJE>	B	24.5/145
L61	6200002961	S.COI NLV32T-4R7J	T	118.4/23.8
L65	6200004741	S.COI NLV25T-1R2J	B	41.3/123.3
L66	6200004741	S.COI NLV25T-1R2J	B	42.8/113.5
R1	703000570			



[MAIN UNIT]

REF NO.	ORDER NO.	DESCRIPTION	M.	H/V LOCATION
R22	7410001130	S.ARR EXB28V102JX	B	122.6/39
R23	7410001130	S.ARR EXB28V102JX	B	23.1/76.3
R25	7030004970	S.RES ERJ2GEJ 470 X (47)	B	65.3/79.4
R26	7030010040	S.RES ERJ2GEJ-JPW	T	57.8/64.5
R27	7030005120	S.RES ERJ2GEJ 102 X (1K)	T	57.8/51
R29	7030007570	S.RES ERJ2GEJ 122 X (1.2K)	B	35.8/75.5
R30	7030007340	S.RES ERJ2GEJ 153 X (15K)	B	52.8/81.1
R32	7030007340	S.RES ERJ2GEJ 153 X (15K)	B	51.2/78.3
R33	7030007340	S.RES ERJ2GEJ 153 X (15K)	B	48.4/78.2
R34	7030005240	S.RES ERJ2GEJ 473 X (47K)	T	27.1/68.1
R35	7030005240	S.RES ERJ2GEJ 473 X (47K)	T	28/68.1
R36	7030005240	S.RES ERJ2GEJ 473 X (47K)	T	28.9/68.1
R38	7030005230	S.RES ERJ2GEJ 334 X (330K)	T	27.6/70.4
R39	7030005230	S.RES ERJ2GEJ 334 X (330K)	T	28.6/70.4
R40	7030005230	S.RES ERJ2GEJ 334 X (330K)	T	29.5/70.4
R41	7030005240	S.RES ERJ2GEJ 473 X (47K)	B	68.2/78.2
R42	7030007060	S.RES ERJ2GEJ 684X (680K)	B	34.6/75.9
R43	7030007290	S.RES ERJ2GEJ 222 X (2.2K)	B	62.8/77.3
R44	7030005030	S.RES ERJ2GEJ 152 X (1.5K)	B	71.4/78.2
R45	7030004970	S.RES ERJ2GEJ 470 X (47)	B	64.6/75.5
R46	7030005000	S.RES ERJ2GEJ 471 X (470)	T	52.7/57.1
R47	7030005290	S.RES ERJ2GEJ 682 X (6.8K)	B	64.6/76.4
R48	7030005030	S.RES ERJ2GEJ 152 X (1.5K)	B	62.8/76.4
R49	7030010040	S.RES ERJ2GEJ-JPW	T	55.2/57
R52	7030004980	S.RES ERJ2GEJ 101 X (100)	B	34.1/56.4
R53	7030005210	S.RES ERJ2GEJ 822 X (8.2K)	B	16.8/57.6
R54	7030005000	S.RES ERJ2GEJ 471 X (470)	B	19.4/64.3
R56	7030004970	S.RES ERJ2GEJ 470 X (47)	B	121.9/50.4
R57	7030005040	S.RES ERJ2GEJ 472 X (4.7K)	B	62.8/75.5
R58	7030008290	S.RES ERJ2GEJ 183 X (18K)	B	56.5/49
R59	7030008290	S.RES ERJ2GEJ 183 X (18K)	B	57.4/49
R60	7030005000	S.RES ERJ2GEJ 471 X (470)	B	33.1/75.2
R62	7030005120	S.RES ERJ2GEJ 102 X (1K)	B	18.5/62.5
R63	7030005090	S.RES ERJ2GEJ 104 X (100K)	T	55.5/60
R65	7030005000	S.RES ERJ2GEJ 471 X (470)	B	125.1/47.3
R66	7030004980	S.RES ERJ2GEJ 101 X (100)	B	56.5/50.6
R68	7030005040	S.RES ERJ2GEJ 472 X (4.7K)	B	67.5/86.7
R69	7030005120	S.RES ERJ2GEJ 102 X (1K)	B	32.7/83
R71	7030005240	S.RES ERJ2GEJ 473 X (47K)	B	31/62.6
R72	7030004980	S.RES ERJ2GEJ 101 X (100)	B	57.6/44.2
R75	7030005110	S.RES ERJ2GEJ 224 X (220K)	B	39.9/71.1
R76	7030005120	S.RES ERJ2GEJ 102 X (1K)	B	91/41.5
R77	7030005580	S.RES ERJ2GEJ 560 X (56)	B	119.7/48.8
R78	7030005120	S.RES ERJ2GEJ 102 X (1K)	B	29.6/69.3
R79	7030005580	S.RES ERJ2GEJ 560 X (56)	B	32.7/79.5
R80	7030004970	S.RES ERJ2GEJ 470 X (47)	B	23.5/41.1
R81	7030007250	S.RES ERJ2GEJ 220 X (22)	B	49.9/50.5
R82	7030008400	S.RES ERJ2GEJ 182 X (1.8K)	B	56/44.2
R84	7030007290	S.RES ERJ2GEJ 222 X (2.2K)	B	95.4/45.4
R85	7030007290	S.RES ERJ2GEJ 222 X (2.2K)	B	36.9/105.6
R87	7030005090	S.RES ERJ2GEJ 104 X (100K)	B	73.7/81.1
R88	7030005530	S.RES ERJ2GEJ 100 X (10)	B	39/71.1
R89	7030008400	S.RES ERJ2GEJ 182 X (1.8K)	B	67.1/83.2
R90	7030008010	S.RES ERJ2GEJ 123 X (12K)	T	54.5/73.3
R91	7030007570	S.RES ERJ2GEJ 122 X (1.2K)	B	94.5/45.4
R92	7030005290	S.RES ERJ2GEJ 682 X (6.8K)	B	86.7/41.5
R93	7030007570	S.RES ERJ2GEJ 122 X (1.2K)	B	35.1/105.6
R94	7030005290	S.RES ERJ2GEJ 682 X (6.8K)	B	28/98.3
R97	7410001170	S.ARR EXB28V470JX	B	42.9/49.9
R98	7030005530	S.RES ERJ2GEJ 100 X (10)	B	70.7/90.4
R99	7030005110	S.RES ERJ2GEJ 224 X (220K)	B	70.7/91.3
R100	7030005600	S.RES ERJ2GEJ 273 X (27K)	B	69.1/92.3
R101	7030004980	S.RES ERJ2GEJ 101 X (100)	B	86.7/43.7
R102	7030004980	S.RES ERJ2GEJ 101 X (100)	B	31.5/105.6
R103	7030004980	S.RES ERJ2GEJ 101 X (100)	B	27.8/103.9
R104	7030005050	S.RES ERJ2GEJ 103 X (10K)	B	86.7/45.4
R105	7030005050	S.RES ERJ2GEJ 103 X (10K)	B	31.5/109
R106	7030005050	S.RES ERJ2GEJ 103 X (10K)	B	27.8/105.6
R107	7030004980	S.RES ERJ2GEJ 101 X (100)	B	90.8/45.4
R108	7030005030	S.RES ERJ2GEJ 152 X (1.5K)	B	90.8/43.7
R109	7030005090	S.RES ERJ2GEJ 104 X (100K)	B	65.7/100.1
R110	7030005810	S.RES RR0510P-152-D (1.5K)	B	31.5/103.9
R111	7030005090	S.RES ERJ2GEJ 104 X (100K)	B	37.8/105.6
R112	7030005220	S.RES ERJ2GEJ 223 X (22K)	B	86.7/47.1
R113	7030005220	S.RES ERJ2GEJ 223 X (22K)	B	27.8/107.3
R114	7030007300	S.RES ERJ2GEJ 332 X (3.3K)	B	69.4/94.8
R115	7030007300	S.RES ERJ2GEJ 332 X (3.3K)	B	66.8/96.2
R116	7030005050	S.RES ERJ2GEJ 103 X (10K)	B	90.8/48.8
R117	7030005120	S.RES ERJ2GEJ 102 X (1K)	B	90.8/47.1
R118	7030007280	S.RES ERJ2GEJ 331 X (330)	B	72.8/94.8
R119	7030007270	S.RES ERJ2GEJ 151 X (150)	B	67.2/90
R120	7030005800	S.RES RR0510P-102-D (1K)	B	31.5/107.3
R121	7030009820	S.RES RR0510P-681-D (680)	B	26.2/109
R122	7030004970	S.RES ERJ2GEJ 470 X (47)	B	56.6/33.9
R123	7030004970	S.RES ERJ2GEJ 470 X (47)	B	49.5/38.5
R124	7030005240	S.RES ERJ2GEJ 473 X (47K)	B	55.3/38.3
R125	7030007280	S.RES ERJ2GEJ 331 X (330)	B	82.6/51
R126	7030007290	S.RES ERJ2GEJ 222 X (2.2K)	B	94.5/43.7
R127	7030005700	S.RES ERJ2GEJ 274 X (270K)	T	61.2/51
R128	7030007290	S.RES ERJ2GEJ 222 X (2.2K)	B	35.1/103.9
R129	7030005240	S.RES ERJ2GEJ 473 X (47K)	B	55.3/35.1
R130	7030005240	S.RES ERJ2GEJ 473 X (47K)	B	56.2/36.7
R131	7030004980	S.RES ERJ2GEJ 101 X (100)	B	54.2/32.4
R132	7030007290	S.RES ERJ2GEJ 222 X (2.2K)	B	50.8/34.9
R133	7030007280	S.RES ERJ2GEJ 331 X (330)	B	67.5/104.4
R134	7030007270	S.RES ERJ2GEJ 151 X (150)	B	62.7/97.1
R136	7030005110	S.RES ERJ2GEJ 224 X (220K)	B	81.7/65.3
R137	7030005110	S.RES ERJ2GEJ 224 X (220K)	B	81.7/56.8
R140	7030007300	S.RES ERJ2GEJ 332 X (3.3K)	B	63.8/101.1
R142	7030007300	S.RES ERJ2GEJ 332 X (3.3K)	B	65.7/103.1
R143	7030005240	S.RES ERJ2GEJ 473 X (47K)	B	48.6/38.5
R144	7030005240	S.RES ERJ2GEJ 473 X (47K)	B	48.6/36.8
R145	7030010040	S.RES ERJ2GEJ-JPW	B	47.3/37.3
R146	7030005090	S.RES ERJ2GEJ 104 X (100K)	B	97.3/47.1

[MAIN UNIT]

REF NO.	ORDER NO.	DESCRIPTION	M.	H/V LOCATION
R147	7030005290	S.RES ERJ2GEJ 682 X (6.8K)	B	98.2/47.1
R148	7030004980	S.RES ERJ2GEJ 101 X (100)	B	59.3/106.8
R149	7030008290	S.RES ERJ2GEJ 183 X (18K)	B	97.3/48.8
R150	7030005110	S.RES ERJ2GEJ 224 X (220K)	B	91.5/66.6
R151	7030005110	S.RES ERJ2GEJ 224 X (220K)	B	88.9/58.2
R152	7030005070	S.RES ERJ2GEJ 683 X (68K)	B	65.2/107
R153	7030005000	S.RES ERJ2GEJ 471 X (470)	B	61.4/104.4
R154	7030006020	S.RES RR0510P-682-D (6.8K)	B	36.8/121.9
R155	7030006020	S.RES RR0510P-682-D (6.8K)	B	36.5/120.7
R156	7030006020	S.RES RR0510P-682-D (6.8K)	B	37.4/112.2
R157	7030005530	S.RES ERJ2GEJ 100 X (10)	B	92.4/66.6
R158	7030005530	S.RES ERJ2GEJ 100 X (10)	B	88.9/57.2
R159	7030005530	S.RES ERJ2GEJ 100 X (10)	B	65.2/106.1
R160	7030010040	S.RES ERJ2GEJ-JPW	B	36.8/123.7
R161	7030006020	S.RES RR0510P-682-D (6.8K)	B	37.6/113.5
R162	7030010040	S.RES ERJ2GEJ-JPW	B	37.6/115.3
R163	7030006020	S.RES RR0510P-682-D (6.8K)	B	92.4/62
R164	7030006020	S.RES RR0510P-682-D (6.8K)	B	92.7/52.9
R165	7030009320	S.RES ERJ2GEJ 4R7 X (4.7)	B	92.4/65.3
R166	7030009320	S.RES ERJ2GEJ 4R7 X (4.7)	B	93.1/56.3
R167	7030007250	S.RES ERJ2GEJ 220 X (22)	B	58.3/111.1
R168	7030006020	S.RES RR0510P-682-D (6.8K)	B	92.4/63.4
R169	7030006020	S.RES RR0510P-682-D (6.8K)	B	93.1/54.5
R171	7030011920	S.RES RR0510P-561-D (560)	B	41/120.7
R172	7030009820	S.RES RR0510P-681-D (680)	B	97/62
R173	7030009820	S.RES RR0510P-681-D (680)	B	97/56.5
R174	7030009820	S.RES RR0510P-681-D (680)	B	41.4/115.7
R175	7030005530	S.RES ERJ2GEJ 100 X (10)	B	73.6/108.8
R176	7030005310	S.RES ERJ2GEJ 124 X (120K)	B	100.5/56.8
R177	7030005310	S.RES ERJ2GEJ 124 X (120K)	B	44.9/114.4
R178	7030004980	S.RES ERJ2GEJ 101 X (100)	B	100.5/55.9
R179	7030004980	S.RES ERJ2GEJ 101 X (100)	B	44.9/113.5
R180	7030005050	S.RES ERJ2GEJ 103 X (10K)	B	36/109
R181	7030005050	S.RES ERJ2GEJ 103 X (10K)	B	95.4/48.8
R182	7030007300	S.RES ERJ2GEJ 332 X (3.3K)	B	68.5/107
R185	7030010040	S.RES ERJ2GEJ-JPW	B	62.3/117.5
R186	7030005120	S.RES ERJ2GEJ 102 X (1K)	T	39.2/50.7
R187	7030008010	S.RES ERJ2GEJ 123 X (12K)	T	41.5/55.9
R188	7410001150	S.ARR EXB28V471JX	T	48.5/41.1
R189	7030005090	S.RES ERJ2GEJ 104 X (100K)	T	55.6/39.5
R190	7030008010	S.RES ERJ2GEJ 123 X (12K)	T	43.1/55.9
R191	7030005000	S.RES ERJ2GEJ 471 X (470)	B	44/109.1
R192	7030005110	S.RES ERJ2GEJ 224 X (220K)	B	44.9/109.1
R194	7030004980	S.RES ERJ2GEJ 101 X (100)	B	100.5/51.7
R195	7030005110	S.RES ERJ2GEJ 224 X (220K)	B	100.5/53.4
R196	7030007260	S.RES ERJ2GEJ 330 X (33)	B	48/120.7
R197	7030005050	S.RES ERJ2GEJ 103 X (10K)	T	40.5/50.6
R198	7030007260	S.RES ERJ2GEJ 330 X (33)	B	103.7/62
R199	7030005050	S.RES ERJ2GEJ 103 X (10K)	T	67.6/57.5
R200	7030004980	S.RES ERJ2GEJ 101 X (100)	B	43.1/122.6
R201	7030005070	S.RES ERJ2GEJ 683 X (68K)	B	48/122.6
R202	7030005160	S.RES ERJ2GEJ 105 X (1M)	T	41.4/48.6
R204	7030005050	S.RES ERJ2GEJ 103 X (10K)	T	54.7/39.5
R205	7030008010	S.RES ERJ2GEJ 123 X (12K)	T	34.5/57.9
R207	7030005070	S.RES ERJ2GEJ 683 X (68K)	B	103.7/64
R208	7030010040	S.RES ERJ2GEJ-JPW	B	46.2/120.7
R209	7030005000	S.RES ERJ2GEJ 471 X (470)	T	67.6/56
R212	7410001140	S.ARR EXB28V104JX	T	52.3/41.1
R213	7030005530	S.RES ERJ2GEJ 100 X (10)	T	41.4/47.7
R214	7030004980	S.RES ERJ2GEJ 101 X (100)	B	98.9/64
R215	7030010040	S.RES ERJ2GEJ-JPW	B	100.9/62
R216	7410001140	S.ARR EXB28V104JX	T	17.3/52.4
R217	7410001140	S.ARR EXB28V104JX	T	38.6/56
R218	7030005110	S.RES ERJ2GEJ 224 X (220K)	B	65/137.9
R220	7410001140	S.ARR EXB28V104JX	T	15.2/50.7
R222	7410001140	S.ARR EXB28V104JX	T	36.1/56
R223	7030005050	S.RES ERJ2GEJ 103 X (10K)	B	64/136.3
R224	7410001150	S.ARR EXB28V471JX	T	30.4/53.1
R225	7030005110	S.RES ERJ2GEJ 224 X (220K)	B	64/137.9
R226	7030005110	S.RES ERJ2GEJ 224 X (220K)	B	57.2/136.1
R227	7410001150	S.ARR EXB28V471JX	T	42.9/28.9
R230	7410001150	S.ARR EXB28V471JX	T	28.6/50.9
R231	7030005010	S.RES ERJ2GEJ 681 X (680)	[USA-01]	B 55/138
	7030005010	S.RES ERJ2GEJ 681 X (680)	[EXP-01]	
	7030005010	S.RES ERJ2GEJ 681 X (680)	[USA-02]	
	7030005010	S.RES ERJ2GEJ 681 X (680)	[EXP-02]	
	7030007280	S.RES ERJ2GEJ 331 X (330)	[EUR-01]	
R232	7410001150	S.ARR EXB28V471JX	T	25.9/49.4
R233	7030005530	S.RES ERJ2GEJ 100 X (10)	B	54.1/136.1



[MAIN UNIT]

REF NO.	ORDER NO.	DESCRIPTION	M.	H/V LOCATION
R265	7030007280	S.RES ERJ2GEJ 331 X (330)	T	143/121.4
R266	7030005090	S.RES ERJ2GEJ 104 X (100K)	B	34.6/133.5
R267	7410001140	S.ARR EXB28V104JX	T	14.8/43.1
R268	7410001150	S.ARR EXB28V471JX	T	45.7/31.8
R269	7030007270	S.RES ERJ2GEJ 151 X (150)	B	142.6/92.6
R270	7030005050	S.RES ERJ2GEJ 103 X (10K)	B	30.6/134
R271	7030005090	S.RES ERJ2GEJ 104 X (100K)	T	23.8/26.7
R272	7410001150	S.ARR EXB28V471JX	T	17.9/32.3
R273	7410001150	S.ARR EXB28V471JX	T	17.9/35.1
R274	7030005090	S.RES ERJ2GEJ 104 X (100K)	B	31.5/134
R277	7030004980	S.RES ERJ2GEJ 101 X (100)	T	143.4/126.6
R278	7030005090	S.RES ERJ2GEJ 104 X (100K)	T	13.9/65.6
R279	7030007290	S.RES ERJ2GEJ 222 X (2.2K)	T	103.6/88.4
R280	7030004990	S.RES ERJ2GEJ 221 X (220)	T	138.4/128.2
R281	7410001150	S.ARR EXB28V471JX	T	21.3/31.8
R282	7030005090	S.RES ERJ2GEJ 104 X (100K)	T	37.8/20.3
R283	7030005100	S.RES ERJ2GEJ 154 X (150K)	T	141.5/126.6
R285	7030005050	S.RES ERJ2GEJ 103 X (10K)	T	101.6/79.5
R287	7410001140	S.ARR EXB28V104JX	T	49.7/27.7
R288	7030005110	S.RES ERJ2GEJ 224 X (220K)	T	136.8/124.7
R289	7030006070	S.RES ERJ12YJ101U (100)	B	86.9/117.5
R290	7030005110	S.RES ERJ2GEJ 224 X (220K)	T	137.2/122.6
R291	7030005040	S.RES ERJ2GEJ 472 X (4.7K)	T	139.2/121.2
R292	7030005050	S.RES ERJ2GEJ 103 X (10K)	T	139.3/128.2
R295	7030006610	S.RES ERJ2GEJ 394 X (390K)	T	136.3/122.6
R296	7030007300	S.RES ERJ2GEJ 332 X (3.3K)	T	121.8/77.2
R297	7030007300	S.RES ERJ2GEJ 332 X (3.3K)	T	122.8/77.2
R298	7030000440	S.RES MCR10EZJH 3.3K (332)	T	120.4/77.3
R299	7030004980	S.RES ERJ2GEJ 101 X (100)	B	29.1/19.4
R300	7030005530	S.RES ERJ2GEJ 100 X (10)	T	47.6/73.1
R301	7030008300	S.RES ERJ2GEJ 184 X (180K)	B	85.7/131
R303	7410001150	S.ARR EXB28V471JX	T	47.7/68.4
R304	7030005050	S.RES ERJ2GEJ 103 X (10K)	B	95.4/135.9
R306	7520000260	S.POS PRF18BB471QB1RB	B	87.3/130.2
R308	7030008010	S.RES ERJ2GEJ 123 X (12K) [USA-01]	T	140.7/128.3
	7030008010	S.RES ERJ2GEJ 123 X (12K) [EXP-01]		
	7030008010	S.RES ERJ2GEJ 123 X (12K) [USA-02]		
	7030008010	S.RES ERJ2GEJ 123 X (12K) [EXP-02]		
	7030007340	S.RES ERJ2GEJ 153 X (15K) [EUR-01]		
R309	7030005040	S.RES ERJ2GEJ 472 X (4.7K)	T	102.2/75.7
R313	7030005050	S.RES ERJ2GEJ 103 X (10K)	T	103.5/77.8
R315	7030005700	S.RES ERJ2GEJ 274 X (270K)	B	98.6/137.3
R316	7030005050	S.RES ERJ2GEJ 103 X (10K)	T	11.2/128.2
R320	7030005090	S.RES ERJ2GEJ 104 X (100K)	T	15/124.1
R321	7030003320	S.RES ERJ3GEYJ 101 V (100)	B	119.5/142.1
R322	7030007350	S.RES ERJ2GEJ 393 X (39K)	B	119.4/144.2
R324	7030005050	S.RES ERJ2GEJ 103 X (10K)	B	31.3/12
R325	7030005120	S.RES ERJ2GEJ 102 X (1K)	B	32.3/12
R326	7030005240	S.RES ERJ2GEJ 473 X (47K)	T	13.2/125.7
R327	7030000220	S.RES MCR10EZJH 47 (470)	B	119.7/132.8
R328	7030000260	S.RES MCR10EZJH 100 (101)	B	139.3/144.3
R331	7030004980	S.RES ERJ2GEJ 101 X (100)	T	12/120
R332	7030003320	S.RES ERJ3GEYJ 101 V (100)	B	139.5/135
R333	7030007350	S.RES ERJ2GEJ 393 X (39K)	B	139.3/131.4
R334	7030005651	S.RES ERA3YKD 304V (300K)	T	57.8/30.5
R335	7030005871	S.RES ERA3YKD 104V (100K)	T	55.9/29.7
R336	7030005110	S.RES ERJ2GEJ 224 X (220K)	T	12/120.9
R337	7030005110	S.RES ERJ2GEJ 224 X (220K)	T	13.2/120.6
R339	7030005090	S.RES ERJ2GEJ 104 X (100K)	T	12/125.3
R341	7030005050	S.RES ERJ2GEJ 103 X (10K)	B	33.3/12
R342	7030005090	S.RES ERJ2GEJ 104 X (100K)	B	45.3/56.9
R346	7410001150	S.ARR EXB28V471JX	T	43.5/73.8
R347	7030005000	S.RES ERJ2GEJ 471 X (470)	T	9.8/132.9
R348	7030000620	S.RES MCR10EZJH 100 K (104)	B	147.2/150.9
R349	7030000620	S.RES MCR10EZJH 100 K (104)	B	26/149.7
R350	7030003560	S.RES ERJ3GEYJ 103 V (10K)	B	6.4/131
R352	7030005040	S.RES ERJ2GEJ 472 X (4.7K)	T	10.2/125.3
R353	7030005240	S.RES ERJ2GEJ 473 X (47K)	B	55.8/56.9
R354	7030005700	S.RES ERJ2GEJ 274 X (270K)	T	125.2/103.6
R355	7030005090	S.RES ERJ2GEJ 104 X (100K)	T	129.2/103.6
R356	7030005050	S.RES ERJ2GEJ 103 X (10K)	T	9.8/134.5
R357	7030003560	S.RES ERJ3GEYJ 103 V (10K)	B	10.1/150.2
R362	7540000290	ABS ERZV10D220	T	
R364	7030005110	S.RES ERJ2GEJ 224 X (220K)	T	65.1/71.2
R365	7030005050	S.RES ERJ2GEJ 103 X (10K)	T	7.4/120.7
R366	7030007290	S.RES ERJ2GEJ 222 X (2.2K)	T	7/123.5
R367	7030004980	S.RES ERJ2GEJ 101 X (100)	T	9.7/117.3
R368	7030008300	S.RES ERJ2GEJ 184 X (180K)	T	8.5/117.8
R369	7030005230	S.RES ERJ2GEJ 334 X (330K)	T	9.7/118.2
R370	7030008280	S.RES ERJ2GEJ 271 X (270)	T	6.1/120.7
R371	7030010040	S.RES ERJ2GEJ-JPW	T	5/117.3
R372	7030005000	S.RES ERJ2GEJ 471 X (470)	T	115.3/15.8
R373	7030005050	S.RES ERJ2GEJ 103 X (10K)	T	115.3/14
R374	7030000140	S.RES MCR10EZJH 10 (100)	T	111.2/12.3
R375	7030010040	S.RES ERJ2GEJ-JPW	T	100.1/16.3
R376	7030004980	S.RES ERJ2GEJ 101 X (100)	B	62.3/122.2
R377	7030005000	S.RES ERJ2GEJ 471 X (470)	B	62.3/124.7
R378	7030005210	S.RES ERJ2GEJ 822 X (8.2K)	B	63.2/126.1
R379	7030005210	S.RES ERJ2GEJ 822 X (8.2K)	B	59.6/126.1
R380	7030007260	S.RES ERJ2GEJ 330 X (33)	B	57.8/123.7
R381	7030004990	S.RES ERJ2GEJ 221 X (220) [USA-01]	B	61.4/126.1
	7030004990	S.RES ERJ2GEJ 221 X (220) [EXP-01]		
	7030007270	S.RES ERJ2GEJ 151 X (150) [USA-02]		
	7030007270	S.RES ERJ2GEJ 151 X (150) [EXP-02]		
	7030004990	S.RES ERJ2GEJ 221 X (220) [EUR-01]		
R424	7410001150	S.ARR EXB28V471JX	T	46.3/42.9
R425	7410001150	S.ARR EXB28V471JX	T	36.8/23
R426	7410001150	S.ARR EXB28V471JX	T	47.8/33.9
R427	7030005000	S.RES ERJ2GEJ 471 X (470)	T	25.5/26.7
R428	7410001140	S.ARR EXB28V104JX	T	48/22.7
R429	7410001140	S.ARR EXB28V104JX	T	49.7/30.2
R430	7410001140	S.ARR EXB28V104JX	T	52.3/43.6
R431	7410001150	S.ARR EXB28V471JX	T	17.9/40.3
R432	7410001140	S.ARR EXB28V104JX	T	15.2/48.2

[MAIN UNIT]

REF NO.	ORDER NO.	DESCRIPTION	M.	H/V LOCATION
R433	7410001150	S.ARR EXB28V471JX	T	39.6/23
R434	7410000750	S.ARR EXB-V4V 104JV (100K)	B	36.8/48.2
R435	7410001140	S.ARR EXB28V104JX	B	39.1/47.8
R436	7410001140	S.ARR EXB28V104JX	B	44.3/41.2
R438	7410001140	S.ARR EXB28V104JX	B	34.4/47.7
R443	7030005000	S.RES ERJ2GEJ 471 X (470)	T	60.4/59.2
R444	7030005240	S.RES ERJ2GEJ 473 X (47K)	B	13.5/33.6
R445	7030005240	S.RES ERJ2GEJ 473 X (47K)	B	13.5/36.1
R446	7030005240	S.RES ERJ2GEJ 473 X (47K)	B	13.5/37.4
R447	7030005090	S.RES ERJ2GEJ 104 X (100K)	T	50.2/19.2
R448	7030005090	S.RES ERJ2GEJ 104 X (100K)	T	49.3/19.2
R449	7030005170	S.RES ERJ2GEJ 474 X (470K)	T	39.5/19.2
R450	7030005050	S.RES ERJ2GEJ 103 X (10K)	T	50.2/16.5
R453	7030005120	S.RES ERJ2GEJ 102 X (1K)	T	52/13.9
R454	7030005120	S.RES ERJ2GEJ 102 X (1K)	B	94.9/27.2
R455	7030005010	S.RES ERJ2GEJ 681 X (680)	B	124.9/2.7
R456	7030005120	S.RES ERJ2GEJ 102 X (1K)	B	109.9/2.7
R467	7030005240	S.RES ERJ2GEJ 473 X (47K)	B	38/44.6
R468	7410001140	S.ARR EXB28V104JX	B	31.8/48.5
R469	7030005090	S.RES ERJ2GEJ 104 X (100K)	B	32.6/44.6
R470	7030005090	S.RES ERJ2GEJ 104 X (100K)	T	10.9/20.2
R471	7030005090	S.RES ERJ2GEJ 104 X (100K)	B	47.7/44.2
R472	7030005240	S.RES ERJ2GEJ 473 X (47K)	B	4.8/36.1
R473	7030005090	S.RES ERJ2GEJ 104 X (100K)	B	46.2/44.6
R474	7030005530	S.RES ERJ2GEJ 100 X (10)	B	15.5/55.3
R475	7030005240	S.RES ERJ2GEJ 473 X (47K)	B	9/56.2
R476	7030005090	S.RES ERJ2GEJ 104 X (100K)	B	15/53.5
R477	7030005080	S.RES ERJ2GEJ 823 X (82K)	B	15/52.6
R478	7030005050	S.RES ERJ2GEJ 103 X (10K)	B	9.1/54.7
R479	7030005110	S.RES ERJ2GEJ 224 X (220K)	T	64.2/69.6
R480	7030005050	S.RES ERJ2GEJ 103 X (10K)	B	15.6/61.1
R481	7030005050	S.RES ERJ2GEJ 103 X (10K)	B	16.5/59.9
R482	7410001150	S.ARR EXB28V471JX	T	19.6/45.1
R483	7030005090	S.RES ERJ2GEJ 104 X (100K)	T	31.2/56.5
R484	7030005090	S.RES ERJ2GEJ 104 X (100K)	B	28.8/50.9
R485	7410001150	S.ARR EXB28V471JX	T	67.9/96.9
R486	7410001150	S.ARR EXB28V471JX	T	64.8/105.4
R487	7410001150	S.ARR EXB28V471JX	T	72.8/105.4
R488	7030008400	S.RES ERJ2GEJ 182 X (1.8K)	T	9.5/54.9
R489	7030004980	S.RES ERJ2GEJ 101 X (100)	B	24.1/58.7
R490	7030008290	S.RES ERJ2GEJ 183 X (18K)	B	28.2/58.4
R491	7030004980	S.RES ERJ2GEJ 101 X (100)	B	26.1/51.2
R492	7030005240	S.RES ERJ2GEJ 473 X (47K)	B	29.8/58.8
R493	7030010040	S.RES ERJ2GEJ-JPW	T	11.3/19
R494	7030005000	S.RES ERJ2GEJ 471 X (470)	T	73.2/98.2
R495	7030005100	S.RES ERJ2GEJ 154 X (150K)	T	55.2/55.3
R496	7030005070	S.RES ERJ2GEJ 683 X (68K)	T	52.7/56.2
R497	7030005700	S.RES ERJ2GEJ 274 X (270K)	T	52.7/55.3
R498	7030005600	S.RES ERJ2GEJ 273 X (27K)	B	61.4/103.1
R499	7030004980	S.RES ERJ2GEJ 101 X (100)	T	24.4/57
R500	7030005600	S.RES ERJ2GEJ 273 X (27K)	T	21.2/57.5
R501	7030005220	S.RES ERJ2GEJ 223 X (22K)	T	22.8/53.8
R502	7030005090	S.RES ERJ2GEJ 104 X (100K)	T	28/55
R503	7030007350	S.RES ERJ2GEJ 393 X (39K)	T	55.5/58.4
R505	7030010040	S.RES ERJ2GEJ-JPW	T	113.4/18.3
R506	7030005110	S.RES ERJ2GEJ 224 X (220K)	T	113.4/19.3
R507	7030005090	S.RES ERJ2GEJ 104 X (100K)	T	115/19.3
R508	7030010040	S.RES ERJ2GEJ-JPW	T	144.6/119.6
R509	7030005050	S.RES ERJ2GEJ 103 X (10K)	B	33.3/15.2
R510	7030007350	S.RES ERJ2GEJ 393 X (39K)	B	29/14.1
R511	7030005050	S.RES ERJ2GEJ 103 X (10K)	B	29.1/18.5
R512	7030005050	S.RES ERJ2GEJ 103 X (10K)	B	30.8/18.5
R513	7030007280	S.RES ERJ2GEJ 331 X (330)	B	72.3/90.4
R530	7030005240	S.RES ERJ2GEJ 473 X (47K)	T	62.5/66.3
R531	7030007290	S.RES ERJ2GEJ 222 X (2.2K)	B	64.6/78.2
R532	7030005000	S.RES ERJ2GEJ 471 X (470)	B	45.1/37.1
R533	7030005090	S.RES ERJ2GEJ 104 X (100K)	T	57.2/18.4
R534	7030005600	S.RES ERJ2GEJ 273 X (27K)	B	45.3/58.6
R535	7030004980	S.RES ERJ2GEJ 101 X (100)	B	55.8/55.3
R536	7030005600	S.RES ERJ2GEJ 273 X (27K)	B	55.8/58.6
R537	7030010040	S.RES ERJ2GEJ-JPW	B	41.6/41.2
R539	7030005100	S.RES ERJ2GEJ 154 X (150K)	T	64.2/71.2
R540	7030005090	S.RES ERJ2GEJ 104 X (100K)	T	90.6/17.9
R541	7030005220	S.RES ERJ2GEJ 223 X (22K)	T	28.9/55
R542	7030005110	S.RES ERJ2GEJ 224 X (220K)	B	39.9/72.7
R543	7030005080	S.RES ERJ2GEJ 823 X (82K)	B	40.8/71.1
C1	4030017420	S.CER ECJ0EC1H470J	B	120.7/39
C2	4030017420	S.CER ECJ0EC1H470J	B	22.9/78.1
C3	4030016930	S.CER ECJ0EB1A104K	B	

[MAIN UNIT]

REF NO.	ORDER NO.	DESCRIPTION	M.	H/V LOCATION
C27	4030017460	S.CER ECJ0EB1E102K	B	23.8/80.3
C28	4030016930	S.CER ECJ0EB1A104K	B	53.3/77.9
C30	4030017460	S.CER ECJ0EB1E102K	T	59.8/67
C31	4030016930	S.CER ECJ0EB1A104K	T	60.5/53
C32	4030017590	S.CER ECJ0EC1H070C	B	38.4/79.1
C33	4030016930	S.CER ECJ0EB1A104K	T	58.9/67
C34	4030017570	S.CER ECJ0EC1H040B	B	37.2/78.7
C35	4030016930	S.CER ECJ0EB1A104K	B	38.3/76
C36	4030017500	S.CER ECJ0EC1H560J	B	37.2/79.6
C37	4030016930	S.CER ECJ0EB1A104K	B	48.4/79.8
C38	4030016930	S.CER ECJ0EB1A104K	B	69.8/78.2
C39	4030017360	S.CER ECJ0EC1H030B	B	71.4/77.3
C40	4030017760	S.CER ECJ0EB1H222K	B	68.2/77.3
C41	4030018860	S.CER ECJ0EB0J105K	B	31/58.2
C42	4030017760	S.CER ECJ0EB1H222K	B	68.2/76.4
C43	4030016930	S.CER ECJ0EB1A104K	B	55.6/49
C44	4030018860	S.CER ECJ0EB0J105K	B	35.7/56.4
C45	4030016950	S.CER ECJ0EB1A473K	B	34.5/55.2
C47	4030017460	S.CER ECJ0EB1E102K	B	64.6/77.3
C48	4030016930	S.CER ECJ0EB1A104K	T	52.7/54.4
C49	4030018860	S.CER ECJ0EB0J105K	B	15.6/58.3
C50	4030016930	S.CER ECJ0EB1A104K	B	130.8/48.4
C51	4030017620	S.CER ECJ0EC1H100C	B	125.1/45.3
C52	4030017420	S.CER ECJ0EC1H470J	B	120.6/48.8
C53	4030017420	S.CER ECJ0EC1H470J	B	32.7/78.4
C54	4030017660	S.CER ECJ0EC1H4330J	B	32.7/77.3
C56	4030016950	S.CER ECJ0EB1A473K	B	31.9/59.1
C59	4030017430	S.CER ECJ0EC1H101J	B	32.7/76.4
C60	4030017620	S.CER ECJ0EC1H100C	B	32.3/72.9
C61	4030018900	S.CER ECJ0EB0J474K	B	18/63.8
C62	4030016930	S.CER ECJ0EB1A104K	B	33.6/55.2
C63	4030016930	S.CER ECJ0EB1A104K	T	55.5/61.6
C66	4030017430	S.CER ECJ0EC1H101J	B	123.5/48.4
C67	4030017460	S.CER ECJ0EB1E102K	B	67.5/87.7
C69	4030016930	S.CER ECJ0EB1A104K	B	29.8/63
C70	4030017460	S.CER ECJ0EB1E102K	B	64.3/79.4
C71	4030016930	S.CER ECJ0EB1A104K	B	57.6/43.3
C72	4030018910	S.CER C1608 JB 0J 475K-T	B	29.3/61.9
C73	4030017460	S.CER ECJ0EB1E102K	B	96.3/45.4
C75	4030017460	S.CER ECJ0EB1E102K	B	36/105.6
C77	4030016930	S.CER ECJ0EB1A104K	T	53.9/57.7
C78	4030017460	S.CER ECJ0EB1E102K	B	119.7/50.4
C79	4030017460	S.CER ECJ0EB1E102K	B	34.3/79.5
C80	4030017350	S.CER ECJ0EC1H020B [USA-01]	B	102.4/45.6
	4030017350	S.CER ECJ0EC1H020B [EXP-01]		
	4030017550	S.CER ECJ0EC1H1R5B [USA-02]		
	4030017550	S.CER ECJ0EC1H1R5B [EXP-02]		
C81	4030017350	S.CER ECJ0EC1H020B [EUR-01]	B	42.2/99.6
	4030017350	S.CER ECJ0EC1H020B [USA-01]		
	4030017350	S.CER ECJ0EC1H020B [EXP-01]		
	4030017550	S.CER ECJ0EC1H1R5B [USA-02]		
	4030017550	S.CER ECJ0EC1H1R5B [EXP-02]		
	4030017350	S.CER ECJ0EC1H020B [EUR-01]		
C82	4550006250	S.TAN TEESVA 1A 106M8R	B	61.1/79.2
C83	4030017460	S.CER ECJ0EB1E102K	B	71.7/86.7
C84	4030017420	S.CER ECJ0EC1H470J	B	74.7/81.1
C85	4030017590	S.CER ECJ0EC1H070C	B	56/43.3
C86	4030016930	S.CER ECJ0EB1A104K	B	51.7/47.1
C87	4030018910	S.CER C1608 JB 0J 475K-T	B	54.3/48.4
C88	4030017770	S.CER ECJ0EB1E332K	B	86.7/40.6
C89	4030017770	S.CER ECJ0EB1E332K	B	28/99.3
C90	4030017680	S.CER ECJ0EC1H820J	B	69.1/86.7
C91	4030016930	S.CER ECJ0EB1A104K	T	60.7/66.3
C92	4030016790	S.CER ECJ0EB1C103K	B	72.7/88
C93	4030017460	S.CER ECJ0EB1E102K	B	70/87.9
C96	4030018910	S.CER C1608 JB 0J 475K-T	B	49.2/48.9
C97	4030016930	S.CER ECJ0EB1A104K	B	57.4/50.6
C98	4030017460	S.CER ECJ0EB1E102K	B	35.1/107.3
C99	4030017460	S.CER ECJ0EB1E102K	B	40.8/72.7
C101	4030017620	S.CER ECJ0EC1H100C	B	37.7/63.2
C102	4550000560	S.TAN TEESVA 1V 334M8R	B	84.7/42.7
C103	4550003260	S.TAN TEESVA 1V 684M8R	B	26.2/100.4
C104	4030016930	S.CER ECJ0EB1A104K	B	39.9/74.5
C105	4030017520	S.CER ECJ0EC1HOR3B	B	103.2/47.8
C106	4030017340	S.CER ECJ0EC1H010B	B	47/100.1
C107	4030017590	S.CER ECJ0EC1H070C	B	72.3/89.5
C108	4030017460	S.CER ECJ0EB1E102K	B	94.5/47.1
C109	4030017530	S.CER ECJ0EC1HOR5B	B	101.9/48.3
C110	4030017530	S.CER ECJ0EC1HOR5B	B	46.5/101.4
C111	4030016790	S.CER ECJ0EB1C103K	B	70.7/92.3
C112	4550000270	S.TAN TEESVA 1E 474M8R	B	84.7/47.9
C113	4550000270	S.TAN TEESVA 1E 474M8R	B	26.2/105.6
C114	4030017520	S.CER ECJ0EC1HOR3B	B	103.2/49.6
C115	4030017550	S.CER ECJ0EC1H1R5B [USA-01]	B	47/102.8
	4030017550	S.CER ECJ0EC1H1R5B [EXP-01]		
	4030017340	S.CER ECJ0EC1H010B [USA-02]		
	4030017340	S.CER ECJ0EC1H010B [EXP-02]		
	4030017550	S.CER ECJ0EC1H1R5B [EUR-01]		
C116	4030017460	S.CER ECJ0EB1E102K	B	70.7/89.5
C117	4030016790	S.CER ECJ0EB1C103K	B	69.1/90.4
C118	4030016790	S.CER ECJ0EB1C103K	B	69.1/91.3
C121	4030016790	S.CER ECJ0EB1C103K	B	71.1/94.8
C122	4030016790	S.CER ECJ0EB1C103K	B	67.2/91.6
C123	4030016930	S.CER ECJ0EB1A104K	B	67.5/100.1
C124	4030016930	S.CER ECJ0EB1A104K	B	48.5/50.5
C125	4030016790	S.CER ECJ0EB1C103K	B	95.4/43.7
C126	4030016790	S.CER ECJ0EB1C103K	B	57.2/35.1
C127	4030016790	S.CER ECJ0EB1C103K	B	36/103.9
C133	4030017590	S.CER ECJ0EC1H070C	B	59.4/92.8
C134	4550003260	S.TAN TEESVA 1V 684M8R	B	26.2/112.4
C135	4030016930	S.CER ECJ0EB1A104K	B	37.8/103.9
C136	4030016930	S.CER ECJ0EB1A104K	B	50.4/36.8
C137	4030017620	S.CER ECJ0EC1H100C	B	56.2/38.3
C138	4030017640	S.CER ECJ0EC1H150J	B	75.8/101.1

[MAIN UNIT]

REF NO.	ORDER NO.	DESCRIPTION	M.	H/V LOCATION
C139	4030017650	S.CER ECJ0EC1H270J	B	59.4/91.9
C140	4030016930	S.CER ECJ0EB1A104K	B	55.3/36.7
C141	4550000270	S.TAN TEESVA 1E 474M8R	B	82.6/47.9
C144	4550006250	S.TAN TEESVA 1A 106M8R	B	94.7/41.5
C145	4030017420	S.CER ECJ0EC1H470J	B	50.4/38.5
C146	4030017460	S.CER ECJ0EB1E102K	B	56.2/35.1
C147	4550006250	S.TAN TEESVA 1A 106M8R	B	33.3/100.4
C149	4030016790	S.CER ECJ0EB1C103K	B	69.4/95.7
C150	4030016790	S.CER ECJ0EB1C103K	B	65.7/97.3
C151	4030017610	S.CER ECJ0EC1H090C	B	61.7/97.1
C152	4030016930	S.CER ECJ0EB1A104K	B	55.3/32.4
C153	4030017380	S.CER ECJ0EC1H050B	B	49.8/34.9
C154	4030017420	S.CER ECJ0EC1H470J	B	26.5/120.6
C155	4030017460	S.CER ECJ0EB1E102K	B	26.5/123.2
C156	4030017420	S.CER ECJ0EC1H470J	B	28.5/111.5
C157	4030017460	S.CER ECJ0EB1E102K	B	28/117.2
C158	4030017420	S.CER ECJ0EC1H470J	B	81.7/62.1
C159	4030017420	S.CER ECJ0EC1H470J	B	81.7/53.6
C160	4030016790	S.CER ECJ0EB1C103K	B	65.7/104.4
C161	4030016790	S.CER ECJ0EB1C103K	B	62.7/98.9
C162	4030016930	S.CER ECJ0EB1A104K	B	81.7/67.1
C163	4030016930	S.CER ECJ0EB1A104K	B	81.7/58.6
C164	4030016930	S.CER ECJ0EB1A104K	B	49.5/36.8
C165	4030017460	S.CER ECJ0EB1E102K	B	81.7/66.2
C166	4030017460	S.CER ECJ0EB1E102K	B	81.7/57.7
C167	4030017460	S.CER ECJ0EB1E102K	B	97.3/45.4
C168	4030017380	S.CER ECJ0EC1H050B	B	32.6/124.3
C169	4030017620	S.CER ECJ0EC1H100C [USA-01]	B	30.8/124.4
	4030017620	S.CER ECJ0EC1H100C [EXP-01]		
	4030017570	S.CER ECJ0EC1H040B [USA-02]		
	4030017570	S.CER ECJ0EC1H040B [EXP-02]		
	4030017620	S.CER ECJ0EC1H100C [EUR-01]		
C170	4030017580	S.CER ECJ0EC1H060C	B	30.6/114.4
C171	4030017630	S.CER ECJ0EC1H120J [USA-01]	B	30.6/115.3
	4030017630	S.CER ECJ0EC1H120J [EXP-01]		
	4030017380	S.CER ECJ0EC1H050B [USA-02]		
	4030017380	S.CER ECJ0EC1H050B [EXP-02]		
	4030017630	S.CER ECJ0EC1H120J [EUR-01]		
C172	4030017580	S.CER ECJ0EC1H060C	B	87.8/65.7
	4030017580	S.CER ECJ0EC1H060C [EXP-01]		
	4030017570	S.CER ECJ0EC1H040B [USA-02]		
	4030017570	S.CER ECJ0EC1H040B [EXP-02]		
	4030017580	S.CER ECJ0EC1H060C [EUR-01]		
C173	4030017630	S.CER ECJ0EC1H120J [USA-01]	B	86.5/65.3
	4030017630	S.CER ECJ0EC1H120J [EXP-01]		
	4030017620	S.CER ECJ0EC1H100C [USA-02]		
	4030017620	S.CER ECJ0EC1H100C [EXP-02]		
C174	4030017590	S.CER ECJ0EC1H070C [USA-01]	B	85.7/55
	4030017590	S.CER ECJ0EC1H070C [EXP-01]		
	4030017580	S.CER ECJ0EC1H060C [USA-02]		
	4030017580	S.CER ECJ0EC1H060C [EXP-02]		
	4030017590	S.CER ECJ0EC1H070C [EUR-01]		
C175	4030017390	S.CER ECJ0EC1H180J [USA-01]	B	85.7/55.9
	4030017390	S.CER ECJ0EC1H180J [EXP-01]		
	4030017590	S.CER ECJ0EC1H070C [USA-02]		
	4030017590	S.CER ECJ0EC1H070C [EXP-02]		
	4030017390	S.CER ECJ0EC1H180J [EUR-01]		
C176	4030018860	S.CER ECJ0EB0J105K	T	62.9/51
C177	4030017380	S.CER ECJ0EC1H050B [USA-01]	B	35.6/120.7
	4030017380	S.CER ECJ0EC1H050B [EXP-01]		
	4030017350	S.CER ECJ0EC1H020B [USA-02]		
	4030017350	S.CER ECJ0EC1H020B [EXP-02]		
	4030017380	S.CER ECJ0EC1H050B [EUR-01]		
C178	4030017580	S.CER ECJ0EC1H060C	B	32/112.2
	4030017580	S.CER ECJ0EC1H060C [EXP-01]		
	4030017360	S.CER ECJ0EC1H030B [USA-02]		
	4030017360	S.CER ECJ0EC1H030B [EXP-02]		
	4030017580	S.CER ECJ0EC1H060C [EUR-01]		
C179	4030017420	S.CER ECJ0EC1H470J	T	14.9/129.1
C180	4030017600	S.CER ECJ0EC1H080C [USA-01]	B	91.5/62
	4030017600	S.CER ECJ0EC1H080C [EXP-01]		
	4030017570	S.CER ECJ0EC1H040B [USA-02]		
	4030017570	S.CER ECJ0EC1H040B [EXP-02]		
	4030017600	S.CER ECJ0EC1H080C [EUR-01]		
C181	4030017590	S.CER ECJ0EC1H070C [USA-01]	B	87.1/52.9
	4030017590	S.CER ECJ0EC1H070C [EXP-01]		
	4030017380	S.CER ECJ0EC1H050B [USA-02]		
	4030017380	S.CER ECJ0EC1H050B [EXP-02]		
	4030017590	S.CER ECJ0EC1H070C [EUR-01]		
C182	4030016790	S.CER ECJ0EB1C103K	B	63.1/104.4
C183	4030017420	S.CER ECJ0EC1H470J	T	14.9/131.3
C184	4030017620	S.CER ECJ0EC1H100C	B	34.9/124.3
C185	4030017630	S.CER ECJ0EC1H120J [USA-01]	B	35.4/115.3
	4030017630	S.CER ECJ0EC1H120J [EXP-01]		
	4030017610	S.CER ECJ0EC1H090C [USA-02]		
	4030017610	S.CER ECJ0EC1H090C [EXP-02]		
	4030017630	S.CER ECJ0EC1H120J [EUR-01]		
C186	4030017420	S.CER ECJ0EC1H470J	B	98.2/48.8
C187	4030017540	S.CER ECJ0EC1HR75B [USA-01]	B	89.4/66.8
	4030017540	S.CER ECJ0EC1HR75B [EXP-01]		
	4030017530	S.CER ECJ0EC1HOR5B [USA-02]		
	4030017530	S.CER ECJ0EC1HOR5B [EXP-02]		
	4030017540	S.CER ECJ0EC1HR75B [EUR-01]		
C188	4030017360	S.CER ECJ		

[MAIN UNIT]

REF NO.	ORDER NO.	DESCRIPTION	M.	H/V LOCATION
C191	4030017380	S.CER ECJ0EC1H050B	[USA-01]	B 89.4/65.7
	4030017380	S.CER ECJ0EC1H050B	[EXP-01]	
	4030017640	S.CER ECJ0EC1H150J	[USA-02]	
	4030017640	S.CER ECJ0EC1H150J	[EXP-02]	
	4030017380	S.CER ECJ0EC1H050B	[EUR-01]	
C192	4030017640	S.CER ECJ0EC1H150J	[USA-01]	B 90.5/56.3
	4030017640	S.CER ECJ0EC1H150J	[EXP-01]	
	4030017600	S.CER ECJ0EC1H080C	[USA-02]	
	4030017600	S.CER ECJ0EC1H080C	[EXP-02]	
	4030017640	S.CER ECJ0EC1H150J	[EUR-01]	
C193	4030017460	S.CER ECJ0EB1E102K		B 61.4/107.1
C194	4030017580	S.CER ECJ0EC1H060C	[USA-01]	B 36.8/122.8
	4030017580	S.CER ECJ0EC1H060C	[EXP-01]	
	4030017600	S.CER ECJ0EC1H080C	[USA-02]	
	4030017600	S.CER ECJ0EC1H080C	[EXP-02]	
	4030017580	S.CER ECJ0EC1H060C	[EUR-01]	
C195	4030017630	S.CER ECJ0EC1H120J		B 40.1/120.7
C196	4030017620	S.CER ECJ0EC1H100C		B 37.6/114.4
C197	4030017640	S.CER ECJ0EC1H150J		B 41/112.2
C198	4030016790	S.CER ECJ0EB1C103K		B 60.5/107.1
C200	4030017570	S.CER ECJ0EC1H040B		B 92.4/64.3
C201	4030017620	S.CER ECJ0EC1H100C		B 96/62
C202	4030017610	S.CER ECJ0EC1H090C		B 93.1/55.4
C203	4030017390	S.CER ECJ0EC1H180J		B 96.3/52.9
C204	4550006250	S.TAN TEESVA 1A 106M8R		T 81.7/17
C205	4550006250	S.TAN TEESVA 1A 106M8R		T 85.1/17
C206	4550006250	S.TAN TEESVA 1A 106M8R		T 88.8/16.7
C208	4030017490	S.CER C1608 JB 1A 105K-T		T 80/16.6
C209	4030017490	S.CER C1608 JB 1A 105K-T		T 83.4/16.6
C210	4030017490	S.CER C1608 JB 1A 105K-T		T 86.9/16.3
C211	4030016930	S.CER ECJ0EB1A104K		B 38.3/120.7
C212	4030016790	S.CER ECJ0EB1C103K		B 39.2/112.2
C213	4030017660	S.CER ECJ0EC1H330J		B 68.5/106.1
C214	4030017460	S.CER ECJ0EB1E102K		B 66.8/107
C215	4030017530	S.CER ECJ0EC1H0R5B		B 41.9/120.7
C216	4030017520	S.CER ECJ0EC1H0R3B		B 42.6/115.7
C217	4030017460	S.CER ECJ0EB1E102K		B 39.2/120.7
C218	4030017460	S.CER ECJ0EB1E102K		B 40.1/112.2
C219	4030016790	S.CER ECJ0EB1C103K		B 94.2/62
C220	4030017530	S.CER ECJ0EC1H0R5B		B 98.2/61.3
C221	4030016790	S.CER ECJ0EB1C103K		B 94.5/52.9
C222	4030017530	S.CER ECJ0EC1H0R5B		B 98.2/57.1
C224	4030017460	S.CER ECJ0EB1E102K		B 95.1/62
C225	4030017460	S.CER ECJ0EB1E102K		B 95.4/52.9
C228	4030017490	S.CER C1608 JB 1A 105K-T		T 79.8/24.4
C229	4030017490	S.CER C1608 JB 1A 105K-T		T 83.3/24.4
C230	4030017490	S.CER C1608 JB 1A 105K-T		T 86.8/24.4
C231	4550005980	S.TAN TEESVA 1A 475M8R		T 81.6/25.6
C232	4550005980	S.TAN TEESVA 1A 475M8R		T 85.1/25.6
C233	4550005980	S.TAN TEESVA 1A 475M8R		T 88.5/25.6
C235	4030017030	S.CER ECJ0EB1A273K		T 41/55
C236	4030017730	S.CER ECJ0EB1E471K		B 100.5/55
C237	4030017460	S.CER ECJ0EB1E102K		B 100.5/60.4
C238	4030017730	S.CER ECJ0EB1E471K		B 44.9/112.6
C239	4030017460	S.CER ECJ0EB1E102K		B 44.9/118
C240	4510008540	S.ELLE EEE1CA100SR		T 95.1/22.3
C241	4030017350	S.CER ECJ0EC1H020B		B 68.3/120.9
C242	4030016790	S.CER ECJ0EB1C103K		B 68.7/111.2
C243	4030017460	S.CER ECJ0EB1E102K		B 70.3/106.1
C244	4030016790	S.CER ECJ0EB1C103K		B 70.3/107
C245	4030017460	S.CER ECJ0EB1E102K		B 91.5/59.6
C246	4030017580	S.CER ECJ0EC1H060C		B 46.9/113.5
C247	4030017460	S.CER ECJ0EB1E102K		B 43.1/109.1
C248	4030017460	S.CER ECJ0EB1E102K		B 36/117.8
C249	4030017420	S.CER ECJ0EC1H470J		B 48.1/109.1
C250	4030017380	S.CER ECJ0EC1H050B		B 103.7/58.7
C251	4030017580	S.CER ECJ0EC1H060C	[USA-01]	B 102.6/55.9
	4030017580	S.CER ECJ0EC1H060C	[EXP-01]	
	4030017600	S.CER ECJ0EC1H080C	[USA-02]	
	4030017600	S.CER ECJ0EC1H080C	[EXP-02]	
	4030017580	S.CER ECJ0EC1H060C	[EUR-01]	
C252	4030017460	S.CER ECJ0EB1E102K		B 100.5/50
C253	4030017380	S.CER ECJ0EC1H050B		B 48/116.2
C254	4030017460	S.CER ECJ0EB1E102K		B 103.7/53.4
C255	4030016930	S.CER ECJ0EB1A104K		T 42.1/50.6
C256	4030017640	S.CER ECJ0EC1H150J		T 43.1/55
C257	4030016790	S.CER ECJ0EB1C103K		T 34.5/58.8
C258	4030017580	S.CER ECJ0EC1H060C	[USA-01]	B 59.6/117.8
	4030017580	S.CER ECJ0EC1H060C	[EXP-01]	
	4030017620	S.CER ECJ0EC1H100C	[USA-02]	
	4030017620	S.CER ECJ0EC1H100C	[EXP-02]	
	4030017580	S.CER ECJ0EC1H060C	[EUR-01]	
C259	4030017580	S.CER ECJ0EC1H060C		T 48.5/46.4
C260	4030017460	S.CER ECJ0EB1E102K		B 46.5/105.4
C262	4030016930	S.CER ECJ0EB1A104K		T 69.2/57.5
C263	4030017420	S.CER ECJ0EC1H470J		B 60.5/126.1
C264	4030017460	S.CER ECJ0EB1E102K		B 101.9/50
C265	4030017460	S.CER ECJ0EB1E102K		B 43.5/120.7
C266	4030018900	S.CER ECJ0EB0J474K		T 43.9/45.6
C267	4030017630	S.CER ECJ0EC1H120J	[USA-01]	B 59.6/119.3
	4030017630	S.CER ECJ0EC1H120J	[EXP-01]	
	4030017390	S.CER ECJ0EC1H180J	[USA-02]	
	4030017390	S.CER ECJ0EC1H180J	[EXP-02]	
	4030017630	S.CER ECJ0EC1H120J	[EUR-01]	
C268	4030017420	S.CER ECJ0EC1H470J		B 62.3/126.1
C269	4550006780	S.TAN TEESVB2 0J 476M8R		T 71.8/60.8
C270	4030016930	S.CER ECJ0EB1A104K		T 40.5/49.7
C271	4030017350	S.CER ECJ0EC1H020B		B 68.1/137.9
C272	4030017630	S.CER ECJ0EC1H120J		T 47.3/60.1
C274	4030017460	S.CER ECJ0EB1E102K		B 44.4/120.7

[MAIN UNIT]

REF NO.	ORDER NO.	DESCRIPTION	M.	H/V LOCATION
C275	4030017620	S.CER ECJ0EC1H100C	[USA-01]	B 48/124.4
	4030017620	S.CER ECJ0EC1H100C	[EXP-01]	
	4030017580	S.CER ECJ0EC1H060C	[USA-02]	
	4030017580	S.CER ECJ0EC1H060C	[EXP-02]	
	4030017620	S.CER ECJ0EC1H100C	[EUR-01]	
C276	4030017530	S.CER ECJ0EC1H0R5B	[USA-01]	B 67.2/137.9
	4030017530	S.CER ECJ0EC1H0R5B	[EXP-01]	
	4030017530	S.CER ECJ0EC1H0R5B	[EUR-01]	
C277	4030016790	S.CER ECJ0EB1C103K		T 48.6/36.7
C279	4030017580	S.CER ECJ0EC1H060C	[USA-01]	B 59.6/120.9
	4030017580	S.CER ECJ0EC1H060C	[EXP-01]	
	4030017620	S.CER ECJ0EC1H100C	[USA-02]	
	4030017620	S.CER ECJ0EC1H100C	[EXP-02]	
	4030017580	S.CER ECJ0EC1H060C	[EUR-01]	
C280	4030017460	S.CER ECJ0EB1E102K		B 98.9/66.3
C281	4030017460	S.CER ECJ0EB1E102K		B 100/62
C282	4030017620	S.CER ECJ0EC1H100C	[USA-01]	B 61.4/122.2
	4030017620	S.CER ECJ0EC1H100C	[EXP-01]	
	4030017580	S.CER ECJ0EC1H060C	[USA-02]	
	4030017580	S.CER ECJ0EC1H060C	[EXP-02]	
	4030017620	S.CER ECJ0EC1H100C	[EUR-01]	
C283	4030017620	S.CER ECJ0EC1H100C		B 103.7/65.9
C285	4030017620	S.CER ECJ0EC1H100C	[USA-01]	B 66.1/137.9
	4030017620	S.CER ECJ0EC1H100C	[EXP-01]	
	4030017580	S.CER ECJ0EC1H060C	[USA-02]	
	4030017580	S.CER ECJ0EC1H060C	[EXP-02]	
	4030017620	S.CER ECJ0EC1H100C	[EUR-01]	
C286	4030017530	S.CER ECJ0EC1H0R5B		B 64.5/139.2
C287	4030017350	S.CER ECJ0EC1H020B	[USA-01]	B 61.8/134.7
	4030017350	S.CER ECJ0EC1H020B	[EXP-01]	
	4030017550	S.CER ECJ0EC1H1R5B	[USA-02]	
	4030017550	S.CER ECJ0EC1H1R5B	[EXP-02]	
	4030017350	S.CER ECJ0EC1H020B	[EUR-01]	
C291	4030017340	S.CER ECJ0EC1H010B	[USA-01]	B 102.4/66.6
	4030017340	S.CER ECJ0EC1H010B	[EXP-01]	
	4030017340	S.CER ECJ0EC1H010B	[EUR-01]	
C292	4030017460	S.CER ECJ0EB1E102K		B 65/136.3
C293	4030017620	S.CER ECJ0EC1H100C	[USA-01]	B 62.9/137.9
	4030017620	S.CER ECJ0EC1H100C	[EXP-01]	
	4030017580	S.CER ECJ0EC1H060C	[USA-02]	
	4030017580	S.CER ECJ0EC1H060C	[EXP-02]	
	4030017620	S.CER ECJ0EC1H100C	[EUR-01]	
C294	4030017530	S.CER ECJ0EC1H0R5B		B 58.3/138.5
C295	4030017460	S.CER ECJ0EB1E102K		B 65/134.7
C296	4030017620	S.CER ECJ0EC1H100C	[USA-01]	B 56.1/138
	4030017620	S.CER ECJ0EC1H100C	[EXP-01]	
	4030017580	S.CER ECJ0EC1H060C	[USA-02]	
	4030017580	S.CER ECJ0EC1H060C	[EXP-02]	
	4030017620	S.CER ECJ0EC1H100C	[EUR-01]	
C298	4030017460	S.CER ECJ0EB1E102K		B 136.2/82.9
C299	4030017460	S.CER ECJ0EB1E102K		B 50.4/133.8
C300	4030017460	S.CER ECJ0EB1E102K		B 54.1/133.9
C301	4030016790	S.CER ECJ0EB1C103K		B 51.4/133.8
C302	4030017460	S.CER ECJ0EB1E102K		B 52/138.5
C303	4030017370	S.CER ECJ0EC1H3R5B		B 131.4/82.3
C304	4030017420	S.CER ECJ0EC1H470J		B 136.2/81.9
C305	4030017420	S.CER ECJ0EC1H470J		B 46.4/133.8
C306	4030017460	S.CER ECJ0EB1E102K		B 47.4/133.8
C307	4030017460	S.CER ECJ0EB1E102K		B 45.4/138.3
C309	4030017420	S.CER ECJ0EC1H470J		B 136.8/84.5
C310	4030017380	S.CER ECJ0EC1H050B	[USA-01]	B 134.9/85.9
	4030017380	S.CER ECJ0EC1H050B	[EXP-01]	
	4030017370	S.CER ECJ0EC1H3R5B	[USA-02]	
	4030017370	S.CER ECJ0EC1H3R5B	[EXP-02]	
	4030017380	S.CER ECJ0EC1H050B	[EUR-01]	
C311	4030016930	S.CER ECJ0EB1A104K		B 45.4/140.4
C312	4030017420	S.CER ECJ0EC1H470J		B 50.4/140.4
C313	4030016930	S.CER ECJ0EB1A104K		B 46.4/140.4
C314	4030017460	S.CER ECJ0EB1E102K		B 49.4/140.4
C315	4030017730	S.CER ECJ0EB1E471K		B 137.8/84.5
C316	4030017570	S.CER ECJ0EC1H040B		B 130.4/80.9
C321	4030017420	S.CER ECJ0EC1H470J		T 66/57.5
C322	4030017420	S.CER ECJ0EC1H470J		T 67.6/54.3
C323	4030017620	S.CER ECJ0EC1H100C		B 44.4/137.7
C324	4030017530	S.CER ECJ0EC1H0R5B	[USA-01]	B 134.9/88.3
	4030017530	S.CER ECJ0EC1H0R5B	[EXP-01]	
	4030017520	S.CER ECJ0EC1H0		



[MAIN UNIT]

REF NO.	ORDER NO.	DESCRIPTION	M.	H/V LOCATION
C340	4030016930	S.CER ECJ0EB1A104K	T	54/20.3
C341	4030017420	S.CER ECJ0EC1H470J	T	143.1/123.3
C342	4030017730	S.CER ECJ0EB1E471K	T	138.8/108
C345	4030017460	S.CER ECJ0EB1E102K	B	30.6/135.9
C346	4030017420	S.CER ECJ0EC1H470J	T	63.1/57.2
C347	4030017460	S.CER ECJ0EB1E102K	T	143.1/124.2
C348	4030017420	S.CER ECJ0EC1H470J	T	63.8/55.2
C349	4030017580	S.CER ECJ0EC1H060C	B	143.5/95.2
C350	4030017420	S.CER ECJ0EC1H470J	T	138.7/112.3
C351	4030017460	S.CER ECJ0EB1E102K	T	138.7/113.2
C352	4030017410	S.CER ECJ0EC1H240J [USA-01]	B	31.6/137.9
	4030017410	S.CER ECJ0EC1H240J [EXP-01]		
	4030017390	S.CER ECJ0EC1H180J [USA-02]		
	4030017390	S.CER ECJ0EC1H180J [EXP-02]		
	4030017410	S.CER ECJ0EC1H240J [EUR-01]		
C353	4030017460	S.CER ECJ0EB1E102K	T	140.4/118.8
C354	4030017420	S.CER ECJ0EC1H470J	T	106.6/115.9
C355	4030017580	S.CER ECJ0EC1H060C [USA-01]	B	37.5/136.8
	4030017580	S.CER ECJ0EC1H060C [EXP-01]		
	4030017590	S.CER ECJ0EC1H070C [USA-02]		
	4030017590	S.CER ECJ0EC1H070C [EXP-02]		
	4030017580	S.CER ECJ0EC1H060C [EUR-01]		
C357	4030017630	S.CER ECJ0EC1H120J	B	39.3/140
C358	4030016790	S.CER ECJ0EB1C103K	T	137.5/128.2
C359	4510009550	S.ELE EEEFK1C100R	T	107.2/86.5
C360	4030017460	S.CER ECJ0EB1E102K	T	106.6/116.8
C361	4030011030	S.CER GRM31M4C2H1R5CY21L (GRM42-6 CK) [EUR-01] only	B	100.2/115.8
C362	4030017510	S.CER ECJ0EC1H680J	B	39.7/144.6
C364	4030011020	S.CER GRM31M4C2H1R0CY21L (GRM42-6 CK)	B	89.8/119.8
C365	4030017730	S.CER ECJ0EB1E471K	T	106.6/117.7
C366	4030016970	S.CER ECJ0EB1C223K	T	142.4/126.6
C367	4510009810	S.ELE EEEFK1E220R	T	107.3/95.1
C368	4030006860	S.CER C1608 JB 1H 102K-T	T	89.1/142
C369	4030017460	S.CER ECJ0EB1E102K	B	33.4/134
C370	4030011060	S.CER GRM31M2C2H4R0CY21L (GRM42-6 CH) [USA-01]	B	100.2/123.1
	4030011070	S.CER GRM31M2C2H5R0CY21L (GRM42-6 CH) [EXP-01]		
	4030011070	S.CER GRM31M2C2H5R0CY21L (GRM42-6 CH) [EUR-01]		
C371	4030006980	S.CER C1608 CH 1H 070D-T	T	35.5/142.5
C372	4030011100	S.CER GRM31M2C2H8R0DV01L (GRM42-6 CH)	B	100.2/121
C373	4030017780	S.CER ECJ0EB1E472K	T	136.7/123.8
C374	4030017420	S.CER ECJ0EC1H470J	B	85.2/129.8
C375	4030017460	S.CER ECJ0EB1E102K	T	113.1/95.2
C376	4030017350	S.CER ECJ0EC1H020B	B	86/138.8
C377	4030017420	S.CER ECJ0EC1H470J	B	84.2/119.4
C378	4030017420	S.CER ECJ0EC1H470J	T	112.2/95.2
C381	4030017400	S.CER ECJ0EC1H220J	T	111.3/95.2
C383	4030017460	S.CER ECJ0EB1E102K	T	114/78.2
C385	4030017460	S.CER ECJ0EB1E102K	B	22.8/142.4
C386	4030017460	S.CER ECJ0EB1E102K	T	139.2/119.6
C387	4030017600	S.CER ECJ0EC1H080C	B	89.7/137.9
C388	4510009550	S.ELE EEEFK1C100R	T	126.4/77.2
C389	4030017200	S.CER GRM31BR32J102KY01L (GHM1030 F)	B	96.8/130.4
C390	4030011070	S.CER GRM31M2C2H5R0CY21L (GRM42-6 CH)	B	87.6/133.2
C391	4030017460	S.CER ECJ0EB1E102K	T	122.2/76
C392	4030017520	S.CER ECJ0EC1H0R3B	B	95.4/134.3
C393	4030011050	S.CER GRM31M3C2H3R0CY21L (GRM42-6 CJ)	B	98.4/126.8
C394	4550006250	S.TAN TEESVA 1A 106M8R	B	26.3/15.3
C395	4030011050	S.CER GRM31M3C2H3R0CY21L (GRM42-6 CJ)	B	100.5/126.9
C396	4510009550	S.ELE EEEFK1C100R	T	97/77.8
C397	4030017460	S.CER ECJ0EB1E102K	T	137.4/118.5
C398	4550006250	S.TAN TEESVA 1A 106M8R	B	31.7/15.5
C399	4030017460	S.CER ECJ0EB1E102K	T	100/76.1
C400	4030017460	S.CER ECJ0EB1E102K	B	86.2/129.8
C401	4030011080	S.CER GRM31M2C2H6R0DV01L (GRM42-6 CH)	B	103.2/130.9
C402	4030016930	S.CER ECJ0EB1A104K	T	47.2/71.6
C403	4030011050	S.CER GRM31M3C2H3R0CY21L (GRM42-6 CJ)	B	106.2/130.9
C404	4030017460	S.CER ECJ0EB1E102K	T	140.7/129.2
C405	4030017420	S.CER ECJ0EC1H470J	B	56.7/55.3
C406	4030016790	S.CER ECJ0EB1C103K	T	103.5/76.2
C407	4030011030	S.CER GRM31M4C2H1R5CY21L (GRM42-6 CK)	B	102.6/137.2
C408	4030017460	S.CER ECJ0EB1E102K	B	98.1/138.5
C409	4030011050	S.CER GRM31M3C2H3R0CY21L (GRM42-6 CJ)	B	110.9/136
C410	4030011050	S.CER GRM31M3C2H3R0CY21L (GRM42-6 CJ) [USA-01]	B	113/134
	4030011050	S.CER GRM31M3C2H3R0CY21L (GRM42-6 CJ) [EXP-01]		
	4030011060	S.CER GRM31M2C2H4R0CY21L (GRM42-6 CH) [USA-02]		
	4030011060	S.CER GRM31M2C2H4R0CY21L (GRM42-6 CH) [EXP-02]		
	4030011050	S.CER GRM31M3C2H3R0CY21L (GRM42-6 CJ) [EUR-01]		
C411	4550007650	S.TAN F931V105MAABMA	T	37.5/68.6
C412	4030017460	S.CER ECJ0EB1E102K	T	112.6/78.5
C413	4030016930	S.CER ECJ0EB1A104K	T	38.5/71.9
C414	4030017420	S.CER ECJ0EC1H470J	B	29.7/135.9
C415	4550007650	S.TAN F931V105MAABMA	T	37.5/63.4
C416	4550006250	S.TAN TEESVA 1A 106M8R	T	107.8/81.5
C417	4030016930	S.CER ECJ0EB1A104K	T	15/125.7
C418	4550007650	S.TAN F931V105MAABMA	T	39.4/73.9

[MAIN UNIT]

REF NO.	ORDER NO.	DESCRIPTION	M.	H/V LOCATION
C419	4030011050	S.CER GRM31M3C2H3R0CY21L (GRM42-6 CJ) [USA-01]	B	115.7/134
	4030011050	S.CER GRM31M3C2H3R0CY21L (GRM42-6 CJ) [EXP-01]		
	4030011050	S.CER GRM31M3C2H3R0CY21L (GRM42-6 CJ) [USA-02]		
	4030011050	S.CER GRM31M3C2H3R0CY21L (GRM42-6 CJ) [EXP-02]		
	4030011080	S.CER GRM31M2C2H6R0DV01L (GRM42-6 CH) [EUR-01]		
C420	4030016930	S.CER ECJ0EB1A104K	B	27.4/18.5
C422	4030006860	S.CER C1608 JB 1H 102K-T	B	119.5/139.5
C423	4030017460	S.CER ECJ0EB1E102K	B	119.4/145.9
C424	4030016930	S.CER ECJ0EB1A104K	T	14.1/125.7
C426	4030009530	S.CER C1608 CH 1H 030B-T [USA-01]	B	120.8/139.5
	4030009530	S.CER C1608 CH 1H 030B-T [EXP-01]		
	4030009530	S.CER C1608 CH 1H 030B-T [USA-02]		
	4030009530	S.CER C1608 CH 1H 030B-T [EXP-02]		
	4030009540	S.CER C1608 CH 1H 1R5B-T [EUR-01]		
C431	4030018860	S.CER ECJ0EB0J105K	B	33.3/13.6
C432	4030016930	S.CER ECJ0EB1A104K	T	10.8/120.6
C433	4030006860	S.CER C1608 JB 1H 102K-T	B	139.5/137.7
C434	4030017460	S.CER ECJ0EB1E102K	B	140.5/131
C435	4030017460	S.CER ECJ0EB1E102K	T	54.8/29.8
C436	4030011050	S.CER GRM31M3C2H3R0CY21L (GRM42-6 CJ) [USA-01]	B	144.8/138.6
	4030011050	S.CER GRM31M3C2H3R0CY21L (GRM42-6 CJ) [EXP-01]		
	4030011050	S.CER GRM31M3C2H3R0CY21L (GRM42-6 CJ) [USA-02]		
	4030011050	S.CER GRM31M3C2H3R0CY21L (GRM42-6 CJ) [EXP-02]		
	4030011040	S.CER GRM31M4C2H2R0CY21L (GRM42-6 CK) [EUR-01]		
C437	4030016930	S.CER ECJ0EB1A104K	B	34.4/12
C438	4030016790	S.CER ECJ0EB1C103K	T	112.8/88.2
C439	4510009810	S.ELE EEEFK1E220R	T	128.4/89.8
C440	4030018900	S.CER ECJ0EB0J474K	T	7.9/129.6
C441	4030017440	S.CER ECJ0EC1H221J	T	12/126.2
C442	4510008780	S.ELE EEE1EA471P	B	9.6/119.8
C443	4030017460	S.CER ECJ0EB1E102K	T	111.9/88.2
C444	4030011070	S.CER GRM31M2C2H5R0CY21L (GRM42-6 CH) [USA-01]	B	147/148.9
	4030011070	S.CER GRM31M2C2H5R0CY21L (GRM42-6 CH) [EXP-01]		
	4030011070	S.CER GRM31M2C2H5R0CY21L (GRM42-6 CH) [USA-02]		
	4030011070	S.CER GRM31M2C2H5R0CY21L (GRM42-6 CH) [EXP-02]		
	4030011060	S.CER GRM31M2C2H4R0CY21L (GRM42-6 CH) [EUR-01]		
C446	4030017460	S.CER ECJ0EB1E102K	T	6.6/130.1
C448	4030017460	S.CER ECJ0EB1E102K	T	128.8/102.4
C449	4510008870	S.ELE EEE1AA471UP	B	8.9/139.2
C450	4030016930	S.CER ECJ0EB1A104K	T	7/125.3
C451	4030018860	S.CER ECJ0EB0J105K	T	8.6/125.3
C452	4030018860	S.CER ECJ0EB0J105K	T	72/98.2
C453	4030017460	S.CER ECJ0EB1E102K	T	130.8/103.6
C454	4030017430	S.CER ECJ0EC1H101J	B	46.3/56.9
C458	4030017460	S.CER ECJ0EB1E102K	T	114.8/95.7
C459	4030017460	S.CER ECJ0EB1E102K	T	116.3/119.1
C460	4030017460	S.CER ECJ0EB1E102K	B	9.6/147.3
C461	4030017420	S.CER ECJ0EC1H470J	T	114.8/94.8
C462	4030017420	S.CER ECJ0EC1H470J	T	115.3/119.1
C463	4030017420	S.CER ECJ0EC1H470J	B	9.6/146.4
C464	4510009680	S.ELE EEEFK1E471P	B	144.4/121.1
C465	4550006250	S.TAN TEESVA 1A 106M8R	T	102.7/92
C466	4030017420	S.CER ECJ0EC1H470J	T	99.9/88
C467	4030016930	S.CER ECJ0EB1A104K	T	62.3/58.5
C468	4030016930	S.CER ECJ0EB1A104K	T	61.7/56.9
C470	4030018860	S.CER ECJ0EB0J105K	T	7.4/122.3
C471	4030016790	S.CER ECJ0EB1C103K	T	7/124.4
C472	4030018860	S.CER ECJ0EB0J105K	T	10.9/117.7
C473	4030018860	S.CER ECJ0EB0J105K	T	5/118.9
C474	4030017780	S.CER ECJ0EB1E472K	T	115.3/17.6
C475	4510008120	S.ELE 16 CE 100 BS	T	125.1/12.1
C476	4510008120	S.ELE 16 CE 100 BS	T	125.1/19.3
C477	4030017780	S.CER ECJ0EB1E472K	T	119/12.3
C478	4030017780	S.CER ECJ0EB1E472K	T	115.3/12.2
C479	4510008120	S.ELE 16 CE 100 BS	T	104.8/14.3
C481	4030017460	S.CER ECJ0EB1E102K	B	63.2/122.2
C491	4030016930	S.CER ECJ0EB1A104K	T	60.4/60.1
C492	4030016930	S.CER ECJ0EB1A104K	B	13.5/32.6
C493	4510008870	S.ELE EEE1AA471UP	B	66.3/45.3
C494	4030016930	S.CER ECJ0EB1A104K	T	117.2/92.6
C495	4030016930	S.CER ECJ0EB1A104K	T	117.2/90.7
C496	4030016930	S.CER ECJ0EB1A104K	T	122.4/92.2
C497	4030016930	S.CER ECJ0EB1A104K	T	109.7/82
C498	4030016930	S.CER ECJ0EB1A104K	T	11.4/43.2
C501	4030017420	S.CER ECJ0EC1H470J	T	12.2/31.2
C502	4030017420	S.CER ECJ0EC1H470J	T	29.5/2.8
C503	4030017420	S.CER ECJ0EC1H470J	T	48/99.4
C506	4030016930	S.CER ECJ0EB1A104K	B	26.3/43.3
C507	4030016930	S.CER ECJ0EB1A104K	B	32.9/31
C508	4030016930	S.CER ECJ0EB1A104K	B	40.1/42.7
C509	4030016930	S.CER ECJ0EB1A104K	B	26.2/39
C510	4030016930	S.CER ECJ0EB1A104K	B	26.6/33
C511	4030016930	S.CER ECJ0EB1A104K	B	40.1/34.2
C512	4030017420	S.CER ECJ0EC1H470J	T	92/14.7
C513	4550006250	S.TAN TEESVA 1A 106M8R	B	8.4/59.8
C514	4030016930	S.CER ECJ0EB1A104K	B	11.7/53.5
C515	4030016930	S.CER ECJ0EB1A104K	B	15.5/54.4
C516	4030016930	S.CER ECJ0EB1A104K	T	65.1/69.6
C517	4030016930	S.CER ECJ0EB1A104K	B	15.6/63.1

M.=Mounted side (T: Mounted on the Top side, B: Mounted on the Bottom side) S.=Surface mount

[MAIN UNIT]

REF NO.	ORDER NO.	DESCRIPTION	M.	H/V LOCATION
C518	4030016930	S.CER ECJ0EB1A104K	B	12.4/62.4
C519	4030017460	S.CER ECJ0EB1E102K	B	15.6/59.9
C521	4030016930	S.CER ECJ0EB1A104K	B	18.1/53.6
C522	4030016930	S.CER ECJ0EB1A104K	T	51.2/31.8
C523	4030016930	S.CER ECJ0EB1A104K	T	51.2/33
C524	4030018910	S.CER C1608 JB 0J 475K-T	T	9.5/56
C525	4030018910	S.CER C1608 JB 0J 475K-T	B	25.8/58.3
C526	4030017730	S.CER ECJ0EB1E471K	B	29.8/57.9
C527	4030016790	S.CER ECJ0EB1C103K	B	26.1/50.3
C528	4030017670	S.CER ECJ0EC1H390J	B	37.4/120.7
C529	4030017630	S.CER ECJ0EC1H120J	B	38.3/112.2
C530	4030017420	S.CER ECJ0EC1H470J	T	60.4/62.3
C531	4030017670	S.CER ECJ0EC1H390J	B	93.3/62
C532	4030017670	S.CER ECJ0EC1H390J	B	93.6/52.9
C533	4510008120	S.ELE 16 CE 100 BS	T	125.1/26.4
C534	4030016790	S.CER ECJ0EB1C103K	T	118.5/26.7
C535	4030016790	S.CER ECJ0EB1C103K	B	67.4/101.6
C536	4030016790	S.CER ECJ0EB1C103K	B	65.7/98.3
C538	4030006860	S.CER C1608 JB 1H 102K-T	T	36.2/145.1
C539	4030017790	S.CER ECJ0EB1E682K	T	22.8/57
C540	4030017730	S.CER ECJ0EB1E471K	T	21.2/56.6
C541	4030016930	S.CER ECJ0EB1A104K	T	22.8/55.4
C542	4030017440	S.CER ECJ0EC1H221J	T	27.1/55
C543	4030016930	S.CER ECJ0EB1A104K	T	56.5/68.9
C544	4030017460	S.CER ECJ0EB1E102K	T	62.4/72.9
C545	4030011060	S.CER GRM31M2C2H4R0CY21L (GRM42-6 CH) [USA-01]	T	97.6/106.8
	4030011060	S.CER GRM31M2C2H4R0CY21L (GRM42-6 CH) [EXP-01]		
	4030011050	S.CER GRM31M3C2H3R0CY21L (GRM42-6 CJ) [USA-02]		
	4030011050	S.CER GRM31M3C2H3R0CY21L (GRM42-6 CJ) [EXP-02]		
	4030011060	S.CER GRM31M2C2H4R0CY21L (GRM42-6 CH) [EUR-01]		
C546	4030018910	S.CER C1608 JB 0J 475K-T	B	40.4/56.7
C547	4030017760	S.CER ECJ0EB1H222K	T	53.7/72.1
C548	4030016930	S.CER ECJ0EB1A104K	T	14.1/120.6
C549	4030017420	S.CER ECJ0EC1H470J	T	23.1/86.8
C550	4030017420	S.CER ECJ0EC1H470J	T	70.1/82.6
C551	4030017330	S.CER ECJ0EF1C104Z	T	114.2/28.9
C552	4030016790	S.CER ECJ0EB1C103K	B	121.9/48.8
C553	4030016930	S.CER ECJ0EB1A104K	B	30.8/19.4
C555	4030016930	S.CER ECJ0EB1A104K	B	69.8/75.5
C556	4030016930	S.CER ECJ0EB1A104K	T	105.2/28.6
C557	4030016930	S.CER ECJ0EB1A104K	T	97/28.6
C558	4550006250	S.TAN TEESVA 1A 106M8R	T	95.1/27.9
C559	4550007080	S.TAN TEESVA 1C 106M8R	T	45.9/75.5
C562	4030017420	S.CER ECJ0EC1H470J	T	38.5/76.1
C563	4030016930	S.CER ECJ0EB1A104K	B	26.5/122.3
C564	4030017570	S.CER ECJ0EC1H040B	B	68.3/131.3
C565	4030017340	S.CER ECJ0EC1H010B	B	47.9/113.5
C566	4030018860	S.CER ECJ0EB0J105K	B	39/72.7
C571	4030017580	S.CER ECJ0EC1H060C	T	64.6/99.1
C572	4030017580	S.CER ECJ0EC1H060C	T	65.6/99.1
C573	4030017580	S.CER ECJ0EC1H060C	T	65.3/97.4
C574	4030017580	S.CER ECJ0EC1H060C	B	64/134.7
C575	4030017420	S.CER ECJ0EC1H470J	B	62.9/132.4
C576	4030017460	S.CER ECJ0EB1E102K	T	67.1/106.5
C577	4030017460	S.CER ECJ0EB1E102K	T	67.1/104.9
C578	4030017200	S.CER GRM31BR32J102KY01L (GHM1030 R)	T	92/126
C579	4550006250	S.TAN TEESVA 1A 106M8R	B	94.7/50.6
C580	4030017420	S.CER ECJ0EC1H470J	T	100.7/73.5
C581	4030018910	S.CER C1608 JB 0J 475K-T	B	46.3/60.9
C582	4030018910	S.CER C1608 JB 0J 475K-T	T	69.7/98.2
C583	4030016930	S.CER ECJ0EB1A104K	B	46.3/58.6
C584	4030016790	S.CER ECJ0EB1C103K	B	54.9/55.3
C585	4030016930	S.CER ECJ0EB1A104K	B	54.9/58.6
C586	4030017730	S.CER ECJ0EB1E471K	B	54.9/56.9
C587	4030016790	S.CER ECJ0EB1C103K	B	52.3/59.8
C588	4030018910	S.CER C1608 JB 0J 475K-T	T	70.9/98.2
C601	4030011060	S.CER GRM31M2C2H4R0CY21L (GRM42-6 CH) [USA-01]	T	97.6/111.3
	4030011060	S.CER GRM31M2C2H4R0CY21L (GRM42-6 CH) [EXP-01]		
	4030011060	S.CER GRM31M2C2H4R0CY21L (GRM42-6 CH) [USA-02]		
	4030011060	S.CER GRM31M2C2H4R0CY21L (GRM42-6 CH) [EXP-02]		
	4030011070	S.CER GRM31M2C2H5R0CY21L (GRM42-6 CH) [EUR-01]		
C610	4030018080	S.CER ECJ0EB1H182K	T	63.3/69.6
C612	4030017460	S.CER ECJ0EB1E102K	B	55.7/29.9
C614	4030017730	S.CER ECJ0EB1E471K	B	29/13.2
C615	4030017650	S.CER ECJ0EC1H270J	B	63.2/117.5
C616	4030017460	S.CER ECJ0EB1E102K	T	93.8/64.6
C617	4030017420	S.CER ECJ0EC1H470J	T	60/64.8
C618	4030017420	S.CER ECJ0EC1H470J	T	64.9/53.3
C619	4030017420	S.CER ECJ0EC1H470J	T	74.2/107.7
C620	4030017420	S.CER ECJ0EC1H470J	T	73.7/96.8
C621	4030017420	S.CER ECJ0EC1H470J	T	31.5/2.8
C622	4030018910	S.CER C1608 JB 0J 475K-T	T	64.3/73.2
C623	4030017330	S.CER ECJ0EF1C104Z	B	126.8/16
C624	4030017330	S.CER ECJ0EF1C104Z	B	126.3/20.3
C625	4030017460	S.CER ECJ0EB1E102K	B	126.8/17.2
C626	4510009810	S.ELE EEEFK1E220R	B	129.4/23
C630	4030017420	S.CER ECJ0EC1H470J [EUR-01] only	T	106.4/106.8
C631	4030017580	S.CER ECJ0EC1H060C [EUR-01] only	T	113.5/108.3
C637	4510009680	S.ELE EEEFK1E471P	B	84.9/23.4
J1	6510026770	S.CON AXK540147YG	T	23.1/63.7
J2	6510023092	S.CON 20FLT-SM2-TB(LF)(SN)(M)	T	14.8/15.6

[MAIN UNIT]

REF NO.	ORDER NO.	DESCRIPTION	M.	H/V LOCATION
J4	6510023511	S.CON 28FLT-SM2-TB(LF)(SN)	T	70.8/102
J5	6510023110	CON 3008L-8P8C <KIN>		
J6	6450000140	CON HSJ0807-01-010		
J8	6510023092	S.CON 20FLT-SM2-TB(LF)(SN)(M)	T	59.1/15.6
J9	6510019371	S.CON B3B-ZR-SM4-TF(LF)(SN)	T	94.6/14.3
J10	6510004910	CON NR-DS-E 01		
J11	6510004910	CON NR-DS-E 01		
DS1	5040002961	S.LED SML-A12MT T86J	B	96/1.1
DS2	5040002961	S.LED SML-A12MT T86J	B	126/1.1
DS3	5040003000	S.LED SML-A12UT-T86	B	111/1.1
MF1	2710000870	FAN AFB0512HB-7X22 <USE>HK		
W1	7120000470	JUM ERDS2T0		
W2	7120000470	JUM ERDS2T0		
W4	8900017520	CAB OPC-1783		
EP1	6910015370	S.BEA ACZ1005Y-102-T	B	129.1/48.4
EP2	6910015370	S.BEA ACZ1005Y-102-T	B	117.2/48.4
EP3	6910015370	S.BEA ACZ1005Y-102-T	B	32.4/81.6
EP4	6910016330	S.BEA MMZ1005S 601CT-S	B	30.4/60.5
EP5	6910015370	S.BEA ACZ1005Y-102-T	B	39/74.5
EP6	6910015370	S.BEA ACZ1005Y-102-T	B	37.8/109
EP7	6910016330	S.BEA MMZ1005S 601CT-S	B	40.7/36.7
EP8	6910015370	S.BEA ACZ1005Y-102-T	B	94.5/48.8
EP9	6910016330	S.BEA MMZ1005S 601CT-S	T	48.8/39.3

[CONNECT UNIT]

REF NO.	ORDER NO.	DESCRIPTION	M.	H/V LOCATION
C601	4030017420	S.CER ECJ0EC1H470J	T	13.8/12.4
C602	4030017400	S.CER ECJ0EC1H220J	T	12.2/12.4
C603	4030017420	S.CER ECJ0EC1H470J	T	16.5/12.4
C604	4030017400	S.CER ECJ0EC1H220J	T	15/14.2
C605	4030017420	S.CER ECJ0EC1H470J	T	17.8/13.9
C606	4030017420	S.CER ECJ0EC1H470J	T	19.4/12.4
C607	4030017420	S.CER ECJ0EC1H470J	T	20.5/13.9
C608	4030017420	S.CER ECJ0EC1H470J	T	22.6/12.4
C609	4030017420	S.CER ECJ0EC1H470J	T	25.5/12.4
C610	4030017420	S.CER ECJ0EC1H470J	T	29.7/12.8
C611	4030017420	S.CER ECJ0EC1H470J	T	31/14.1
C612	4030017420	S.CER ECJ0EC1H470J	T	32.4/12.8
C613	4030017420	S.CER ECJ0EC1H470J	T	33.5/14.1
C614	4030017420	S.CER ECJ0EC1H470J	T	35.2/14.1
C615	4030017420	S.CER ECJ0EC1H470J	T	35.7/12.8
C616	4030017420	S.CER ECJ0EC1H470J	B	35.2/15.6
C617	4030017420	S.CER ECJ0EC1H470J	T	37.5/13.5
C618	4030017420	S.CER ECJ0EC1H470J	T	39.3/12.2
C619	4030017420	S.CER ECJ0EC1H470J	T	39.9/13.4
C620	4030017420	S.CER ECJ0EC1H470J	T	41.3/12.6
C621	4030017420	S.CER ECJ0EC1H470J	T	27.4/13.9
J601	6510026290	S.CON IMSA-9631S-28Y921	B	22.8/16.2
J602	6510023210	CON CD6125SA1J0 <CVI>		
S1	22600003070	S.SWI MINISMDC150F/24-2	B	38.9/18
W601	8900017500	CAB OPC-1852 (P0.5,N28,L90) <TJM>		

M.=Mounted side (T: Mounted on the Top side, B: Mounted on the Bottom side)  
S.=Surface mount

# VOLTAGE DIAGRAM

## MAIN UNIT (1/3)

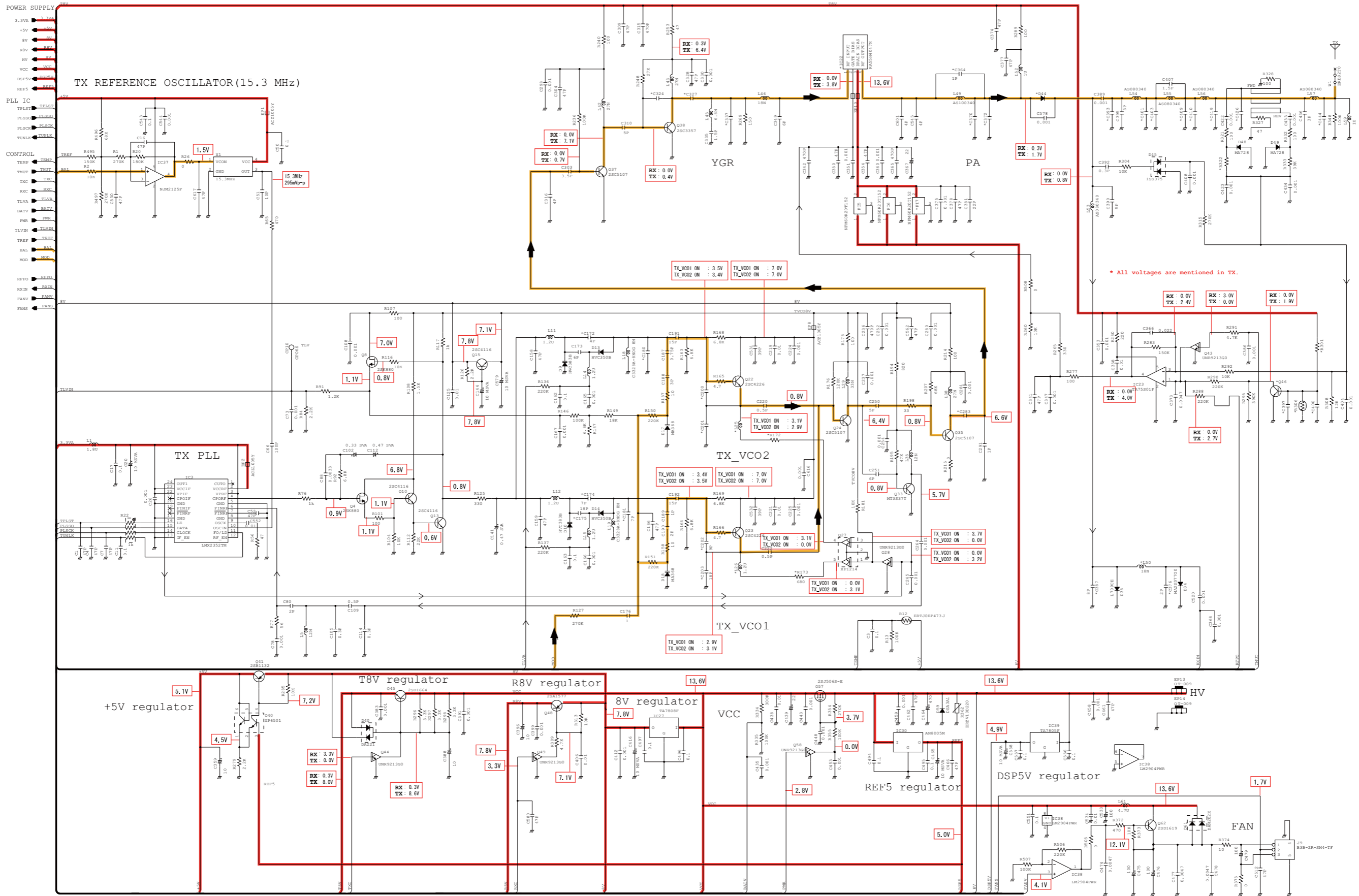

\*; Refer to "PARTS LIST."





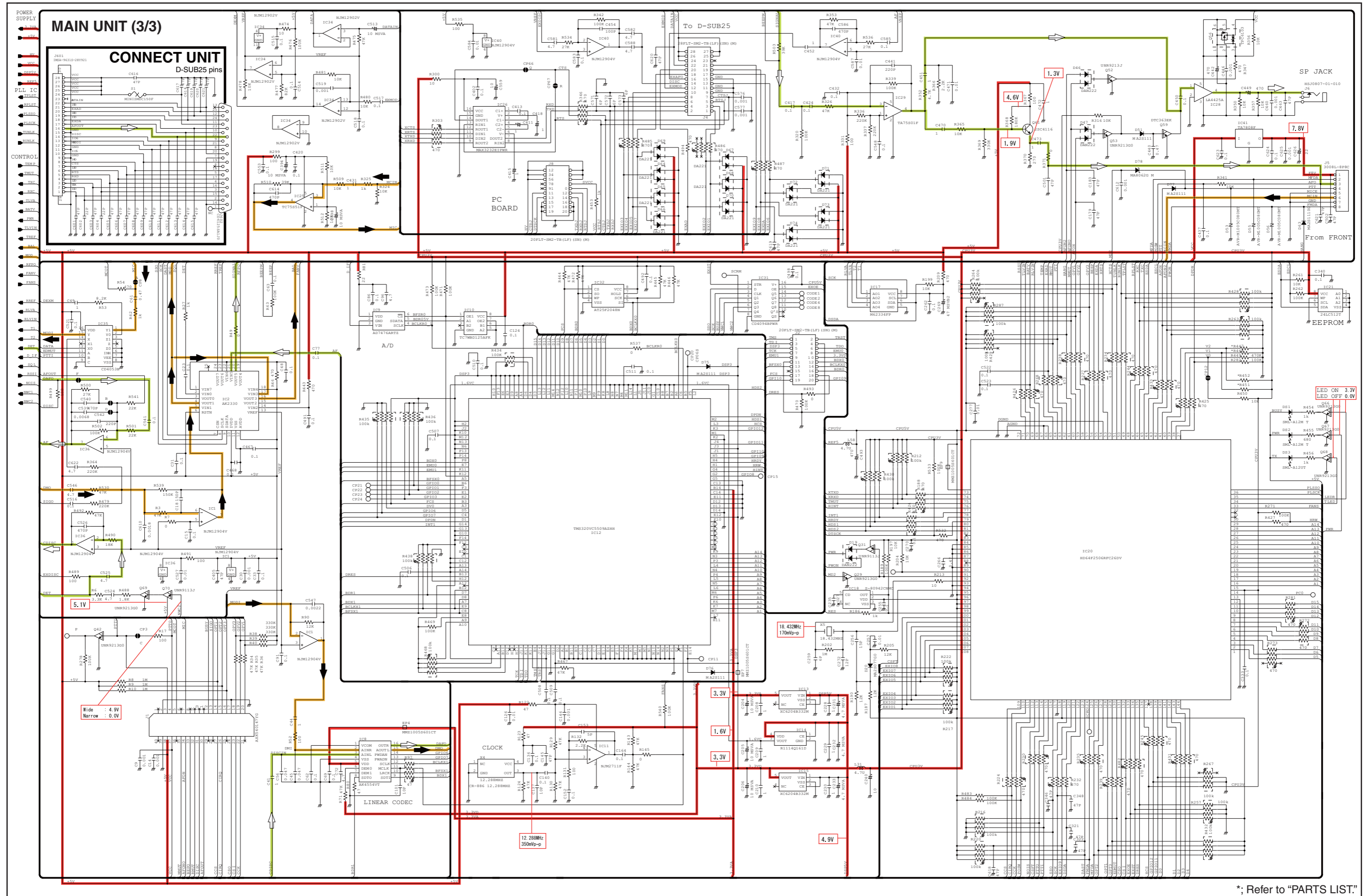

\*; Refer to "PARTS LIST"

Feb. 2009



# SERVICE MANUAL ADDENDUM

---

## UR-FR6000 UR-FR6100

---

### CONTENTS

PARTS LIST .....	1
VOLTAGE DIAGRAM .....	9



# PARTS LIST

## [MAIN UNIT]

REF NO.	ORDER NO.	DESCRIPTION	M.	H/V LOCATION
IC1	1110005330	S.IC NJM12904V-TE1-#ZZZB	T	58.1/71.4
IC2	1110007290	S.IC AK2330P-L	T	58.7/56.1
IC3	1130010100	S.IC LMX2352TMX/NOPB	B	120.2/43.9
IC4	1130010100	S.IC LMX2352TMX/NOPB	B	28/78.8
IC5	1110003491	S.IC TA31136FNG(D,EL)	B	70.4/82.5
IC7	1110007280	S.IC NJM2716F-TE1-#ZZZB	B	56.8/46.4
IC8	1130012910	S.IC AK4554VTP-E2/P	B	36.2/59.9
IC9	1190002080	S.IC AD7476ARTZ-500RL7	B	49.6/46.4
IC10	1130013040	S.IC TC7WBD125AFK(T5L,F)	B	46.6/49.2
IC11	1110006230	S.IC NJM2711F-TE1-#ZZZB	B	53.1/35
IC12	1140013290	S.IC TMS320VC5509AZHH	B	33.3/37.8
IC13	1180002590	S.REG XC6204B332MR	T	80.9/21.3
IC14	1180003270	S.REG R1114Q161D-TR-F	T	84.4/21.4
IC15	1180002590	S.REG XC6204B332MR	T	87.8/21.3
IC17	1190001340	S.IC M62334FP 600C	T	67.3/61.7
IC18	1110005771	S.IC S-80942CNMC-G9CT2G	T	41.2/52.8
IC20	1140014550	S.IC HD64F2506RFC26DV(EMPTY)	T	33.5/37.6
IC21	1140012950	S.IC 24LC512T-1/SM	T	59.1/21.8
IC22	1150002211	IC RA55H4047M-121 [USA-01]		
	1150002211	IC RA55H4047M-121 [EXP-01]		
	1150002221	IC RA55H4452M-121 [USA-02]		
	1150002221	IC RA55H4452M-121 [EXP-02]		
	1150002092	IC RA30H4047M-121 [EUR-01]		
IC23	1110002751	S.IC TA75S01F(TE85R,F)	T	139.3/125.6
IC25	1130008561	S.IC TC7S551F(TE85L,F)	B	29/16.3
IC26	1120003070	S.IC MAX3232EIPWR	T	42.7/70
IC27	1180001251	S.IC TA7808F(TE16L,Q)	T	116.6/84.1
IC28	1110003091	IC LA4425A-E		
IC29	1110002751	S.IC TA75S01F(TE85R,F)	T	12/123.1
IC30	1110003390	S.IC AN8005M-(E1)	T	114.1/91.8
IC31	1130011760	S.IC CD4094BPWR	T	8.1/45.2
IC32	1130013360	S.IC AT25F2048N-10SU-2.7SL383	B	8.9/36.1
IC34	1110005340	S.IC NJM12902V-TE1-#ZZZB	B	12.2/58.2
IC35	1140013200	S.IC CD4093BPWR	B	20.6/58.2
IC36	1110005330	S.IC NJM12904V-TE1-#ZZZB	B	27.8/55.4
IC37	1120002830	S.IC NJM2125F-TE1-#ZZZB	T	56.6/66.7
IC38	1110006380	S.IC LM2904PWR	T	114.1/23.8
IC39	1180001071	S.IC TA7805F(TE16L,Q)	T	101.2/24.3
IC40	1110005330	S.IC NJM12904V-TE1-#ZZZB	B	50.6/57.2
IC41	1180001251	S.IC TA7808F(TE16L,Q)	B	132/16.7
Q1	1590003230	S.TRA UNR9113J-(TX)	B	53.4/79.7
Q2	1530002851	S.TRA 2SC4116-BL(TE85R,F)	B	34.9/77.7
Q3	1560001360	S.FET 2SK3019 TL	B	66.4/76.6
Q4	1560000541	S.FET 2SK880-Y(T5RICOM,F)	B	88.8/41.5
Q5	1560000541	S.FET 2SK880-Y(T5RICOM,F)	B	33.3/107.5
Q6	1560000541	S.FET 2SK880-Y(T5RICOM,F)	B	29.6/101.3
Q7	1530002601	S.TRA 2SC4215-O(TE85R,F)	B	72.9/92.5
Q8	1560000541	S.FET 2SK880-Y(T5RICOM,F)	B	92.7/47.7
Q9	1560001360	S.FET 2SK3019 TL	B	39.5/104.5
Q10	1530002851	S.TRA 2SC4116-BL(TE85R,F)	B	88.8/44.6
Q11	1530002851	S.TRA 2SC4116-BL(TE85R,F)	B	29.6/104.4
Q12	1590003230	S.TRA UNR9113J-(TX)	B	65.6/101.6
Q13	1530002851	S.TRA 2SC4116-BL(TE85R,F)	B	88.8/47.7
Q14	1530002851	S.TRA 2SC4116-BL(TE85R,F)	B	29.6/107.5
Q15	1530002851	S.TRA 2SC4116-BL(TE85R,F)	B	92.7/44.6
Q16	1530002851	S.TRA 2SC4116-BL(TE85R,F)	B	33.3/104.5
Q19	1530002601	S.TRA 2SC4215-O(TE85R,F)	B	63.2/106.8
Q20	1530002920	S.TRA 2SC4226-T1 R25	B	38.8/123.1
Q21	1530002920	S.TRA 2SC4226-T1 R25	B	39.6/114.5
Q22	1530002920	S.TRA 2SC4226-T1 R25	B	94.6/64.3
Q23	1530002920	S.TRA 2SC4226-T1 R25	B	95.2/55.4
Q24	1530003311	S.TRA 2SC5107-O(TE85R,F)	B	100.5/58.6
Q25	1530003311	S.TRA 2SC5107-O(TE85R,F)	B	44.9/116.2
Q26	1590001400	S.TRA XP1214(TX)	B	40.5/117.8
Q27	1590001400	S.TRA XP1214(TX)	B	96/59.6
Q28	1590003290	S.TRA UNR9213J-(TX)	B	93.3/59.6
Q29	1590003290	S.TRA UNR9213J-(TX)	T	57.2/41.9
Q30	1590003290	S.TRA UNR9213J-(TX)	B	37.8/117.8
Q31	1590003230	S.TRA UNR9113J-(TX)	T	57.2/39.8
Q32	1530003980	S.TRA 2SC5700WB-TR-E	B	46.5/109.1
Q33	1530003980	S.TRA 2SC5700WB-TR-E	B	102.1/53.4
Q34	1530003311	S.TRA 2SC5107-O(TE85R,F)	B	46.2/123.1
Q35	1530003311	S.TRA 2SC5107-O(TE85R,F)	B	101.9/64.4
Q36	1580000731	S.FET 3SK293(TE85L,F)	B	47.3/136.1
Q37	1530003311	S.TRA 2SC5107-O(TE85R,F)	B	132.5/84.5
Q38	1530002680	S.FET 2SC3357-T1	B	138.1/88.8
Q39	1560000841	S.FET 2SK1829(TE85R,F)	B	53.2/140.8
Q40	1590001190	S.TRA XP6501-(TX),AB	T	101.6/87.4
Q41	1520000460	S.TRA 2SB1132 T100 R	T	101.6/82.8
Q42	1590003290	S.TRA UNR9213J-(TX)	T	13.3/67.6
Q43	1590003290	S.TRA UNR9213J-(TX)	T	138.8/122.9
Q44	1590003290	S.TRA UNR9213J-(TX)	T	122.8/79.2
Q45	1540000550	S.TRA 2SD1664 T100Q	T	117/76.3
Q46	1530002851	S.TRA 2SC4116-BL(TE85R,F)	T	137.4/120.3
Q48	1510000920	S.TRA 2SA1577 T106 Q	T	101.5/77.8
Q49	1590003290	S.TRA UNR9213J-(TX)	T	102.2/73.7
Q52	1590003290	S.TRA UNR9213J-(TX)	T	10.9/131.6
Q53	1590003290	S.TRA UNR9213J-(TX)	T	10.9/129.6
Q56	1590003321	S.FET TPC6103(TE85L,F)	T	7.6/132.6
Q57	1550000190	S.FET 2SJ506STR-E	T	125.2/99.6
Q58	1590003290	S.TRA UNR9213J-(TX)	T	130.2/102.1
Q59	1590000990	S.TRA DTC363EK T146	T	7.6/127.6
Q61	1530002851	S.TRA 2SC4116-BL(TE85R,F)	T	6.8/118.4
Q62	1540000441	S.TRA 2SD1619T-TD-E	T	118.4/18.5
Q63	1560000990	S.FET PMBFJ310	B	66.3/110
Q64	1560000990	S.FET PMBFJ310	B	63.3/110

## [MAIN UNIT]

REF NO.	ORDER NO.	DESCRIPTION	M.	H/V LOCATION
Q65	1530003311	S.TRA 2SC5107-O(TE85R,F)	B	59.6/123.7
Q66	1590003290	S.TRA UNR9213J-(TX)	B	94.9/4.7
Q67	1590003290	S.TRA UNR9213J-(TX)	B	124.9/4.7
Q68	1590003290	S.TRA UNR9213J-(TX)	B	109.9/4.7
Q69	1590003290	S.TRA UNR9213J-(TX)	T	9.5/53.3
Q70	1590003230	S.TRA UNR9113J-(TX)	T	9.5/51
D1	1750001070	S.DIO DAN235ETL	B	57.3/78.6
D2	1750001070	S.DIO DAN235ETL	B	50/79.7
D3	1790001621	S.DIO 1SV308(TPL3,F)	B	70.3/93.4
D4	1790001621	S.DIO 1SV308(TPL3,F)	B	67.8/93.4
D7	1750001150	S.VAR HVC383BTRF-E	B	30.8/122.3
D8	1750001150	S.VAR HVC383BTRF-E	B	30.6/112.7
D9	1750001150	S.VAR HVC383BTRF-E	B	85.6/63.5
D10	1750001150	S.VAR HVC383BTRF-E	B	85.7/53.3
D11	1790001621	S.DIO 1SV308(TPL3,F)	B	63.5/103.1
D12	1790001621	S.DIO 1SV308(TPL3,F)	B	62.7/101.1
D13	1750000711	S.VAR HVC350BTRF-E	B	87.3/66.8
D14	1750000711	S.VAR HVC350BTRF-E	B	87.1/55.4
D15	1750000711	S.VAR HVC350BTRF-E	B	32.6/125.4
D16	1750000711	S.VAR HVC350BTRF-E	B	32/114.5
D17	1720000570	S.VAR MA368(TX)	B	94.6/66.6
D18	1720000570	S.VAR MA368(TX)	B	91.4/57.7
D19	1750000520	S.DIO DAN222TL	T	59.6/39.8
D20	1790001260	S.DIO MA2S077-(TX)	T	38.9/57.8
D21	1750000711	S.VAR HVC350BTRF-E	B	66.1/135.8
D22	1750000711	S.VAR HVC350BTRF-E	B	62.9/135.8
D24	1750000711	S.VAR HVC350BTRF-E	B	56.1/135.9
D27	1790001250	S.DIO MA2S111-(TX)	B	57.2/140.4
D28	1750000711	S.VAR HVC350BTRF-E	B	35.9/134.4
D29	1750000711	S.VAR HVC350BTRF-E	B	37.1/134.4
D31	1750000711	S.VAR HVC350BTRF-E	B	32.4/136.5
D32	1750000711	S.VAR HVC350BTRF-E	B	32.4/135.3
D33	1790001240	S.DIO MA2S728-(TX)	B	37.8/144.2
D34	1790001260	S.DIO MA2S077-(TX)	B	85.4/137.8
D38	1750001360	S.DIO L709CER (9401)	B	87.8/135.6
D40	1750000370	S.DIO DA221 TL	T	112.6/77
D44	1710001061	DIO L407CDB		
D45	1790001211	S.DIO 1SS375-TL-E	B	96.3/138.1
D46	1750000520	S.DIO DAN222TL	T	13.3/131.1
D47	1750000520	S.DIO DAN222TL	T	13.2/129.1
D48	1790000660	S.DIO MA728(TX)	B	121.1/142.5
D49	1790000660	S.DIO MA728(TX)	B	140.6/133
D51	1790001250	S.DIO MA2S111-(TX)	T	10.5/127.1
D53	1790001810	S.VAR AVR-M1005C080MTABB	T	32.5/11.5
D55	1790001810	S.VAR AVR-M1005C080MTABB	T	30.5/11.5
D56	1790001810	S.VAR AVR-M1005C080MTABB	B	33.2/22.5
D59	1790000700	DIO DSA3A1		
D61	1160000070	S.DIO DAN202K T146	T	118.4/14.3
D62	1750000431	S.DIO HSB88WSTR-E	B	68.3/123.3
D63	1790001250	S.DIO MA2S111-(TX)	B	34.1/20.7
D64	1750000370	S.DIO DA221 TL	T	63.2/93.9
D65	1750000370	S.DIO DA221 TL	T	65.2/93.9
D66	1750000370	S.DIO DA221 TL	T	67.2/93.9
D67	1750000370	S.DIO DA221 TL	T	62.5/105.6
D68	1750000370	S.DIO DA221 TL	T	60.5/104.7
D69	1750000370	S.DIO DA221 TL	T	69.2/93.9
D70	1750000370	S.DIO DA221 TL	T	71.2/93.9
D71	1750000370	S.DIO DA221 TL	T	69.4/109.5
D72	1750000370	S.DIO DA221 TL	T	71.5/109.5
D73	1750000370	S.DIO DA221 TL	T	73.5/109.5
D74	1750000370	S.DIO DA221 TL	T	75.6/109.5
D75	1790001250	S.DIO MA2S111-(TX)	B	41/38.6
D76	1790001250	S.DIO MA2S111-(TX)	B	26.4/41.3
D77	1790001250	S.DIO MA2S111-(TX)	B	49.2/29.9
D78	1730002360	S.ZEN MA8062-M(TX)	B	52.3/29.9
FI1	2020001520	CER CFWLA450KFFA-B0 (CFWS450F)		
FI2	2020001460	CER CFWLA450KHFA-B0 (CFWS450HT)		
FI3	2030000500	S.MON DSF753SBF 46.35 MHz(FL-401)	B	72/101
FI4	2030000670	S.MON DSF753SBF 46.35 MHz (FL-420)	B	63.4/91.1
FI5	2040001440	S.LC NFE31PT152Z1E9L (NFM60R20T152)	T	114.2/110.3
FI6	2040001440	S.LC NFE31PT152Z1E9L (NFM60R20T152)	T	114.2/113.4
FI7	2040001440	S.LC NFE31PT152Z1E9L (NFM60R20T152)	T	114.2/116.5
X1	6050012380	S.XTA CR-826 DSA535SD 15.3 MHz	B	128.6/45.3
X2	6050012380	S.XTA CR-826 DSA535SD 15.3 MHz	B	35.6/72.3
X3	6070000300	S.DIS JTBM450CX24 <JJE>	B	63.5/83.5
X4	6050012350	S.XTA CR-817 DSB321SC 12.288 MHz	B	52.8/38.2
X5	6050012680	S.XTA CR-858(SMD-49/18.432 MHz) <JJE>	T	46.9/52.7
L1	6200004660	S.COI MLF1608A 1R8K-T	B	115.6/39.2
L2	6200004660	S.COI MLF1608A 1R8K-T	B	23.6/82.4
L3	6200004480	S.COI MLF1608D R8K-T	B	39.4/79.3
L4	6200003540	S.COI MLF1608D R22K-T	B	36.9/76.9

M.=Mounted side (T: Mounted on the Top side, B: Mounted on the Bottom side)  
S.=Surface mount

[MAIN UNIT]

REF NO.	ORDER NO.	DESCRIPTION	M.	H/V LOCATION
L5	6200005671	S.COI ELJRE 12NGFA [USA-01]	B	102.7/46.7
	6200005671	S.COI ELJRE 12NGFA [EXP-01]		
	6200005661	S.COI ELJRE 10NGFA [USA-02]		
	6200005661	S.COI ELJRE 10NGFA [EXP-02]		
	6200005671	S.COI ELJRE 12NGFA [EUR-01]		
L6	6200005671	S.COI ELJRE 12NGFA	B	44.6/99.3
L8	6200004741	S.COI NLV25T-1R2J	B	28.5/121.7
L9	6200004741	S.COI NLV25T-1R2J	B	28.5/124.9
L10	6200004741	S.COI NLV25T-1R2J	B	28.5/114.1
L11	6200004741	S.COI NLV25T-1R2J	B	83.7/63.1
L12	6200004741	S.COI NLV25T-1R2J	B	83.7/54.6
L13	6200004741	S.COI NLV25T-1R2J	B	30.6/117.2
L14	6200004741	S.COI NLV25T-1R2J	B	84.2/66.2
L15	6200004741	S.COI NLV25T-1R2J	B	84.2/57.7
L18	6200009260	S.COI C3328A-5N0J-A	B	88.7/63.1
L19	6200009260	S.COI C3328A-5N0J-A	B	89.8/54
L20	6200009390	S.COI C3328A-8N0J-A	B	33.2/121.7
L21	6200009390	S.COI C3328A-8N0J-A	B	34.7/113.1
L22	6200003550	S.COI MLF1608A 4R7K-T	B	73.4/109.9
L23	6200002861	S.COI NLV25T-4R7J	B	57.6/108.9
L24	6200010740	S.COI C2520C-R27G-A	B	70/109.1
L25	6200004741	S.COI NLV25T-1R2J	B	97.1/64.6
L26	6200004741	S.COI NLV25T-1R2J	B	98.1/53.9
L27	6130002961	S.COI #617DB-1327=P3	B	68.3/117
L28	6200005711	S.COI ELJRE 27NGFA	B	62.3/123.6
L29	6200005721	S.COI ELJRE 33NGFA	B	102.6/58.6
L30	6200005721	S.COI ELJRE 33NGFA	B	46.9/116.2
L31	6200002861	S.COI NLV25T-4R7J	T	91.1/19.9
L32	6130002961	S.COI #617DB-1327=P3	B	68.3/128.7
L33	6200005671	S.COI ELJRE 12NGFA	B	47.3/107.1
L34	6200005711	S.COI ELJRE 27NGFA [USA-01]	B	61.1/117.5
	6200005711	S.COI ELJRE 27NGFA [EXP-01]		
	6200005691	S.COI ELJRE 18NGFA [USA-02]		
	6200005691	S.COI ELJRE 18NGFA [EXP-02]		
	6200005711	S.COI ELJRE 27NGFA [EUR-01]		
L35	6200005671	S.COI ELJRE 12NGFA [USA-01]	B	102.7/51.6
	6200005671	S.COI ELJRE 12NGFA [EXP-01]		
	6200005661	S.COI ELJRE 10NGFA [USA-02]		
	6200005661	S.COI ELJRE 10NGFA [EXP-02]		
	6200005671	S.COI ELJRE 12NGFA [EUR-01]		
L36	6200005711	S.COI ELJRE 27NGFA	B	44.3/123.1
L37	6200005711	S.COI ELJRE 27NGFA [USA-01]	B	61.1/120.1
	6200005711	S.COI ELJRE 27NGFA [EXP-01]		
	6200005691	S.COI ELJRE 18NGFA [USA-02]		
	6200005691	S.COI ELJRE 18NGFA [EXP-02]		
	6200005711	S.COI ELJRE 27NGFA [EUR-01]		
L38	6200005711	S.COI ELJRE 27NGFA	B	100/64.4
L39	6200009320	S.COI C3328A-12NG-A	B	70.8/137.3
L40	6200009320	S.COI C3328A-12NG-A	B	59.5/135.7
L41	6200009320	S.COI C3328A-12NG-A	B	51.4/136.3
L42	6200005711	S.COI ELJRE 27NGFA	B	134.7/83.8
L43	6200005711	S.COI ELJRE 27NGFA	B	142/87.1
L44	6200010290	S.COI C6328A-22NG-A [USA-01]	B	41.9/136.2
	6200010290	S.COI C6328A-22NG-A [EXP-01]		
	6200013490	S.COI C6328A-17NG-A [USA-02]		
	6200013490	S.COI C6328A-17NG-A [EXP-02]		
	6200010290	S.COI C6328A-22NG-A [EUR-01]		
L45	6200005641	S.COI ELJRE 6N8ZFA	B	142.7/90.6
L46	6200005691	S.COI ELJRE 18NGFA [USA-01]	B	142/94.6
	6200005691	S.COI ELJRE 18NGFA [EXP-01]		
	6200005691	S.COI ELJRE 18NGFA [USA-02]		
	6200005691	S.COI ELJRE 18NGFA [EXP-02]		
	6200005671	S.COI ELJRE 12NGFA [EUR-01]		
L47	6200010290	S.COI C6328A-22NG-A [USA-01]	B	34.8/140.3
	6200010290	S.COI C6328A-22NG-A [EXP-01]		
	6200013490	S.COI C6328A-17NG-A [USA-02]		
	6200013490	S.COI C6328A-17NG-A [EXP-02]		
	6200010290	S.COI C6328A-22NG-A [EUR-01]		
L48	6200010100	S.COI C2012C-33NG-A	B	39.7/142.2
L49	6200010040	S.COI AS100340-10N	B	95.5/119.7
L50	6200005691	S.COI ELJRE 18NGFA	B	88/137.7
L52	6200010420	S.COI FHW1210HC 1R0JGT <JJE>	B	86.6/122.3
L53	6200010150	S.COI AS080340-15N	B	92.5/134.3
L54	6200010150	S.COI AS080340-15N	B	99.7/133.8
L55	6200010150	S.COI AS080340-15N	B	107.5/135.8
L56	6200010150	S.COI AS080340-15N	B	114.4/138.9
L57	6200010150	S.COI AS080340-15N	B	144.6/142.1
L58	6200002861	S.COI NLV25T-4R7J	T	55.4/37.5
L59	6200010420	S.COI FHW1210HC 1R0JGT <JJE>	B	147.1/146.2
L60	6200010420	S.COI FHW1210HC 1R0JGT <JJE>	B	24.5/145
L61	6200002961	S.COI NLV32T-4R7J	T	118.4/23.8
L65	6200004741	S.COI NLV25T-1R2J	B	41.3/123.3
L66	6200004741	S.COI NLV25T-1R2J	B	42.8/113.5
R1	7030005700	S.RES ERJ2GEJ 274 X (270K)	T	54.5/63.5
R2	7030005050	S.RES ERJ2GEJ 103 X (10K)	T	59/61.8
R3	7030005240	S.RES ERJ2GEJ 473 X (47K)	T	62.4/69.6
R4	7030007340	S.RES ERJ2GEJ 153 X (15K)	B	57.3/80.1
R6	7030007300	S.RES ERJ2GEJ 332 X (3.3K)	T	9.5/57.1
R7	7030010040	S.RES ERJ2GEJ-JPW	T	61.6/66.3
R8	7030005160	S.RES ERJ2GEJ 105 X (1M)	T	24.9/70.4
R9	7030005160	S.RES ERJ2GEJ 105 X (1M)	T	25.8/70.4
R10	7030005160	S.RES ERJ2GEJ 105 X (1M)	T	26.7/70.4
R12	7510001730	S.THE ERTJOEP 473J	B	129.1/49.3
R13	7030005090	S.RES ERJ2GEJ 104 X (100K)	B	130.8/49.3
R15	7030007340	S.RES ERJ2GEJ 153 X (15K)	B	54.5/78.4
R17	7030004980	S.RES ERJ2GEJ 101 X (100)	T	19.8/68.8
R18	7030007340	S.RES ERJ2GEJ 153 X (15K)	B	55.3/79.2
R20	7030008300	S.RES ERJ2GEJ 184 X (180K)	T	56.2/63.5
R22	7410001130	S.ARR EXB28V102JX	B	122.6/39
R23	7410001130	S.ARR EXB28V102JX	B	23.1/76.3
R25	7030004970	S.RES ERJ2GEJ 470 X (47)	B	65.3/79.4
R26	7030010040	S.RES ERJ2GEJ-JPW	T	57.8/64.5

[MAIN UNIT]

REF NO.	ORDER NO.	DESCRIPTION	M.	H/V LOCATION
R27	7030005120	S.RES ERJ2GEJ 102 X (1K)	T	57.8/51
R29	7030007570	S.RES ERJ2GEJ 122 X (1.2K)	B	35.8/75.5
R30	7030007340	S.RES ERJ2GEJ 153 X (15K)	B	52.8/81.1
R32	7030007340	S.RES ERJ2GEJ 153 X (15K)	B	51.2/78.3
R33	7030007340	S.RES ERJ2GEJ 153 X (15K)	B	48.4/78.2
R34	7030005240	S.RES ERJ2GEJ 473 X (47K)	T	27.1/68.1
R35	7030005240	S.RES ERJ2GEJ 473 X (47K)	T	28/68.1
R36	7030005240	S.RES ERJ2GEJ 473 X (47K)	T	28.9/68.1
R38	7030005230	S.RES ERJ2GEJ 334 X (330K)	T	27.6/70.4
R39	7030005230	S.RES ERJ2GEJ 334 X (330K)	T	28.6/70.4
R40	7030005230	S.RES ERJ2GEJ 334 X (330K)	T	29.5/70.4
R41	7030005240	S.RES ERJ2GEJ 473 X (47K)	B	68.2/78.2
R42	7030007060	S.RES ERJ2GEJ 684X (680K)	B	34.6/75.9
R43	7030007290	S.RES ERJ2GEJ 222 X (2.2K)	B	62.8/77.3
R44	7030005030	S.RES ERJ2GEJ 152 X (1.5K)	B	71.4/78.2
R45	7030004970	S.RES ERJ2GEJ 470 X (47)	B	64.6/75.5
R46	7030005000	S.RES ERJ2GEJ 471 X (470)	T	52.7/57.1
R47	7030005290	S.RES ERJ2GEJ 682 X (6.8K)	B	64.6/76.4
R48	7030005030	S.RES ERJ2GEJ 152 X (1.5K)	B	62.8/76.4
R49	7030010040	S.RES ERJ2GEJ-JPW	T	55.2/57
R52	7030004980	S.RES ERJ2GEJ 101 X (100)	B	34.1/56.4
R53	7030005210	S.RES ERJ2GEJ 822 X (8.2K)	B	16.8/57.6
R54	7030005000	S.RES ERJ2GEJ 471 X (470)	B	19.4/64.3
R56	7030004970	S.RES ERJ2GEJ 470 X (47)	B	12.1/90.4
R57	7030005040	S.RES ERJ2GEJ 472 X (4.7K)	B	62.8/75.5
R58	7030008290	S.RES ERJ2GEJ 183 X (18K)	B	56.5/49
R59	7030008290	S.RES ERJ2GEJ 183 X (18K)	B	57.4/49
R60	7030005000	S.RES ERJ2GEJ 471 X (470)	B	33.1/75.2
R62	7030005120	S.RES ERJ2GEJ 102 X (1K)	B	18.5/62.5
R63	7030005090	S.RES ERJ2GEJ 104 X (100K)	T	55.5/60
R65	7030005000	S.RES ERJ2GEJ 471 X (470)	B	125.1/47.3
R66	7030004980	S.RES ERJ2GEJ 101 X (100)	B	56.5/50.6
R68	7030005040	S.RES ERJ2GEJ 472 X (4.7K)	B	67.5/86.7
R69	7030005120	S.RES ERJ2GEJ 102 X (1K)	B	32.7/83
R71	7030005240	S.RES ERJ2GEJ 473 X (47K)	B	31/62.6
R72	7030004980	S.RES ERJ2GEJ 101 X (100)	B	57.6/44.2
R75	7030005110	S.RES ERJ2GEJ 224 X (220K)	B	39.9/71.1
R76	7030005120	S.RES ERJ2GEJ 102 X (1K)	B	91/41.5
R77	7030005580	S.RES ERJ2GEJ 560 X (56)	B	119.7/48.8
R78	7030005120	S.RES ERJ2GEJ 102 X (1K)	B	29.6/99.3
R79	7030005580	S.RES ERJ2GEJ 560 X (56)	B	32.7/79.5
R80	7030004970	S.RES ERJ2GEJ 470 X (47)	B	23.5/41.1
R81	7030007250	S.RES ERJ2GEJ 220 X (22)	B	49.9/50.5
R82	7030008400	S.RES ERJ2GEJ 182 X (1.8K)	B	56/44.2
R84	7030007290	S.RES ERJ2GEJ 222 X (2.2K)	B	95.4/45.4
R85	7030007290	S.RES ERJ2GEJ 222 X (2.2K)	B	36.9/105.6
R87	7030005090	S.RES ERJ2GEJ 104 X (100K)	B	73.7/81.1
R88	7030005530	S.RES ERJ2GEJ 100 X (10)	B	39/71.1
R89	7030008400	S.RES ERJ2GEJ 182 X (1.8K)	B	67.1/83.2
R90	7030008010	S.RES ERJ2GEJ 123 X (12K)	T	54.5/73.3
R91	7030007570	S.RES ERJ2GEJ 122 X (1.2K)	B	94.5/45.4
R92	7030005290	S.RES ERJ2GEJ 682 X (6.8K)	B	86.7/41.5
R93	7030007570	S.RES ERJ2GEJ 122 X (1.2K)	B	35.1/105.6
R94	7030005290	S.RES ERJ2GEJ 682 X (6.8K)	B	28/98.3
R97	7410001170	S.ARR EXB28V470JX	B	42.9/49.9
R98	7030005530	S.RES ERJ2GEJ 100 X (10)	B	70.7/90.4
R99	7030005110	S.RES ERJ2GEJ 224 X (220K)	B	70.7/91.3
R100	7030005600	S.RES ERJ2GEJ 273 X (27K)	B	69.1/92.3
R101	7030004980	S.RES ERJ2GEJ 101 X (100)	B	86.7/43.7
R102	7030004980	S.RES ERJ2GEJ 101 X (100)	B	31.5/105.6
R103	7030004980	S.RES ERJ2GEJ 101 X (100)	B	27.8/103.9
R104	7030005050	S.RES ERJ2GEJ 103 X (10K)	B	86.7/45.4
R105	7030005050	S.RES ERJ2GEJ 103 X (10K)	B	31.5/109
R106	7030005050	S.RES ERJ2GEJ 103 X (10K)	B	27.8/105.6
R107	7030004980	S.RES ERJ2GEJ 101 X (100)	B	90.8/45.4
R108	7030005030	S.RES ERJ2GEJ 152 X (1.5K)	B	90.8/43.7
R109	7030005090	S.RES ERJ2GEJ 104 X (100K)	B	65.7/100.1
R110	7030005810	S.RES RR0510P-152-D (1.5K)	B	31.5/103.9
R111	7030005090	S.RES ERJ2GEJ 104 X (100K)	B	37.8/105.6
R112	7030005220	S.RES ERJ2GEJ 223 X (22K)	B	86.7/47.1



[MAIN UNIT]

REF NO.	ORDER NO.	DESCRIPTION	M.	H/V LOCATION
R151	7030005110	S.RES ERJ2GEJ 224 X (220K)	B	88.9/58.2
R152	7030005070	S.RES ERJ2GEJ 683 X (68K)	B	65.2/107
R153	7030005000	S.RES ERJ2GEJ 471 X (470)	B	61.4/104.4
R154	7030006020	S.RES RR0510P-682-D (6.8K)	B	36.8/121.9
R155	7030006020	S.RES RR0510P-682-D (6.8K)	B	36.5/120.7
R156	7030006020	S.RES RR0510P-682-D (6.8K)	B	37.4/112.2
R157	7030005530	S.RES ERJ2GEJ 100 X (10)	B	92.4/66.6
R158	7030005530	S.RES ERJ2GEJ 100 X (10)	B	88.9/57.2
R159	7030005530	S.RES ERJ2GEJ 100 X (10)	B	65.2/106.1
R160	7030010040	S.RES ERJ2GEJ-JPW	B	36.8/123.7
R161	7030006020	S.RES RR0510P-682-D (6.8K)	B	37.6/113.5
R162	7030010040	S.RES ERJ2GEJ-JPW	B	37.6/115.3
R163	7030006020	S.RES RR0510P-682-D (6.8K)	B	92.4/62
R164	7030006020	S.RES RR0510P-682-D (6.8K)	B	92.7/52.9
R165	7030009320	S.RES ERJ2GEJ 4R7 X (4.7)	B	92.4/65.2
R166	7030009320	S.RES ERJ2GEJ 4R7 X (4.7)	B	93.1/56.3
R167	7030007250	S.RES ERJ2GEJ 220 X (22)	B	58.3/111.1
R168	7030006020	S.RES RR0510P-682-D (6.8K)	B	92.4/63.4
R169	7030006020	S.RES RR0510P-682-D (6.8K)	B	93.1/54.5
R171	7030011920	S.RES RR0510P-561-D (560)	B	41/120.7
R172	7030009820	S.RES RR0510P-681-D (680)	B	97/62
R173	7030009820	S.RES RR0510P-681-D (680)	B	97/56.5
R174	7030009820	S.RES RR0510P-681-D (680)	B	41.4/115.7
R175	7030005530	S.RES ERJ2GEJ 100 X (10)	B	73.6/108.8
R176	7030005310	S.RES ERJ2GEJ 124 X (120K)	B	100.5/56.8
R177	7030005310	S.RES ERJ2GEJ 124 X (120K)	B	44.9/114.4
R178	7030004980	S.RES ERJ2GEJ 101 X (100)	B	100.5/59.9
R179	7030004980	S.RES ERJ2GEJ 101 X (100)	B	44.9/113.5
R180	7030005050	S.RES ERJ2GEJ 103 X (10K)	B	36/109
R181	7030005050	S.RES ERJ2GEJ 103 X (10K)	B	95.4/48.8
R182	7030007300	S.RES ERJ2GEJ 332 X (3.3K)	B	68.5/107
R185	7030010040	S.RES ERJ2GEJ-JPW	B	62.3/117.5
R186	7030005120	S.RES ERJ2GEJ 102 X (1K)	T	39.2/50.7
R187	7030008010	S.RES ERJ2GEJ 123 X (12K)	T	41.5/55.9
R188	7410001150	S.ARR EXB28V471JX	T	48.5/41.1
R189	7030005090	S.RES ERJ2GEJ 104 X (100K)	T	55.6/39.5
R190	7030008010	S.RES ERJ2GEJ 123 X (12K)	T	43.1/55.9
R191	7030005000	S.RES ERJ2GEJ 471 X (470)	B	44/109.1
R192	7030005110	S.RES ERJ2GEJ 224 X (220K)	B	44.9/109.1
R194	7030004980	S.RES ERJ2GEJ 101 X (100)	B	100.5/51.7
R195	7030005110	S.RES ERJ2GEJ 224 X (220K)	B	100.5/53.4
R196	7030007260	S.RES ERJ2GEJ 330 X (33)	B	48/120.7
R197	7030005050	S.RES ERJ2GEJ 103 X (10K)	T	40.5/50.6
R198	7030007260	S.RES ERJ2GEJ 330 X (33)	B	103.7/62
R199	7030005050	S.RES ERJ2GEJ 103 X (10K)	T	67.6/57.5
R200	7030004980	S.RES ERJ2GEJ 101 X (100)	B	43.1/122.6
R201	7030005070	S.RES ERJ2GEJ 683 X (68K)	B	48/122.6
R202	7030005160	S.RES ERJ2GEJ 105 X (1M)	T	41.4/48.6
R204	7030005050	S.RES ERJ2GEJ 103 X (10K)	T	54.7/39.5
R205	7030008010	S.RES ERJ2GEJ 123 X (12K)	T	34.5/57.9
R207	7030005070	S.RES ERJ2GEJ 683 X (68K)	B	103.7/64
R208	7030010040	S.RES ERJ2GEJ-JPW	B	46.2/120.7
R209	7030005000	S.RES ERJ2GEJ 471 X (470)	T	67.6/56
R212	7410001140	S.ARR EXB28V104JX	T	52.3/41.1
R213	7030005530	S.RES ERJ2GEJ 100 X (10)	T	41.4/47.7
R214	7030004980	S.RES ERJ2GEJ 101 X (100)	B	98.9/64
R215	7030010040	S.RES ERJ2GEJ-JPW	B	100.9/62
R216	7410001140	S.ARR EXB28V104JX	T	17.3/52.4
R217	7410001140	S.ARR EXB28V104JX	T	38.6/56
R218	7030005110	S.RES ERJ2GEJ 224 X (220K)	B	65/137.9
R220	7410001140	S.ARR EXB28V104JX	T	15.2/50.7
R222	7410001140	S.ARR EXB28V104JX	T	36.1/56
R223	7030005050	S.RES ERJ2GEJ 103 X (10K)	B	64/136.3
R224	7410001150	S.ARR EXB28V471JX	T	30.4/53.1
R225	7030005110	S.RES ERJ2GEJ 224 X (220K)	B	64/137.9
R226	7030005110	S.RES ERJ2GEJ 224 X (220K)	B	57.2/136.1
R227	7410001150	S.ARR EXB28V471JX	T	42.9/28.9
R230	7410001150	S.ARR EXB28V471JX	T	28.6/50.9
R231	7030005010	S.RES ERJ2GEJ 681 X (680) [USA-01]	B	55/138
	7030005010	S.RES ERJ2GEJ 681 X (680) [EXP-01]	B	
	7030005010	S.RES ERJ2GEJ 681 X (680) [USA-02]	B	
	7030005010	S.RES ERJ2GEJ 681 X (680) [EXP-02]	B	
	7030007280	S.RES ERJ2GEJ 331 X (330) [EUR-01]	B	
R232	7410001150	S.ARR EXB28V471JX	T	25.9/49.4
R233	7030005530	S.RES ERJ2GEJ 100 X (10)	B	54.1/136.1
R234	7410001150	S.ARR EXB28V471JX	T	42.5/25.7
R235	7410001150	S.ARR EXB28V471JX	T	24.2/47.6
R236	7030005090	S.RES ERJ2GEJ 104 X (100K)	B	133.1/82.8
R237	7030004970	S.RES ERJ2GEJ 470 X (47)	B	48.4/138.3
R238	7410001150	S.ARR EXB28V471JX	T	45.7/28.9
R239	7410001150	S.ARR EXB28V471JX	T	22.4/45.8
R240	7030004980	S.RES ERJ2GEJ 101 X (100)	B	135.8/84.5
R241	7030005710	S.RES ERJ2GEJ 121 X (120)	B	48.4/133.8
R242	7030009320	S.RES ERJ2GEJ 4R7 X (4.7)	B	47.4/138.3
R243	7030005090	S.RES ERJ2GEJ 104 X (100K)	B	46.4/138.3
R244	7410001150	S.ARR EXB28V471JX	T	39.7/25.8
R245	7410001150	S.ARR EXB28V471JX	T	20.2/42.4
R246	7030005240	S.RES ERJ2GEJ 473 X (47K)	B	44.4/136.1
R247	7030008290	S.RES ERJ2GEJ 183 X (18K)	B	47.4/140.4
R248	7030005600	S.RES ERJ2GEJ 273 X (27K)	B	137.4/85.8
R253	7030004970	S.RES ERJ2GEJ 470 X (47)	B	138.8/85.4
R255	7030008400	S.RES ERJ2GEJ 182 X (1.8K)	B	51.4/140.4
R257	7410001140	S.ARR EXB28V104JX	T	14.5/45.7
R258	7030005110	S.RES ERJ2GEJ 224 X (220K)	B	58.3/140.4
R259	7030005170	S.RES ERJ2GEJ 474 X (470K)	B	56.1/140.4
R260	7030005050	S.RES ERJ2GEJ 103 X (10K)	T	144.6/121.4
R261	7030005050	S.RES ERJ2GEJ 103 X (10K)	T	52.5/25.2
R262	7030005090	S.RES ERJ2GEJ 104 X (100K)	T	51.9/22.8
R263	7410001140	S.ARR EXB28V104JX	T	46.2/20
R264	7410001140	S.ARR EXB28V104JX	T	50.2/24
R265	7030007280	S.RES ERJ2GEJ 331 X (330)	T	143/121.4
R266	7030005090	S.RES ERJ2GEJ 104 X (100K)	B	34.6/133.5
R267	7410001140	S.ARR EXB28V104JX	T	14.8/43.1
R268	7410001150	S.ARR EXB28V471JX	T	45.7/31.8

[MAIN UNIT]

REF NO.	ORDER NO.	DESCRIPTION	M.	H/V LOCATION
R269	7030007270	S.RES ERJ2GEJ 151 X (150)	B	142.6/92.6
R270	7030005050	S.RES ERJ2GEJ 103 X (10K)	B	30.6/134
R271	7030005090	S.RES ERJ2GEJ 104 X (100K)	T	23.8/26.7
R272	7410001150	S.ARR EXB28V471JX	T	17.9/32.3
R273	7410001150	S.ARR EXB28V471JX	T	17.9/35.1
R274	7030005090	S.RES ERJ2GEJ 104 X (100K)	B	31.5/134
R277	7030004980	S.RES ERJ2GEJ 101 X (100)	T	143.4/126.6
R278	7030005090	S.RES ERJ2GEJ 104 X (100K)	T	13.9/65.6
R279	7030007290	S.RES ERJ2GEJ 222 X (2.2K)	T	103.6/88.4
R280	7030004990	S.RES ERJ2GEJ 221 X (220)	T	138.4/128.2
R281	7410001150	S.ARR EXB28V471JX	T	21.3/31.8
R282	7030005090	S.RES ERJ2GEJ 104 X (100K)	T	37.8/20.3
R283	7030005100	S.RES ERJ2GEJ 154 X (150K)	T	141.5/126.6
R285	7030005050	S.RES ERJ2GEJ 103 X (10K)	T	101.6/79.5
R287	7410001140	S.ARR EXB28V104JX	T	49.7/27.7
R288	7030005110	S.RES ERJ2GEJ 224 X (220K)	T	136.8/124.7
R289	7030006070	S.RES ERJ12YJ101U (100)	B	86.9/117.5
R290	7030005110	S.RES ERJ2GEJ 224 X (220K)	T	137.2/122.6
R291	7030005040	S.RES ERJ2GEJ 472 X (4.7K)	T	139.2/121.2
R292	7030005050	S.RES ERJ2GEJ 103 X (10K)	T	139.3/128.2
R295	7030006610	S.RES ERJ2GEJ 394 X (390K)	T	136.3/122.6
R296	7030007300	S.RES ERJ2GEJ 332 X (3.3K)	T	121.8/77.2
R297	7030007300	S.RES ERJ2GEJ 332 X (3.3K)	T	122.8/77.2
R298	7030000440	S.RES MCR10EZHJ 3.3K (332)	T	120.4/77.3
R299	7030004980	S.RES ERJ2GEJ 101 X (100)	B	29.1/119.4
R300	7030005530	S.RES ERJ2GEJ 100 X (10)	T	47.6/73.1
R301	7030008300	S.RES ERJ2GEJ 184 X (180K)	B	85.7/131
R303	7410001150	S.ARR EXB28V471JX	T	47.7/68.4
R304	7030005050	S.RES ERJ2GEJ 103 X (10K)	B	95.4/135.9
R306	7520000260	S.POS PRF18BB471QB1RB	B	87.3/130.2
R308	7030008010	S.RES ERJ2GEJ 123 X (12K) [USA-01]	T	140.7/128.3
	7030008010	S.RES ERJ2GEJ 123 X (12K) [EXP-01]	T	
	7030008010	S.RES ERJ2GEJ 123 X (12K) [USA-02]	T	
	7030008010	S.RES ERJ2GEJ 123 X (12K) [EXP-02]	T	
	7030007340	S.RES ERJ2GEJ 153 X (15K) [EUR-01]	T	
R309	7030005040	S.RES ERJ2GEJ 472 X (4.7K)	T	102.2/75.7
R313	7030005050	S.RES ERJ2GEJ 103 X (10K)	T	103.5/77.8
R315	7030005700	S.RES ERJ2GEJ 274 X (270K)	B	98.6/137.3
R316	7030005050	S.RES ERJ2GEJ 103 X (10K)	T	11.2/128.2
R320	7030005090	S.RES ERJ2GEJ 104 X (100K)	T	15/124.1
R321	7030003320	S.RES ERJ3GEYJ 101 V (100)	B	119.5/142.1
R322	7030007350	S.RES ERJ2GEJ 393 X (39K)	B	119.4/144.2
R324	7030005050	S.RES ERJ2GEJ 103 X (10K)	B	31.3/12
R325	7030005120	S.RES ERJ2GEJ 102 X (1K)	B	32.3/12
R326	7030005240	S.RES ERJ2GEJ 473 X (47K)	T	13.2/125.7
R327	7030000220	S.RES MCR10EZHJ 47 (470)	B	119.7/132.8
R328	7030000260	S.RES MCR10EZHJ 100 (101)	B	139.3/144.3
R331	7030004980	S.RES ERJ2GEJ 101 X (100)	T	12/120
R332	7030003320	S.RES ERJ3GEYJ 101 V (100)	B	139.5/135
R333	7030007350	S.RES ERJ2GEJ 393 X (39K)	B	139.3/131.4
R334	7030005651	S.RES ERA3YKD 304V (300K)	T	57.8/30.5
R335	7030005871	S.RES ERA3YKD 104V (100K)	T	55.9/29.7
R336	7030005110	S.RES ERJ2GEJ 224 X (220K)	T	12/120.9
R337	7030005110	S.RES ERJ2GEJ 224 X (220K)	T	13.2/120.6
R339	7030005090	S.RES ERJ2GEJ 104 X (100K)	T	12/125.3
R341	7030005050	S.RES ERJ2GEJ 103 X (10K)	B	33.3/12
R342	7030005090	S.RES ERJ2GEJ 104 X (100K)	B	45.3/56.9
R346	7410001150	S.ARR EXB28V471JX	T	43.5/73.8
R347	7030005000	S.RES ERJ2GEJ 471 X (470)	T	9.8/132.9
R348	7030000620	S.RES MCR10EZHJ 100 K (104)	B	147.2/150.9
R349	7030000620	S.RES MCR10EZHJ 100 K (104)	B	26/149.7
R350	7030003560	S.RES ERJ3GEYJ 103 V (10K)	B	6.4/131
R352	7030005040	S.RES ERJ2GEJ 472 X (4.7K)	T	10.2/125.3
R353	7030005240	S.RES ERJ2GEJ 473 X (47K)	B	55.8/56.9
R354	7030005700	S.RES ERJ2GEJ 274 X (270K)	T	125.2/103.6
R355	7030005090	S.RES ERJ2GEJ 104 X (100K)	T	129.2/103.6
R356	7030005050	S.RES ERJ2GEJ 103 X (10K)	T	9.8/134.5
R357	7030003560	S.RES ERJ3GEYJ 103 V (10K)	B	10.1/150.2
R362	7540000290	ABS ERZV10D220		
R364	7030005110	S.RES ERJ2GEJ 224 X (220K)	T	65.1/71.2
R365	7030005050	S.RES ERJ2GEJ 103 X (10K)	T	7.4/120.7
R366	7030007290	S.RES ERJ2GEJ 222 X (2.2K)	T	7/123.5
R367	7030004980	S.RES ERJ2GEJ 101 X (100)	T	9.7/117.3
R368	7030008300	S.RES ERJ2GEJ 184 X (180K)	T	8.5/117.8
R369	7030005230	S.RES ERJ2GEJ 334 X (330K)	T	9.7/118.2
R370	7030008240	S.RES ERJ2GEJ 271 X (270)	T	6.1/120.7
R371	7030010000	S.RES ERJ2GEJ-JPW	T	5/117.3
R372	7030005000	S.RES ERJ2GEJ 471 X (470)	T	115.3/15.8
R373				



[MAIN UNIT]

REF NO.	ORDER NO.	DESCRIPTION	M.	H/V LOCATION
R438	7410001140	S.ARR EXB28V104JX	B	34.4/47.7
R443	7030005000	S.RES ERJ2GEJ 471 X (470)	T	60.4/59.2
R444	7030005240	S.RES ERJ2GEJ 473 X (47K)	B	13.5/33.6
R445	7030005240	S.RES ERJ2GEJ 473 X (47K)	B	13.5/36.1
R446	7030005240	S.RES ERJ2GEJ 473 X (47K)	B	13.5/37.4
R447	7030005090	S.RES ERJ2GEJ 104 X (100K)	T	50.2/19.2
R448	7030005090	S.RES ERJ2GEJ 104 X (100K)	T	49.3/19.2
R449	7030005170	S.RES ERJ2GEJ 474 X (470K)	T	39.5/19.2
R450	7030005050	S.RES ERJ2GEJ 103 X (10K)	T	50.2/16.5
R453	7030005120	S.RES ERJ2GEJ 102 X (1K)	T	52/13.9
R454	7030005120	S.RES ERJ2GEJ 102 X (1K)	B	94.9/2.7
R455	7030005010	S.RES ERJ2GEJ 681 X (680)	B	124.9/2.7
R456	7030005120	S.RES ERJ2GEJ 102 X (1K)	B	109.9/2.7
R467	7030005240	S.RES ERJ2GEJ 473 X (47K)	B	38/44.6
R468	7410001140	S.ARR EXB28V104JX	B	31.8/48.5
R469	7030005090	S.RES ERJ2GEJ 104 X (100K)	B	32.6/44.6
R470	7030005090	S.RES ERJ2GEJ 104 X (100K)	T	10.9/20.2
R471	7030005090	S.RES ERJ2GEJ 104 X (100K)	B	47.7/44.2
R472	7030005240	S.RES ERJ2GEJ 473 X (47K)	B	4.8/36.1
R473	7030005090	S.RES ERJ2GEJ 104 X (100K)	B	46.2/44.6
R474	7030005530	S.RES ERJ2GEJ 100 X (10)	B	15.5/55.3
R475	7030005240	S.RES ERJ2GEJ 473 X (47K)	B	9/56.2
R476	7030005090	S.RES ERJ2GEJ 104 X (100K)	B	15/53.5
R477	7030005080	S.RES ERJ2GEJ 823 X (82K)	B	15/52.6
R478	7030005050	S.RES ERJ2GEJ 103 X (10K)	B	9.1/54.7
R479	7030005110	S.RES ERJ2GEJ 224 X (220K)	T	64.2/69.6
R480	7030005050	S.RES ERJ2GEJ 103 X (10K)	B	15.6/61.5
R481	7030005050	S.RES ERJ2GEJ 103 X (10K)	B	16.5/59.9
R482	7410001150	S.ARR EXB28V471JX	T	19.6/45.1
R483	7030005090	S.RES ERJ2GEJ 104 X (100K)	T	31.2/56.5
R484	7030005090	S.RES ERJ2GEJ 104 X (100K)	B	28.8/50.9
R485	7410001150	S.ARR EXB28V471JX	T	67.3/96.9
R486	7410001150	S.ARR EXB28V471JX	T	64.8/105.4
R487	7410001150	S.ARR EXB28V471JX	T	72.8/105.4
R488	7030008400	S.RES ERJ2GEJ 182 X (1.8K)	T	9.5/54.9
R489	7030004980	S.RES ERJ2GEJ 101 X (100)	B	24.1/58.7
R490	7030008290	S.RES ERJ2GEJ 183 X (18K)	B	28.2/58.4
R491	7030004980	S.RES ERJ2GEJ 101 X (100)	B	26.1/51.2
R492	7030005240	S.RES ERJ2GEJ 473 X (47K)	B	29.8/58.8
R493	7030010040	S.RES ERJ2GEJ-JPW	T	11.3/19
R494	7030005000	S.RES ERJ2GEJ 471 X (470)	T	73.2/98.2
R495	7030005100	S.RES ERJ2GEJ 154 X (150K)	T	55.2/55.3
R496	7030005070	S.RES ERJ2GEJ 683 X (68K)	T	52.7/56.2
R497	7030005700	S.RES ERJ2GEJ 274 X (270K)	T	52.7/55.3
R498	7030005600	S.RES ERJ2GEJ 273 X (27K)	B	61.4/103.1
R499	7030004980	S.RES ERJ2GEJ 101 X (100)	T	24.4/57
R500	7030005600	S.RES ERJ2GEJ 273 X (27K)	T	21.2/57.5
R501	7030005220	S.RES ERJ2GEJ 223 X (22K)	T	22.8/53.8
R502	7030005090	S.RES ERJ2GEJ 104 X (100K)	T	28/55
R503	7030007350	S.RES ERJ2GEJ 393 X (39K)	T	55.5/58.4
R505	7030010040	S.RES ERJ2GEJ-JPW	T	113.4/18.3
R506	7030005110	S.RES ERJ2GEJ 224 X (220K)	T	113.4/19.3
R507	7030005090	S.RES ERJ2GEJ 104 X (100K)	T	115/19.3
R508	7030010040	S.RES ERJ2GEJ-JPW	T	144.6/119.6
R509	7030005050	S.RES ERJ2GEJ 103 X (10K)	B	33.3/15.2
R510	7030007350	S.RES ERJ2GEJ 393 X (39K)	B	29/14.1
R511	7030005050	S.RES ERJ2GEJ 103 X (10K)	B	29.1/18.5
R512	7030005050	S.RES ERJ2GEJ 103 X (10K)	B	30.8/18.5
R513	7030007280	S.RES ERJ2GEJ 331 X (330)	B	72.3/90.4
R530	7030005240	S.RES ERJ2GEJ 473 X (47K)	T	62.5/66.3
R531	7030007290	S.RES ERJ2GEJ 222 X (2.2K)	B	64.6/78.2
R532	7030005000	S.RES ERJ2GEJ 471 X (470)	B	45.1/37.1
R533	7030005090	S.RES ERJ2GEJ 104 X (100K)	T	57.2/18.4
R534	7030005600	S.RES ERJ2GEJ 273 X (27K)	B	45.3/58.6
R535	7030004980	S.RES ERJ2GEJ 101 X (100)	B	55.8/55.3
R536	7030005600	S.RES ERJ2GEJ 273 X (27K)	B	55.8/58.6
R537	7030010040	S.RES ERJ2GEJ-JPW	B	41.6/41.2
R539	7030005100	S.RES ERJ2GEJ 154 X (150K)	T	64.2/71.2
R540	7030005090	S.RES ERJ2GEJ 104 X (100K)	T	90.6/17.9
R541	7030005220	S.RES ERJ2GEJ 223 X (22K)	T	28.9/55
R542	7030005110	S.RES ERJ2GEJ 224 X (220K)	B	39.9/72.7
R543	7030005080	S.RES ERJ2GEJ 823 X (82K)	B	40.8/71.1
C1	4030017420	S.CER ECJ0EC1H470J	B	120.7/39
C2	4030017420	S.CER ECJ0EC1H470J	B	22.9/78.1
C3	4030016930	S.CER ECJ0EB1A104K	B	130.8/50.2
C4	4030017420	S.CER ECJ0EC1H470J	B	122.2/37.1
C5	4030017420	S.CER ECJ0EC1H470J	B	21.7/77.1
C6	4030016930	S.CER ECJ0EB1A104K	B	52.4/77.9
C7	4030017420	S.CER ECJ0EC1H470J	B	123.1/37.1
C8	4030017420	S.CER ECJ0EC1H470J	B	21.7/75.5
C9	4030017460	S.CER ECJ0EB1E102K	T	17.6/59
C10	4030016930	S.CER ECJ0EB1A104K	B	55.7/77.9
C11	4030016930	S.CER ECJ0EB1A104K	B	124/37.1
C12	4030016930	S.CER ECJ0EB1A104K	B	22.1/74.3
C13	4030016930	S.CER ECJ0EB1A104K	B	55.6/80.7
C14	4030017460	S.CER ECJ0EB1E102K	T	16.1/59.9
C15	4030016930	S.CER ECJ0EB1A104K	T	62.4/67.5
C16	4030017420	S.CER ECJ0EC1H470J	T	56.2/64.5
C17	4030016930	S.CER ECJ0EB1A104K	B	115.6/40.6
C18	4030017700	S.CER ECJ0EC1H151J	T	62.4/71.2
C19	4030016930	S.CER ECJ0EB1A104K	B	22.9/80.3
C20	4550006250	S.TAN TEESVA 1A 106M8R	B	115.4/37.5
C21	4550006250	S.TAN TEESVA 1A 106M8R	B	21.3/80.5
C22	4030016930	S.CER ECJ0EB1A104K	B	50/77.9
C23	4030016930	S.CER ECJ0EB1A104K	T	57.8/52.6
C24	4030016930	S.CER ECJ0EB1A104K	B	50.3/81.1
C25	4030016930	S.CER ECJ0EB1A104K	B	54.4/81.1
C26	4030017460	S.CER ECJ0EB1E102K	B	117.8/39.2
C27	4030017460	S.CER ECJ0EB1E102K	B	23.8/80.3
C28	4030016930	S.CER ECJ0EB1A104K	B	53.3/77.9
C30	4030017460	S.CER ECJ0EB1E102K	T	59.8/67
C31	4030016930	S.CER ECJ0EB1A104K	T	60.5/53

[MAIN UNIT]

REF NO.	ORDER NO.	DESCRIPTION	M.	H/V LOCATION
C32	4030017590	S.CER ECJ0EC1H070C	B	38.4/79.1
C33	4030016930	S.CER ECJ0EB1A104K	T	58.9/67
C34	4030017570	S.CER ECJ0EC1H040B	B	37.2/78.7
C35	4030016930	S.CER ECJ0EB1A104K	B	38.3/76
C36	4030017500	S.CER ECJ0EC1H560J	B	37.2/79.6
C37	4030016930	S.CER ECJ0EB1A104K	B	48.4/79.8
C38	4030016930	S.CER ECJ0EB1A104K	B	69.8/78.2
C39	4030017360	S.CER ECJ0EC1H030B	B	71.4/77.3
C40	4030017760	S.CER ECJ0EB1H222K	B	68.2/77.3
C41	4030018860	S.CER ECJ0EB0J105K	B	31/58.2
C42	4030017760	S.CER ECJ0EB1H222K	B	68.2/76.4
C43	4030016930	S.CER ECJ0EB1A104K	B	55.6/49
C44	4030018860	S.CER ECJ0EB0J105K	B	35.7/56.4
C45	4030016950	S.CER ECJ0EB1A473K	B	34.5/55.2
C47	4030017460	S.CER ECJ0EB1E102K	B	64.6/77.3
C48	4030016930	S.CER ECJ0EB1A104K	T	52.7/54.4
C49	4030018860	S.CER ECJ0EB0J105K	B	15.6/58.3
C50	4030016930	S.CER ECJ0EB1A104K	B	130.8/48.4
C51	4030017620	S.CER ECJ0EC1H100C	B	125.1/45.3
C52	4030017420	S.CER ECJ0EC1H470J	B	120.6/48.8
C53	4030017420	S.CER ECJ0EC1H470J	B	32.7/78.4
C54	4030017660	S.CER ECJ0EC1H330J	B	32.7/77.3
C56	4030016950	S.CER ECJ0EB1A473K	B	31.9/59.1
C59	4030017430	S.CER ECJ0EC1H101J	B	32.7/76.4
C60	4030017620	S.CER ECJ0EC1H100C	B	32.3/72.9
C61	4030018900	S.CER ECJ0EB0J474K	B	18/63.8
C62	4030016930	S.CER ECJ0EB1A104K	B	33.6/55.2
C63	4030016930	S.CER ECJ0EB1A104K	T	55.5/61.6
C66	4030017430	S.CER ECJ0EC1H101J	B	123.5/48.4
C67	4030017460	S.CER ECJ0EB1E102K	B	67.5/87.7
C69	4030016930	S.CER ECJ0EB1A104K	B	29.8/63
C70	4030017460	S.CER ECJ0EB1E102K	B	64.3/79.4
C71	4030016930	S.CER ECJ0EB1A104K	B	57.6/43.3
C72	4030018910	S.CER C1608 JB 0J 475K-T	B	29.3/61.9
C73	4030017460	S.CER ECJ0EB1E102K	B	96.3/45.4
C75	4030017460	S.CER ECJ0EB1E102K	B	36/105.6
C77	4030016930	S.CER ECJ0EB1A104K	T	53.9/57.7
C78	4030017460	S.CER ECJ0EB1E102K	B	119.7/50.4
C79	4030017460	S.CER ECJ0EB1E102K	B	34.3/79.5
C80	4030017350	S.CER ECJ0EC1H020B	[USA-01] [EXP-01]	B 102.4/45.6
	4030017350	S.CER ECJ0EC1H020B	[USA-02] [EXP-02]	
	4030017550	S.CER ECJ0EC1H1R5B	[EXP-02]	
	4030017350	S.CER ECJ0EC1H020B	[EUR-01]	
C81	4030017350	S.CER ECJ0EC1H020B	[USA-01]	B 42.2/99.6
	4030017350	S.CER ECJ0EC1H020B	[EXP-01]	
	4030017550	S.CER ECJ0EC1H1R5B	[USA-02]	
	4030017550	S.CER ECJ0EC1H1R5B	[EXP-02]	
	4030017350	S.CER ECJ0EC1H020B	[EUR-01]	
C82	4550006250	S.TAN TEESVA 1A 106M8R	B	61.1/79.2
C83	4030017460	S.CER ECJ0EB1E102K	B	71.7/86.7
C84	4030017420	S.CER ECJ0EC1H470J	B	74.7/81.1
C85	4030017590	S.CER ECJ0EC1H070C	B	56/43.3
C86	4030016930	S.CER ECJ0EB1A104K	B	51.7/47.1
C87	4030018910	S.CER C1608 JB 0J 475K-T	B	54.3/48.4
C88	4030017770	S.CER ECJ0EB1E332K	B	86.7/40.6
C89	4030017770	S.CER ECJ0EB1E332K	B	28/99.3
C90	4030017680	S.CER ECJ0EC1H820J	B	69.1/86.7
C91	4030016930	S.CER ECJ0EB1A104K	T	60.7/66.3
C92	4030017690	S.CER ECJ0EB1C103K	B	72.7/88
C93	4030017460	S.CER ECJ0EB1E102K	B	70/87.9
C96	4030018910	S.CER C1608 JB 0J 475K-T	B	49.2/48.9
C97	4030016930	S.CER ECJ0EB1A104K	B	57.4/50.6
C98	4030017460	S.CER ECJ0EB1E102K	B	35.1/107.3
C99	4030017460	S.CER ECJ0EB1E102K	B	40.8/72.7
C101	4030017620	S.CER ECJ0EC1H100C	B	37.7/63.2
C102	4550000560	S.TAN TEESVA 1V 334M8R	B	84.7/42.7
C103	4550003260	S.TAN TEESVA 1V 684M8R	B	26.2/100.4
C104	4030016930	S.CER ECJ0EB1A104K	B	39.9/74.5
C105	4030017520	S.CER ECJ0EC1H0R3B	B	103.2/47.8
C106	4030017340	S.CER ECJ0EC1H010B	B	47/100.1
C107	4030017590	S.CER ECJ0EC1H070C	B	72.3/89.5
C108	4030017460	S.CER ECJ0EB1E102K	B	94.5/47.1
C109	4030017530	S.CER ECJ0EC1H0R5B	B	101.9/48.3
C110	4030017530	S.CER ECJ0EC1H0R5B	B	46.5/101.4
C111	4030016790	S.CER ECJ0EB1C103K	B	70.7/92.3
C112	4550000270	S.TAN TEESVA 1E 474M8R	B	84.7/47.9
C113	4550000270	S.TAN TEESVA 1E 474M8R	B	26.2/105.6
C114	4030017520	S.CER ECJ0EC1H0R3B	B	103.2/49.6
C115	4030017550	S.CER ECJ0EC1H1R5B	[USA-01] [EXP-01]	B 47/102.8
	4030017550	S.CER ECJ0EC1H1R5B	[USA-02] [EXP-02]	
	4030017340	S.CER ECJ0EC1H010B	[EXP-02]	
	4030017550	S.CER ECJ0EC1H1R5B	[EUR-01]	
C116	4030017460	S.CER ECJ0EB1E102K	B	70.7/89.5
C117	4030016790	S.CER ECJ0EB1C103K	B	69.1/90.4
C118	4030016790	S.CER ECJ0EB1C103K	B	69.1/91.3
C121	4030016790	S.CER ECJ0EB1C103K	B	71.1/94.8
C122				

[MAIN UNIT]

REF NO.	ORDER NO.	DESCRIPTION	M.	H/V LOCATION
C145	4030017420	S.CER ECJ0EC1H470J	B	50.4/38.5
C146	4030017460	S.CER ECJ0EB1E102K	B	56.2/35.1
C147	4550006250	S.TAN TEESVA 1A 106M8R	B	33.3/100.4
C149	4030016790	S.CER ECJ0EB1C103K	B	69.4/95.7
C150	4030016790	S.CER ECJ0EB1C103K	B	65.7/97.3
C151	4030017610	S.CER ECJ0EC1H090C	B	61.7/97.1
C152	4030016930	S.CER ECJ0EB1A104K	B	55.3/32.4
C153	4030017380	S.CER ECJ0EC1H050B	B	49.8/34.9
C154	4030017420	S.CER ECJ0EC1H470J	B	26.5/120.6
C155	4030017460	S.CER ECJ0EB1E102K	B	26.5/123.2
C156	4030017420	S.CER ECJ0EC1H470J	B	28.5/111.5
C157	4030017460	S.CER ECJ0EB1E102K	B	28/117.2
C158	4030017420	S.CER ECJ0EC1H470J	B	81.7/62.1
C159	4030017420	S.CER ECJ0EC1H470J	B	81.7/53.6
C160	4030016790	S.CER ECJ0EB1C103K	B	65.7/104.4
C161	4030016790	S.CER ECJ0EB1C103K	B	62.7/98.9
C162	4030016930	S.CER ECJ0EB1A104K	B	81.7/67.1
C163	4030016930	S.CER ECJ0EB1A104K	B	81.7/58.6
C164	4030016930	S.CER ECJ0EB1A104K	B	49.5/36.8
C165	4030017460	S.CER ECJ0EB1E102K	B	81.7/66.2
C166	4030017460	S.CER ECJ0EB1E102K	B	81.7/57.7
C167	4030017460	S.CER ECJ0EB1E102K	B	97.3/45.4
C168	4030017380	S.CER ECJ0EC1H050B	B	32.6/124.3
C169	4030017620	S.CER ECJ0EC1H100C [USA-01]	B	30.8/124.4
	4030017620	S.CER ECJ0EC1H100C [EXP-01]		
	4030017570	S.CER ECJ0EC1H040B [USA-02]		
	4030017570	S.CER ECJ0EC1H040B [EXP-02]		
	4030017620	S.CER ECJ0EC1H100C [EUR-01]		
C170	4030017580	S.CER ECJ0EC1H060C	B	30.6/114.4
C171	4030017630	S.CER ECJ0EC1H120J [USA-01]	B	30.6/115.3
	4030017630	S.CER ECJ0EC1H120J [EXP-01]		
	4030017380	S.CER ECJ0EC1H050B [USA-02]		
	4030017380	S.CER ECJ0EC1H050B [EXP-02]		
	4030017630	S.CER ECJ0EC1H120J [EUR-01]		
C172	4030017580	S.CER ECJ0EC1H060C [USA-01]	B	87.8/65.7
	4030017580	S.CER ECJ0EC1H060C [EXP-01]		
	4030017570	S.CER ECJ0EC1H040B [USA-02]		
	4030017570	S.CER ECJ0EC1H040B [EXP-02]		
	4030017580	S.CER ECJ0EC1H060C [EUR-01]		
C173	4030017630	S.CER ECJ0EC1H120J [USA-01]	B	86.5/65.3
	4030017630	S.CER ECJ0EC1H120J [EXP-01]		
	4030017620	S.CER ECJ0EC1H100C [USA-02]		
	4030017620	S.CER ECJ0EC1H100C [EXP-02]		
	4030017630	S.CER ECJ0EC1H120J [EUR-01]		
C174	4030017590	S.CER ECJ0EC1H070C [USA-01]	B	85.7/55
	4030017590	S.CER ECJ0EC1H070C [EXP-01]		
	4030017580	S.CER ECJ0EC1H060C [USA-02]		
	4030017580	S.CER ECJ0EC1H060C [EXP-02]		
	4030017590	S.CER ECJ0EC1H070C [EUR-01]		
C175	4030017390	S.CER ECJ0EC1H180J [USA-01]	B	85.7/55.9
	4030017390	S.CER ECJ0EC1H180J [EXP-01]		
	4030017590	S.CER ECJ0EC1H070C [USA-02]		
	4030017590	S.CER ECJ0EC1H070C [EXP-02]		
	4030017390	S.CER ECJ0EC1H180J [EUR-01]		
C176	4030018860	S.CER ECJ0EB0J105K	T	62.9/51
C177	4030017380	S.CER ECJ0EC1H050B [USA-01]	B	35.6/120.7
	4030017380	S.CER ECJ0EC1H050B [EXP-01]		
	4030017350	S.CER ECJ0EC1H020B [USA-02]		
	4030017350	S.CER ECJ0EC1H020B [EXP-02]		
	4030017380	S.CER ECJ0EC1H050B [EUR-01]		
C178	4030017580	S.CER ECJ0EC1H060C [USA-01]	B	32/112.2
	4030017580	S.CER ECJ0EC1H060C [EXP-01]		
	4030017360	S.CER ECJ0EC1H030B [USA-02]		
	4030017360	S.CER ECJ0EC1H030B [EXP-02]		
	4030017580	S.CER ECJ0EC1H060C [EUR-01]		
C179	4030017420	S.CER ECJ0EC1H470J	T	14.9/129.1
C180	4030017600	S.CER ECJ0EC1H080C [USA-01]	B	91.5/62
	4030017600	S.CER ECJ0EC1H080C [EXP-01]		
	4030017570	S.CER ECJ0EC1H040B [USA-02]		
	4030017570	S.CER ECJ0EC1H040B [EXP-02]		
	4030017600	S.CER ECJ0EC1H080C [EUR-01]		
C181	4030017590	S.CER ECJ0EC1H070C [USA-01]	B	87.1/52.9
	4030017590	S.CER ECJ0EC1H070C [EXP-01]		
	4030017380	S.CER ECJ0EC1H050B [USA-02]		
	4030017380	S.CER ECJ0EC1H050B [EXP-02]		
	4030017590	S.CER ECJ0EC1H070C [EUR-01]		
C182	4030016790	S.CER ECJ0EB1C103K	B	63.1/104.4
C183	4030017420	S.CER ECJ0EC1H470J	T	14.9/131.3
C184	4030017620	S.CER ECJ0EC1H100C	B	34.9/124.3
C185	4030017630	S.CER ECJ0EC1H120J [USA-01]	B	35.4/115.3
	4030017630	S.CER ECJ0EC1H120J [EXP-01]		
	4030017610	S.CER ECJ0EC1H090C [USA-02]		
	4030017610	S.CER ECJ0EC1H090C [EXP-02]		
	4030017630	S.CER ECJ0EC1H120J [EUR-01]		
C186	4030017420	S.CER ECJ0EC1H470J	B	98.2/48.8
C187	4030017540	S.CER ECJ0EC1HR75B [USA-01]	B	89.4/66.8
	4030017540	S.CER ECJ0EC1HR75B [EXP-01]		
	4030017530	S.CER ECJ0EC1H0R5B [USA-02]		
	4030017530	S.CER ECJ0EC1H0R5B [EXP-02]		
	4030017540	S.CER ECJ0EC1HR75B [EUR-01]		
C188	4030017360	S.CER ECJ0EC1H030B	B	90.6/66.6
C189	4030017340	S.CER ECJ0EC1H010B	B	87/57.2
C190	4030017350	S.CER ECJ0EC1H020B [USA-01]	B	87/58.2
	4030017350	S.CER ECJ0EC1H020B [EXP-01]		
	4030017340	S.CER ECJ0EC1H010B [USA-02]		
	4030017340	S.CER ECJ0EC1H010B [EXP-02]		
	4030017350	S.CER ECJ0EC1H020B [EUR-01]		
C191	4030017380	S.CER ECJ0EC1H050B [USA-01]	B	89.4/65.7
	4030017380	S.CER ECJ0EC1H050B [EXP-01]		
	4030017640	S.CER ECJ0EC1H150J [USA-02]		
	4030017640	S.CER ECJ0EC1H150J [EXP-02]		
	4030017380	S.CER ECJ0EC1H050B [EUR-01]		

[MAIN UNIT]

REF NO.	ORDER NO.	DESCRIPTION	M.	H/V LOCATION
C192	4030017640	S.CER ECJ0EC1H150J [USA-01]	B	90.5/56.3
	4030017640	S.CER ECJ0EC1H150J [EXP-01]		
	4030017600	S.CER ECJ0EC1H080C [USA-02]		
	4030017600	S.CER ECJ0EC1H080C [EXP-02]		
	4030017640	S.CER ECJ0EC1H150J [EUR-01]		
C193	4030017460	S.CER ECJ0EB1E102K	B	61.4/107.1
C194	4030017580	S.CER ECJ0EC1H060C [USA-01]	B	36.8/122.8
	4030017580	S.CER ECJ0EC1H060C [EXP-01]		
	4030017600	S.CER ECJ0EC1H080C [USA-02]		
	4030017600	S.CER ECJ0EC1H080C [EXP-02]		
	4030017580	S.CER ECJ0EC1H060C [EUR-01]		
C195	4030017630	S.CER ECJ0EC1H120J	B	40.1/120.7
C196	4030017620	S.CER ECJ0EC1H100C	B	37.6/114.4
C197	4030017640	S.CER ECJ0EC1H150J	B	41/112.2
C198	4030016790	S.CER ECJ0EB1C103K	B	60.5/107.1
C200	4030017570	S.CER ECJ0EC1H040B	B	92.4/64.3
C201	4030017620	S.CER ECJ0EC1H100C	B	96/62
C202	4030017610	S.CER ECJ0EC1H090C	B	93.1/55.4
C203	4030017390	S.CER ECJ0EC1H180J	B	96.3/52.9
C204	4550006250	S.TAN TEESVA 1A 106M8R	T	81.7/17
C205	4550006250	S.TAN TEESVA 1A 106M8R	T	85.1/17
C206	4550006250	S.TAN TEESVA 1A 106M8R	T	88.8/16.7
C208	4030017490	S.CER C1608 JB 1A 105K-T	T	80/16.6
C209	4030017490	S.CER C1608 JB 1A 105K-T	T	83.4/16.6
C210	4030017490	S.CER C1608 JB 1A 105K-T	T	86.9/16.3
C211	4030016930	S.CER ECJ0EB1A104K	B	38.3/120.7
C212	4030016790	S.CER ECJ0EB1C103K	B	39.2/112.2
C213	4030017660	S.CER ECJ0EC1H330J	B	68.5/106.1
C214	4030017460	S.CER ECJ0EB1E102K	B	66.8/107
C215	4030017530	S.CER ECJ0EC1HOR5B	B	41.9/120.7
C216	4030017520	S.CER ECJ0EC1HOR3B	B	42.6/115.7
C217	4030017460	S.CER ECJ0EB1E102K	B	39.2/120.7
C218	4030017460	S.CER ECJ0EB1E102K	B	40.1/112.2
C219	4030016790	S.CER ECJ0EB1C103K	B	94.2/62
C220	4030017530	S.CER ECJ0EC1HOR5B	B	98.2/61.3
C221	4030016790	S.CER ECJ0EB1C103K	B	94.5/52.9
C222	4030017530	S.CER ECJ0EC1HOR5B	B	98.2/57.1
C224	4030017460	S.CER ECJ0EB1E102K	B	95.1/62
C225	4030017460	S.CER ECJ0EB1E102K	B	95.4/52.9
C228	4030017490	S.CER C1608 JB 1A 105K-T	T	79.8/24.4
C229	4030017490	S.CER C1608 JB 1A 105K-T	T	83.3/24.4
C230	4030017490	S.CER C1608 JB 1A 105K-T	T	86.8/24.4
C231	4550005980	S.TAN TEESVA 1A 475M8R	T	81.6/25.6
C232	4550005980	S.TAN TEESVA 1A 475M8R	T	85.1/25.6
C233	4550005980	S.TAN TEESVA 1A 475M8R	T	88.5/25.6
C235	4030017030	S.CER ECJ0EB1A273K	T	41/55
C236	4030017730	S.CER ECJ0EB1E471K	B	100.5/55
C237	4030017460	S.CER ECJ0EB1E102K	B	100.5/60.4
C238	4030017730	S.CER ECJ0EB1E471K	B	44.9/112.6
C239	4030017460	S.CER ECJ0EB1E102K	B	44.9/118
C240	4510008540	S.ELF EEE1CA100SR	T	95.1/22.3
C241	4030017350	S.CER ECJ0EC1H020B	B	68.3/120.9
C242	4030016790	S.CER ECJ0EB1C103K	B	68.7/111.2
C243	4030017460	S.CER ECJ0EB1E102K	B	70.3/106.1
C244	4030016790	S.CER ECJ0EB1C103K	B	70.3/107
C245	4030017460	S.CER ECJ0EB1E102K	B	91.5/59.6
C246	4030017580	S.CER ECJ0EC1H060C	B	46.9/113.5
C247	4030017460	S.CER ECJ0EB1E102K	B	43.1/109.1
C248	4030017460	S.CER ECJ0EB1E102K	B	36/117.8
C249	4030017420	S.CER ECJ0EC1H470J	B	48.1/109.1
C250	4030017380	S.CER ECJ0EC1H050B	B	103.7/58.7
C251	4030017580	S.CER ECJ0EC1H060C [USA-01]	B	102.6/55.9
	4030017580	S.CER ECJ0EC1H060C [EXP-01]		
	4030017600	S.CER ECJ0EC1H080C [USA-02]		
	4030017600	S.CER ECJ0EC1H080C [EXP-02]		
	4030017580	S.CER ECJ0EC1H060C [EUR-01]		
C252	4030017460	S.CER ECJ0EB1E102K	B	100.5/50
C253	4030017380	S.CER ECJ0EC1H050B	B	48/116.2
C254	4030017460	S.CER ECJ0EB1E102K	B	103.7/53.4
C255	4030016930	S.CER ECJ0EB1A104K	T	42.1/50.6
C256	4030017640	S.CER ECJ0EC1H150J	T	43.1/55
C257	4030016790	S.CER ECJ0EB1C103K	T	34.5/58.8
C258	4030017580	S.CER ECJ0EC1H060C [USA-01]	B	59.6/117.8
	4030017580	S.CER ECJ0EC1H060C [EXP-01]		
	4030017620	S.CER ECJ0EC1H100C [USA-02]		
	4030017620	S.CER ECJ0EC1H100C [EXP-02]		
	4030017580	S.CER ECJ0EC1H060C [EUR-01]		
C259	4030017580	S.CER ECJ0EC1H060C	T	48.5/46.4
C260	4030017460	S.CER ECJ0EB1E102K	B	46.5/105.4
C262	4030016930	S.CER ECJ0EB1A104K	T	69.2/57.5
C263	4030017420	S.CER ECJ0EC1H470J	B	60.5/126.1
C264	4030017460	S.CER ECJ0EB1E102K	B	101.9/50
C265	4030017460	S.CER ECJ0EB1E102K	B	43.5/120.7
C266	4030018900	S.CER ECJ0EB0J474K	T	43.9/45.6
C267	4030017630	S.CER ECJ0EC1H120J [USA-01]	B	59.6/119.3
	4030017630	S.CER ECJ0EC1H120J [EXP-01]		
	4030017390	S.CER ECJ0EC1H180J [USA-02]		
	4030017390	S.CER ECJ0EC1H180J [EXP-02]		
	4030017630	S.CER ECJ0EC1H120J [EUR-01]		
C268	4030017420	S.CER ECJ0EC1H470J	B	62.3/126.1
C269	4550006780	S.TAN TEESVB2 0J 476M8R	T	71.8/60.8
C270	4030016930	S.CER ECJ0EB1A104K	T	40.5/49.7
C271	4030017350	S.CER ECJ0EC1H020B	B	68.1/137.9
C272	4030017630	S.CER ECJ0EC1H120J	T	47.3/60.1
C274	4030017460	S.CER ECJ0EB1E102K	B	44.4/120.7
C275	4030017620	S.CER ECJ0EC1H100C [USA-01]	B	48/124.4
	4030017620			

[MAIN UNIT]

REF NO.	ORDER NO.	DESCRIPTION	M.	H/V LOCATION
C279	4030017580	S.CER ECJ0EC1H060C [USA-01]	B	59.6/120.9
	4030017580	S.CER ECJ0EC1H060C [EXP-01]		
	4030017620	S.CER ECJ0EC1H100C [USA-02]		
	4030017620	S.CER ECJ0EC1H100C [EXP-02]		
	4030017580	S.CER ECJ0EC1H060C [EUR-01]		
C280	4030017460	S.CER ECJ0EB1E102K	B	98.9/66.3
C281	4030017460	S.CER ECJ0EB1E102K	B	100/62
C282	4030017620	S.CER ECJ0EC1H100C [USA-01]	B	61.4/122.2
	4030017620	S.CER ECJ0EC1H100C [EXP-01]		
	4030017580	S.CER ECJ0EC1H060C [USA-02]		
	4030017580	S.CER ECJ0EC1H060C [EXP-02]		
	4030017620	S.CER ECJ0EC1H100C [EUR-01]		
C283	4030017620	S.CER ECJ0EC1H100C	B	103.7/65.9
C285	4030017620	S.CER ECJ0EC1H100C [USA-01]	B	66.1/137.9
	4030017620	S.CER ECJ0EC1H100C [EXP-01]		
	4030017580	S.CER ECJ0EC1H060C [USA-02]		
	4030017580	S.CER ECJ0EC1H060C [EXP-02]		
	4030017620	S.CER ECJ0EC1H100C [EUR-01]		
C286	4030017530	S.CER ECJ0EC1H0R5B	B	64.5/139.2
C287	4030017350	S.CER ECJ0EC1H020B [USA-01]	B	61.8/134.7
	4030017350	S.CER ECJ0EC1H020B [EXP-01]		
	4030017550	S.CER ECJ0EC1H1R5B [USA-02]		
	4030017550	S.CER ECJ0EC1H1R5B [EXP-02]		
	4030017350	S.CER ECJ0EC1H020B [EUR-01]		
C291	4030017340	S.CER ECJ0EC1H010B [USA-01]	B	102.4/66.6
	4030017340	S.CER ECJ0EC1H010B [EXP-01]		
	4030017340	S.CER ECJ0EC1H010B [EUR-01]		
C292	4030017460	S.CER ECJ0EB1E102K	B	65/136.3
C293	4030017620	S.CER ECJ0EC1H100C [USA-01]	B	62.9/137.9
	4030017620	S.CER ECJ0EC1H100C [EXP-01]		
	4030017580	S.CER ECJ0EC1H060C [USA-02]		
	4030017580	S.CER ECJ0EC1H060C [EXP-02]		
	4030017620	S.CER ECJ0EC1H100C [EUR-01]		
C294	4030017530	S.CER ECJ0EC1H0R5B	B	58.3/138.5
C295	4030017460	S.CER ECJ0EB1E102K	B	65/134.7
C296	4030017620	S.CER ECJ0EC1H100C [USA-01]	B	56.1/138
	4030017620	S.CER ECJ0EC1H100C [EXP-01]		
	4030017580	S.CER ECJ0EC1H060C [USA-02]		
	4030017580	S.CER ECJ0EC1H060C [EXP-02]		
	4030017620	S.CER ECJ0EC1H100C [EUR-01]		
C298	4030017460	S.CER ECJ0EB1E102K	B	136.2/82.9
C299	4030017460	S.CER ECJ0EB1E102K	B	50.4/133.8
C300	4030017460	S.CER ECJ0EB1E102K	B	54.1/133.9
C301	4030016790	S.CER ECJ0EB1C103K	B	51.4/133.8
C302	4030017460	S.CER ECJ0EB1E102K	B	52/138.5
C303	4030017370	S.CER ECJ0EC1H3R5B	B	131.4/82.3
C304	4030017420	S.CER ECJ0EC1H470J	B	136.2/81.9
C305	4030017420	S.CER ECJ0EC1H470J	B	46.4/133.8
C306	4030017460	S.CER ECJ0EB1E102K	B	47.4/133.8
C307	4030017460	S.CER ECJ0EB1E102K	B	45.4/138.3
C309	4030017420	S.CER ECJ0EC1H470J	B	136.8/84.5
C310	4030017380	S.CER ECJ0EC1H050B [USA-01]	B	134.9/85.9
	4030017380	S.CER ECJ0EC1H050B [EXP-01]		
	4030017370	S.CER ECJ0EC1H3R5B [USA-02]		
	4030017370	S.CER ECJ0EC1H3R5B [EXP-02]		
	4030017380	S.CER ECJ0EC1H050B [EUR-01]		
C311	4030016930	S.CER ECJ0EB1A104K	B	45.4/140.4
C312	4030017420	S.CER ECJ0EC1H470J	B	50.4/140.4
C313	4030016930	S.CER ECJ0EB1A104K	B	46.4/140.4
C314	4030017460	S.CER ECJ0EB1E102K	B	49.4/140.4
C315	4030017730	S.CER ECJ0EB1E472K	B	137.8/84.5
C316	4030017570	S.CER ECJ0EC1H040B	B	130.4/80.9
C321	4030017420	S.CER ECJ0EC1H470J	T	66/57.5
C322	4030017420	S.CER ECJ0EC1H470J	T	67.6/54.3
C323	4030017620	S.CER ECJ0EC1H100C	B	44.4/137.7
C324	4030017530	S.CER ECJ0EC1H0R5B [USA-01]	B	134.9/88.3
	4030017530	S.CER ECJ0EC1H0R5B [EXP-01]		
	4030017520	S.CER ECJ0EC1H0R3B [USA-02]		
	4030017520	S.CER ECJ0EC1H0R3B [EXP-02]		
	4030017530	S.CER ECJ0EC1H0R5B [EUR-01]		
C326	4030017580	S.CER ECJ0EC1H060C [USA-01]	B	39.3/138.2
	4030017580	S.CER ECJ0EC1H060C [EXP-01]		
	4030017590	S.CER ECJ0EC1H070C [USA-02]		
	4030017590	S.CER ECJ0EC1H070C [EXP-02]		
	4030017580	S.CER ECJ0EC1H060C [EUR-01]		
C327	4030017360	S.CER ECJ0EC1H030B [USA-01]	B	141.8/89.2
	4030017360	S.CER ECJ0EC1H030B [EXP-01]		
	4030017360	S.CER ECJ0EC1H030B [USA-02]		
	4030017360	S.CER ECJ0EC1H030B [EXP-02]		
	4030017350	S.CER ECJ0EC1H020B [EUR-01]		
C328	4030017420	S.CER ECJ0EC1H470J	B	140.9/85.4
C329	4030017410	S.CER ECJ0EC1H240J [USA-01]	B	38.4/133.5
	4030017410	S.CER ECJ0EC1H240J [EXP-01]		
	4030017390	S.CER ECJ0EC1H180J [USA-02]		
	4030017390	S.CER ECJ0EC1H180J [EXP-02]		
	4030017410	S.CER ECJ0EC1H240J [EUR-01]		
C330	4030017460	S.CER ECJ0EB1E102K	B	139.9/85.4
C331	4030017460	S.CER ECJ0EB1E102K	B	59.2/140.4
C332	4030018860	S.CER ECJ0EB0J105K	B	55/140.4
C333	4030016930	S.CER ECJ0EB1A104K	T	23.1/29.4
C335	4030017550	S.CER ECJ0EC1H1R5B	B	144/89.5
C336	4030018860	S.CER ECJ0EB0J105K	B	60.1/140.4
C337	4030017580	S.CER ECJ0EC1H060C	B	142.6/91.7
C338	4030017550	S.CER ECJ0EC1H1R5B	B	39.3/139.1
C339	4030017460	S.CER ECJ0EB1E102K	B	32.5/134
C340	4030016930	S.CER ECJ0EB1A104K	T	54/20.3
C341	4030017420	S.CER ECJ0EC1H470J	T	143.1/123.3
C342	4030017730	S.CER ECJ0EB1E472K	T	138.8/108
C345	4030017460	S.CER ECJ0EB1E102K	B	30.6/135.9
C346	4030017420	S.CER ECJ0EC1H470J	T	63.1/57.2
C347	4030017460	S.CER ECJ0EB1E102K	T	143.1/124.2
C348	4030017420	S.CER ECJ0EC1H470J	T	63.8/55.2
C349	4030017580	S.CER ECJ0EC1H060C	B	143.5/95.2
C350	4030017420	S.CER ECJ0EC1H470J	T	138.7/112.3

[MAIN UNIT]

REF NO.	ORDER NO.	DESCRIPTION	M.	H/V LOCATION
C351	4030017460	S.CER ECJ0EB1E102K	T	138.7/113.2
C352	4030017410	S.CER ECJ0EC1H240J [USA-01]	B	31.6/137.9
	4030017410	S.CER ECJ0EC1H240J [EXP-01]		
	4030017390	S.CER ECJ0EC1H180J [USA-02]		
	4030017390	S.CER ECJ0EC1H180J [EXP-02]		
	4030017410	S.CER ECJ0EC1H240J [EUR-01]		
C353	4030017460	S.CER ECJ0EB1E102K	T	140.4/118.8
C354	4030017420	S.CER ECJ0EC1H470J	T	106.6/115.9
C355	4030017580	S.CER ECJ0EC1H060C [USA-01]	B	37.5/136.8
	4030017580	S.CER ECJ0EC1H060C [EXP-01]		
	4030017590	S.CER ECJ0EC1H070C [USA-02]		
	4030017590	S.CER ECJ0EC1H070C [EXP-02]		
	4030017580	S.CER ECJ0EC1H060C [EUR-01]		
C357	4030017630	S.CER ECJ0EC1H120J	B	39.3/140
C358	4030016790	S.CER ECJ0EB1C103K	T	137.5/128.2
C359	4510009550	S.ELE EEEFK1C100R	T	107.2/86.5
C360	4030017460	S.CER ECJ0EB1E102K	T	106.6/116.8
C361	40300011030	S.CER GRM31M4C2H1R5CY21L (GRM42-6 CK) [USA-01] only	B	100.2/115.8
C362	4030017510	S.CER ECJ0EC1H680J	B	39.7/144.6
C364	4030011020	S.CER GRM31M4C2H1R0CY21L (GRM42-6 CK)	B	89.8/119.8
C365	4030017730	S.CER ECJ0EB1E472K	T	106.6/117.7
C366	4030016970	S.CER ECJ0EB1C223K	T	142.4/126.6
C367	4510009810	S.ELE EEEFK1E220R	T	107.3/95.1
C368	4030006860	S.CER C1608 JB 1H 102K-T	T	89.1/142
C369	4030017460	S.CER ECJ0EB1E102K	B	33.4/134
C370	4030011060	S.CER GRM31M2C2H4R0CY21L (GRM42-6 CH) [USA-01]	B	100.2/123.1
	4030011060	S.CER GRM31M2C2H4R0CY21L (GRM42-6 CH) [EXP-01]		
	4030011070	S.CER GRM31M2C2H5R0CY21L (GRM42-6 CH) [EUR-01]		
C371	4030006980	S.CER C1608 CH 1H 070D-T	T	35.5/142.5
C372	4030011100	S.CER GRM31M2C2H8R0DV01L (GRM42-6 CH)	B	100.2/121
C373	4030017780	S.CER ECJ0EB1E472K	T	136.7/123.8
C374	4030017420	S.CER ECJ0EC1H470J	B	85.2/129.8
C375	4030017460	S.CER ECJ0EB1E102K	T	113.1/95.2
C376	4030017350	S.CER ECJ0EC1H020B	B	86/138.8
C377	4030017420	S.CER ECJ0EC1H470J	B	84.2/119.4
C378	4030017420	S.CER ECJ0EC1H470J	T	112.2/95.2
C381	4030017400	S.CER ECJ0EC1H220J	T	111.3/95.2
C383	4030017460	S.CER ECJ0EB1E102K	T	114/78.2
C385	4030017460	S.CER ECJ0EB1E102K	B	22.8/142.4
C386	4030017460	S.CER ECJ0EB1E102K	T	139.2/119.6
C387	4030017600	S.CER ECJ0EC1H080C	B	89.7/137.9
C388	4510009550	S.ELE EEEFK1C100R	T	126.4/77.2
C389	4030019200	S.CER GRM31BR32J102KY01L (GHM1030 R)	B	96.8/130.4
C390	4030011070	S.CER GRM31M2C2H5R0CY21L (GRM42-6 CH)	B	87.6/133.2
C391	4030017460	S.CER ECJ0EB1E102K	T	122.2/76
C392	4030017520	S.CER ECJ0EC1H0R3B	B	95.4/134.3
C393	4030011050	S.CER GRM31M3C2H3R0CY21L (GRM42-6 CJ)	B	98.4/126.8
C394	4550006250	S.TAN TEESVA 1A 106M8R	B	26.3/15.3
C395	4030011050	S.TAN GRM31M3C2H3R0CY21L (GRM42-6 CJ)	B	100.5/126.9
C396	4510009550	S.ELE EEEFK1C100R	T	97/77.8
C397	4030017460	S.CER ECJ0EB1E102K	T	137.4/118.5
C398	4550006250	S.TAN TEESVA 1A 106M8R	B	31.7/15.5
C399	4030017460	S.CER ECJ0EB1E102K	T	100/76.2
C400	4030017460	S.CER ECJ0EB1E102K	B	86.2/129.8
C401	4030011080	S.CER GRM31M2C2H6R0DV01L (GRM42-6 CH)	B	103.2/130.9
C402	4030016930	S.CER ECJ0EB1A104K	T	47.2/71.6
C403	40300011050	S.CER GRM31M3C2H3R0CY21L (GRM42-6 CJ)	B	106.2/130.9
C404	4030017460	S.CER ECJ0EB1E102K	T	140.7/129.2
C405	4030017420	S.CER ECJ0EC1H470J	B	56.7/55.3
C406	4030016790	S.CER ECJ0EB1C103K	T	103.5/76.2
C407	40300011030	S.CER GRM31M4C2H1R5CY21L (GRM42-6 CK)	B	102.6/137.2
C408	4030017460	S.CER ECJ0EB1E102K	B	98.1/138.5
C409	4030011050	S.CER GRM31M3C2H3R0CY21L (GRM42-6 CJ)	B	110.9/136
C410	4030011050	S.CER GRM31M3C2H3R0CY21L (GRM42-6 CJ) [USA-01]	B	113/134
	4030011050	S.CER GRM31M3C2H3R0CY21L (GRM42-6 CJ) [EXP-01]		
	4030011060	S.CER GRM31M2C2H4R0CY21L (GRM42-6 CH) [USA-02]		
	4030011060	S.CER GRM31M2C2H4R0CY21L (GRM42-6 CH) [EXP-02]		
	4030011050	S.CER GRM31M3C2H3R0CY21L (GRM42-6 CJ) [EUR-01]		
C411				



[MAIN UNIT]

REF NO.	ORDER NO.	DESCRIPTION	M.	H/V LOCATION
C419	4030011050	S.CER GRM31M3C2H3R0CY21L (GRM42-6 CJ) [USA-01]	B	115.7/134
	4030011050	S.CER GRM31M3C2H3R0CY21L (GRM42-6 CJ) [EXP-01]		
	4030011050	S.CER GRM31M3C2H3R0CY21L (GRM42-6 CJ) [USA-02]		
	4030011050	S.CER GRM31M3C2H3R0CY21L (GRM42-6 CJ) [EXP-02]		
	4030011080	S.CER GRM31M2C2H6R0DV01L (GRM42-6 CH) [EUR-01]		
C420	4030016930	S.CER ECJ0EB1A104K	B	27.4/18.5
C422	4030006860	S.CER C1608 JB 1H 102K-T	B	119.5/139.5
C423	4030017460	S.CER ECJ0EB1E102K	B	119.4/145.9
C424	4030016930	S.CER ECJ0EB1A104K	T	14.1/125.7
C426	4030009530	S.CER C1608 CH 1H 030B-T [USA-01]	B	120.8/139.5
	4030009530	S.CER C1608 CH 1H 030B-T [EXP-01]		
	4030009530	S.CER C1608 CH 1H 030B-T [USA-02]		
	4030009530	S.CER C1608 CH 1H 030B-T [EXP-02]		
	4030009540	S.CER C1608 CH 1H 1R5B-T [EUR-01]		
C431	4030018860	S.CER ECJ0EB0J105K	B	33.3/13.6
C432	4030016930	S.CER ECJ0EB1A104K	T	10.8/120.6
C433	4030006860	S.CER C1608 JB 1H 102K-T	B	139.5/137.7
C434	4030017460	S.CER ECJ0EB1E102K	B	140.5/131
C435	4030017460	S.CER ECJ0EB1E102K	T	54.8/29.8
C436	4030011050	S.CER GRM31M3C2H3R0CY21L (GRM42-6 CJ) [USA-01]	B	144.8/138.6
	4030011050	S.CER GRM31M3C2H3R0CY21L (GRM42-6 CJ) [EXP-01]		
	4030011050	S.CER GRM31M3C2H3R0CY21L (GRM42-6 CJ) [USA-02]		
	4030011050	S.CER GRM31M3C2H3R0CY21L (GRM42-6 CJ) [EXP-02]		
	4030011040	S.CER GRM31M4C2H2R0CY21L (GRM42-6 CK) [EUR-01]		
C437	4030016930	S.CER ECJ0EB1A104K	B	34.4/12
C438	4030016790	S.CER ECJ0EB1C103K	T	112.8/88.2
C439	4510009810	S.ELE EEEFK1E220R	T	128.4/89.8
C440	4030018900	S.CER ECJ0EB0J474K	T	7.9/129.6
C441	4030017440	S.CER ECJ0EC1H221J	T	12/126.2
C442	4510008780	S.ELE EEE1EA471P	B	9.6/119.8
C443	4030017460	S.CER ECJ0EB1E102K	T	111.9/88.2
C444	4030011070	S.CER GRM31M2C2H5R0CY21L (GRM42-6 CH) [USA-01]	B	147/148.9
	4030011070	S.CER GRM31M2C2H5R0CY21L (GRM42-6 CH) [EXP-01]		
	4030011070	S.CER GRM31M2C2H5R0CY21L (GRM42-6 CH) [USA-02]		
	4030011070	S.CER GRM31M2C2H5R0CY21L (GRM42-6 CH) [EXP-02]		
	4030011060	S.CER GRM31M2C2H4R0CY21L (GRM42-6 CH) [EUR-01]		
C446	4030017460	S.CER ECJ0EB1E102K	T	6.6/130.1
C448	4030017460	S.CER ECJ0EB1E102K	T	128.8/102.4
C449	4510008870	S.ELE EEE1AA471UP	B	8.9/139.2
C450	4030016930	S.CER ECJ0EB1A104K	T	7/125.3
C451	4030018860	S.CER ECJ0EB0J105K	T	8.6/125.3
C452	4030018860	S.CER ECJ0EB0J105K	T	72/98.2
C453	4030017460	S.CER ECJ0EB1E102K	T	130.8/103.6
C454	4030017430	S.CER ECJ0EC1H101J	B	46.3/56.9
C458	4030017460	S.CER ECJ0EB1E102K	T	114.8/95.7
C459	4030017460	S.CER ECJ0EB1E102K	T	116.3/119.1
C460	4030017460	S.CER ECJ0EB1E102K	B	9.6/147.3
C461	4030017420	S.CER ECJ0EC1H470J	T	114.8/94.8
C462	4030017420	S.CER ECJ0EC1H470J	T	115.3/119.1
C463	4030017420	S.CER ECJ0EC1H470J	B	9.6/146.4
C464	4510009680	S.ELE EEEFK1E471P	B	144.4/121.1
C465	4550006250	S.TAN TEESVA 1A 106M8R	T	102.7/92
C466	4030017420	S.CER ECJ0EC1H470J	T	99.9/88
C467	4030016930	S.CER ECJ0EB1A104K	T	62.3/58.5
C468	4030016930	S.CER ECJ0EB1A104K	T	61.7/56.9
C470	4030018860	S.CER ECJ0EB0J105K	T	7.4/122.3
C471	4030016790	S.CER ECJ0EB1C103K	T	7/124.4
C472	4030018860	S.CER ECJ0EB0J105K	T	10.9/117.7
C473	4030018860	S.CER ECJ0EB0J105K	T	5/118.9
C474	4030017780	S.CER ECJ0EB1E472K	T	115.3/17.6
C475	4510008120	S.ELE 16 CE 100 BS	T	125.1/12.1
C476	4510008120	S.ELE 16 CE 100 BS	T	125.1/19.3
C477	4030017780	S.CER ECJ0EB1E472K	T	119/12.3
C478	4030017780	S.CER ECJ0EB1E472K	T	115.3/12.2
C479	4510008120	S.ELE 16 CE 100 BS	T	104.8/14.3
C481	4030017460	S.CER ECJ0EB1E102K	B	63.2/122.2
C491	4030016930	S.CER ECJ0EB1A104K	T	60.4/60.1
C492	4030016930	S.CER ECJ0EB1A104K	B	13.5/32.6
C493	4510008870	S.ELE EEE1AA471UP	B	66.3/45.3
C494	4030016930	S.CER ECJ0EB1A104K	T	117.2/92.6
C495	4030016930	S.CER ECJ0EB1A104K	T	117.2/90.7
C496	4030016930	S.CER ECJ0EB1A104K	T	122.4/92.2
C497	4030016930	S.CER ECJ0EB1A104K	T	109.7/82
C498	4030016930	S.CER ECJ0EB1A104K	T	11.4/43.2
C501	4030017420	S.CER ECJ0EC1H470J	T	12.2/31.2
C502	4030017420	S.CER ECJ0EC1H470J	T	29.5/2.8
C503	4030017420	S.CER ECJ0EC1H470J	T	48/99.4
C506	4030016930	S.CER ECJ0EB1A104K	B	26.3/43.3
C507	4030016930	S.CER ECJ0EB1A104K	B	32.9/31
C508	4030016930	S.CER ECJ0EB1A104K	B	40.1/42.7
C509	4030016930	S.CER ECJ0EB1A104K	B	26.2/39
C510	4030016930	S.CER ECJ0EB1A104K	B	26.6/33
C511	4030016930	S.CER ECJ0EB1A104K	B	40.1/34.2
C512	4030017420	S.CER ECJ0EC1H470J	T	92/14.7
C513	4550006250	S.TAN TEESVA 1A 106M8R	B	8.4/59.8
C514	4030016930	S.CER ECJ0EB1A104K	B	11.7/53.5
C515	4030016930	S.CER ECJ0EB1A104K	B	15.5/54.4
C516	4030016930	S.CER ECJ0EB1A104K	T	65.1/69.6
C517	4030016930	S.CER ECJ0EB1A104K	B	15.6/63.1

[MAIN UNIT]

REF NO.	ORDER NO.	DESCRIPTION	M.	H/V LOCATION
C518	4030016930	S.CER ECJ0EB1A104K	B	12.4/62.4
C519	4030017460	S.CER ECJ0EB1E102K	B	15.6/59.9
C521	4030016930	S.CER ECJ0EB1A104K	B	18.1/53.6
C522	4030016930	S.CER ECJ0EB1A104K	T	51.2/31.8
C523	4030016930	S.CER ECJ0EB1A104K	T	51.2/33
C524	4030018910	S.CER C1608 JB 0J 475K-T	T	9.5/56
C525	4030018910	S.CER C1608 JB 0J 475K-T	B	25.8/58.3
C526	4030017730	S.CER ECJ0EB1E471K	B	29.8/57.9
C527	4030016790	S.CER ECJ0EB1C103K	B	26.1/50.3
C528	4030017670	S.CER ECJ0EC1H390J	B	37.4/120.7
C529	4030017630	S.CER ECJ0EC1H120J	B	38.3/112.2
C530	4030017420	S.CER ECJ0EC1H470J	T	60.4/62.3
C531	4030017670	S.CER ECJ0EC1H390J	B	93.3/62
C532	4030017670	S.CER ECJ0EC1H390J	B	93.6/52.9
C533	4510008120	S.ELE 16 CE 100 BS	T	125.1/26.4
C534	4030016790	S.CER ECJ0EB1C103K	T	118.5/26.7
C535	4030016790	S.CER ECJ0EB1C103K	B	67.4/101.6
C536	4030016790	S.CER ECJ0EB1C103K	B	65.7/98.3
C538	4030006860	S.CER C1608 JB 1H 102K-T	T	36.2/145.1
C539	4030017790	S.CER ECJ0EB1E682K	T	22.8/57
C540	4030017730	S.CER ECJ0EB1E471K	T	21.2/56.6
C541	4030016930	S.CER ECJ0EB1A104K	T	22.8/55.4
C542	4030017440	S.CER ECJ0EC1H221J	T	27.1/55
C543	4030016930	S.CER ECJ0EB1A104K	T	56.5/68.9
C544	4030017460	S.CER ECJ0EB1E102K	T	62.4/72.9
C545	4030011060	S.CER GRM31M2C2H4R0CY21L (GRM42-6 CH) [USA-01]	T	97.6/106.8
	4030011060	S.CER GRM31M2C2H4R0CY21L (GRM42-6 CH) [EXP-01]		
	4030011050	S.CER GRM31M3C2H3R0CY21L (GRM42-6 CJ) [USA-02]		
	4030011050	S.CER GRM31M3C2H3R0CY21L (GRM42-6 CJ) [EXP-02]		
	4030011060	S.CER GRM31M2C2H4R0CY21L (GRM42-6 CH) [EUR-01]		
C546	4030018910	S.CER C1608 JB 0J 475K-T	B	40.4/56.7
C547	4030017760	S.CER ECJ0EB1H222K	T	53.7/72.1
C548	4030016930	S.CER ECJ0EB1A104K	T	14.1/120.6
C549	4030017420	S.CER ECJ0EC1H470J	T	23.1/86.8
C550	4030017420	S.CER ECJ0EC1H470J	T	70.1/82.6
C551	4030017330	S.CER ECJ0EF1C104Z	T	114.2/28.9
C552	4030016790	S.CER ECJ0EB1C103K	B	121.9/48.8
C553	4030016930	S.CER ECJ0EB1A104K	B	30.8/19.4
C555	4030016930	S.CER ECJ0EB1A104K	B	69.8/75.5
C556	4030016930	S.CER ECJ0EB1A104K	T	105.2/28.6
C557	4030016930	S.CER ECJ0EB1A104K	T	97/28.6
C558	4550006250	S.TAN TEESVA 1A 106M8R	T	95.1/27.9
C559	4550007080	S.TAN TEESVA 1C 106M8R	T	45.9/75.5
C562	4030017420	S.CER ECJ0EC1H470J	T	38.5/76.1
C563	4030016930	S.CER ECJ0EB1A104K	B	26.5/122.3
C564	4030017570	S.CER ECJ0EC1H040B	B	68.3/131.3
C565	4030017340	S.CER ECJ0EC1H010B	B	47.9/113.5
C566	4030018860	S.CER ECJ0EB0J105K	B	39/72.7
C571	4030017580	S.CER ECJ0EC1H060C	T	64.6/99.1
C572	4030017580	S.CER ECJ0EC1H060C	T	65.6/99.1
C573	4030017580	S.CER ECJ0EC1H060C	T	65.3/97.4
C574	4030017580	S.CER ECJ0EC1H060C	B	64/134.7
C575	4030017420	S.CER ECJ0EC1H470J	B	62.9/132.4
C576	4030017460	S.CER ECJ0EB1E102K	T	67.1/106.5
C577	4030017460	S.CER ECJ0EB1E102K	T	67.1/104.9
C578	4030017200	S.CER GRM31BR32J102KY01L (GHM1030 R)	T	92/126
C579	4550006250	S.TAN TEESVA 1A 106M8R	B	94.7/50.6
C580	4030017420	S.CER ECJ0EC1H470J	T	100.7/73.5
C581	4030018910	S.CER C1608 JB 0J 475K-T	B	46.3/60.9
C582	4030018910	S.CER C1608 JB 0J 475K-T	B	69.7/98.2
C583	4030016930	S.CER ECJ0EB1A104K	B	46.3/58.6
C584	4030016790	S.CER ECJ0EB1C103K	B	54.9/55.3
C585	4030016930	S.CER ECJ0EB1A104K	B	54.9/58.6
C586	4030017730	S.CER ECJ0EB1E471K	B	54.9/57.9
C587	4030016790	S.CER ECJ0EB1C103K	B	52.3/59.8
C588	4030018910	S.CER C1608 JB 0J 475K-T	T	70.9/98.2
C601	4030011060	S.CER GRM31M2C2H4R0CY21L (GRM42-6 CH) [USA-01]	T	97.6/111.3
	4030011060	S.CER GRM31M2C2H4R0CY21L (GRM42-6 CH) [EXP-01]		
	4030011060	S.CER GRM31M2C2H4R0CY21L (GRM42-6 CH) [USA-02]		
	4030011060	S.CER GRM31M2C2H4R0CY21L (GRM42-6 CH) [EXP-02]		
	4030011070	S.CER GRM31M2C2H5R0CY21L (GRM42-6 CH) [EUR-01]		
C610	4030018080	S.CER ECJ0EB1H182K	T	63.3/69.6
C612	4030017460	S.CER ECJ0EB1E102K	B	55.7/29.9
C614	4030017730	S.CER ECJ0EB1E471K	B	29/13.2
C615	4030017650	S.CER ECJ0EC1H270J	B	63.2/117.5
C616	4030017460	S.CER ECJ0EB1E102K	T	93.8/64.6
C617	4030017420	S.CER ECJ0EC1H470J	T	60/64.8
C618	4030017420	S.CER ECJ		

[MAIN UNIT]

REF NO.	ORDER NO.	DESCRIPTION	M.	H/V LOCATION
J4	6510023511	S.CON 28FLT-SM2-TB(LF)(SN)	T	70.8/102
J5	6510023110	CON 3008L-8P8C <KIN>		
J6	6450000140	CON HSJ0807-01-010		
J8	6510023092	S.CON 20FLT-SM2-TB(LF)(SN)(M)	T	59.1/15.6
J9	6510019371	S.CON B3B-ZR-SM4-TF(LF)(SN)	T	94.6/14.3
J10	6510004910	CON NR-DS-E 01		
J11	6510004910	CON NR-DS-E 01		
DS1	5040002961	S.LED SML-A12MT T86J	B	96/1.1
DS2	5040002961	S.LED SML-A12MT T86J	B	126/1.1
DS3	5040003000	S.LED SML-A12UT-T86	B	111/1.1
MF1	2710000870	FAN AFB0512HB-7X22 <USE>HK		
W1	7120000470	JUM ERDS2T0		
W2	7120000470	JUM ERDS2T0		
W4	8900017520	CAB OPC-1783		
EP1	6910015370	S.BEA ACZ1005Y-102-T	B	129.1/48.4
EP2	6910015370	S.BEA ACZ1005Y-102-T	B	117.2/48.4
EP3	6910015370	S.BEA ACZ1005Y-102-T	B	32.4/81.6
EP4	6910016330	S.BEA MMZ1005S 601CT-S	B	30.4/60.5
EP5	6910015370	S.BEA ACZ1005Y-102-T	B	39/74.5
EP6	6910015370	S.BEA ACZ1005Y-102-T	B	37.8/109
EP7	6910016330	S.BEA MMZ1005S 601CT-S	B	40.7/36.7
EP8	6910015370	S.BEA ACZ1005Y-102-T	B	94.5/48.8
EP9	6910016330	S.BEA MMZ1005S 601CT-S	T	48.8/39.3
EP10	6910011560	BEA HF70BB4.5X5X1.6		
EP13	6910011330	TER OT-009 M3		
EP14	6910011330	TER OT-009 M3		

[CONNECT UNIT]

REF NO.	ORDER NO.	DESCRIPTION	M.	H/V LOCATION
C601	4030017420	S.CER ECJ0EC1H470J	T	13.8/12.4
C602	4030017400	S.CER ECJ0EC1H220J	T	12.2/12.4
C603	4030017420	S.CER ECJ0EC1H470J	T	16.5/12.4
C604	4030017400	S.CER ECJ0EC1H220J	T	15/14.2
C605	4030017420	S.CER ECJ0EC1H470J	T	17.8/13.9
C606	4030017420	S.CER ECJ0EC1H470J	T	19.4/12.4
C607	4030017420	S.CER ECJ0EC1H470J	T	20.5/13.9
C608	4030017420	S.CER ECJ0EC1H470J	T	22.6/12.4
C609	4030017420	S.CER ECJ0EC1H470J	T	25.5/12.4
C610	4030017420	S.CER ECJ0EC1H470J	T	29.7/12.8
C611	4030017420	S.CER ECJ0EC1H470J	T	31/14.1
C612	4030017420	S.CER ECJ0EC1H470J	T	32.4/12.8
C613	4030017420	S.CER ECJ0EC1H470J	T	33.5/14.1
C614	4030017420	S.CER ECJ0EC1H470J	T	35.2/14.1
C615	4030017420	S.CER ECJ0EC1H470J	T	35.7/12.8
C616	4030017420	S.CER ECJ0EC1H470J	B	35.2/15.6
C617	4030017420	S.CER ECJ0EC1H470J	T	37.5/13.5
C618	4030017420	S.CER ECJ0EC1H470J	T	39.3/12.2
C619	4030017420	S.CER ECJ0EC1H470J	T	39.9/13.4
C620	4030017420	S.CER ECJ0EC1H470J	T	41.3/12.6
C621	4030017420	S.CER ECJ0EC1H470J	T	27.4/13.9
J601	6510026290	S.CON IMSA-9631S-28Y921	B	22.8/16.2
J602	6510023210	CON CD6125SA1J0 <CVI>		
S1	2260003070	S.SWI MINISMDC150F/24-2	B	38.9/18
W601	8900017500	CAB OPC-1852 (P0.5,N28,L90) <TJM>		

M.=Mounted side (T: Mounted on the Top side, B: Mounted on the Bottom side)  
S.=Surface mount

# VOLTAGE DIAGRAM

## MAIN UNIT (1/3)

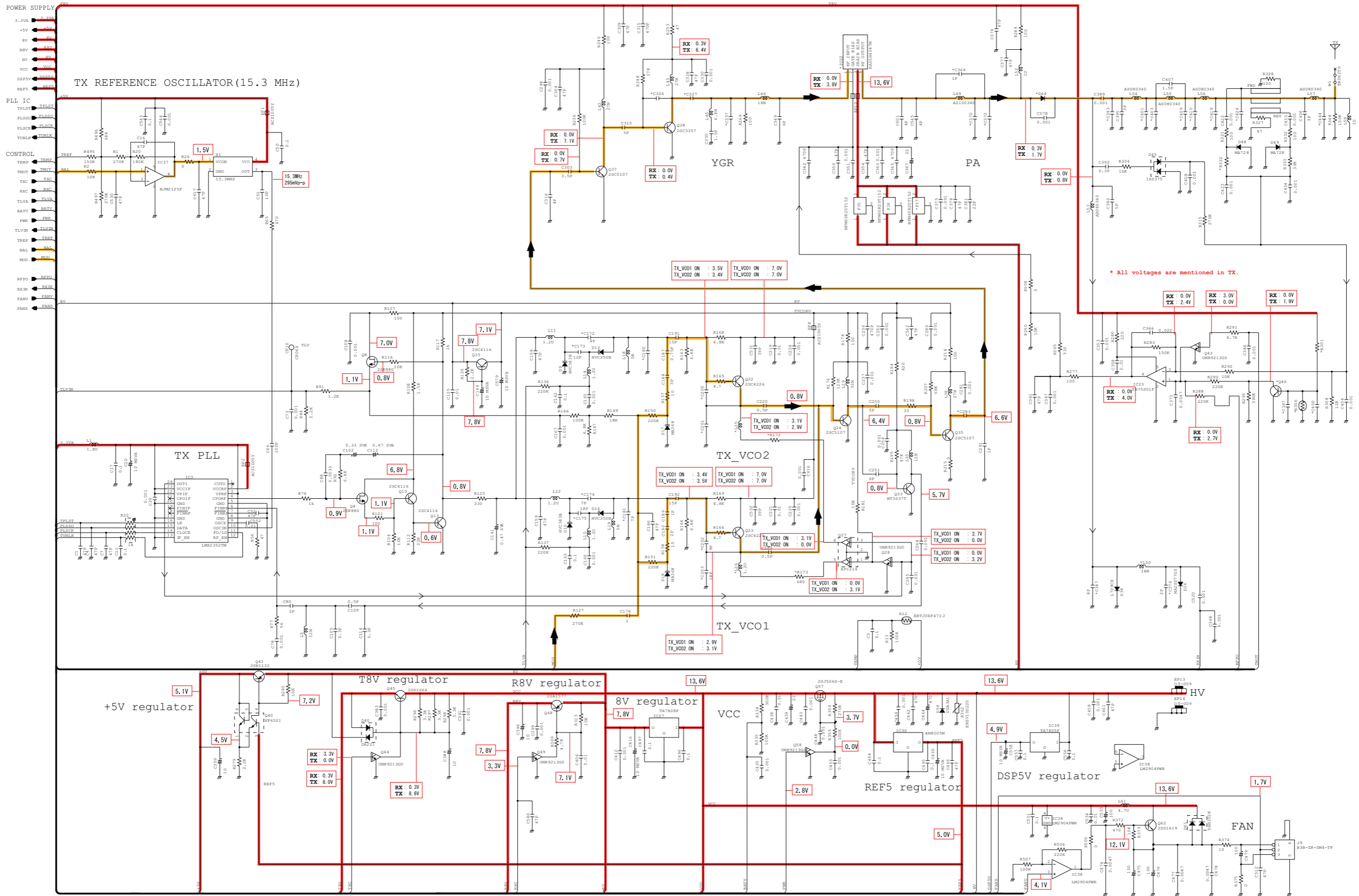

\*; Refer to "PARTS LIST."



# MAIN UNIT (2/3)

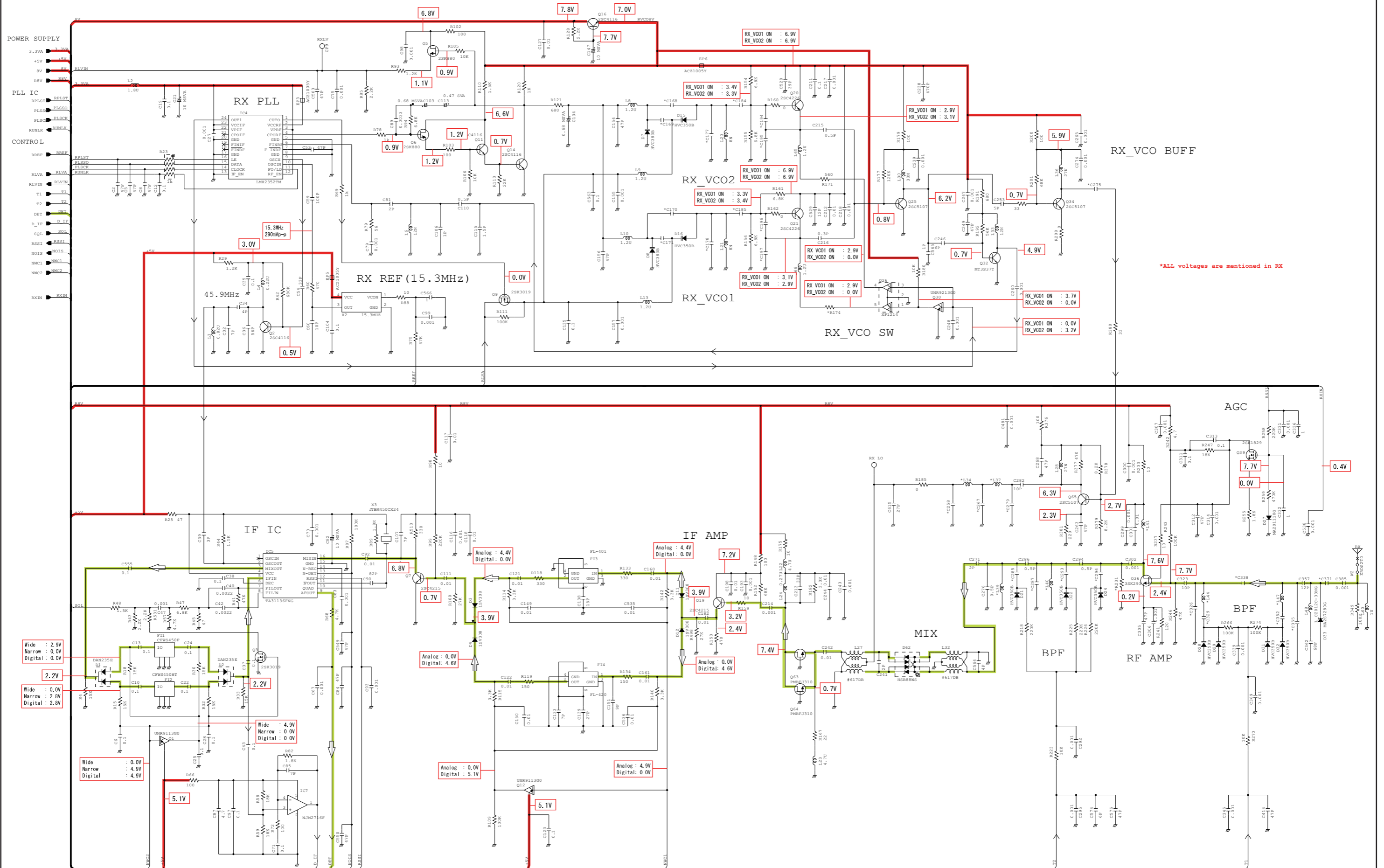

\*ALL voltages are mentioned in RX

\*; Refer to "PARTS LIST."

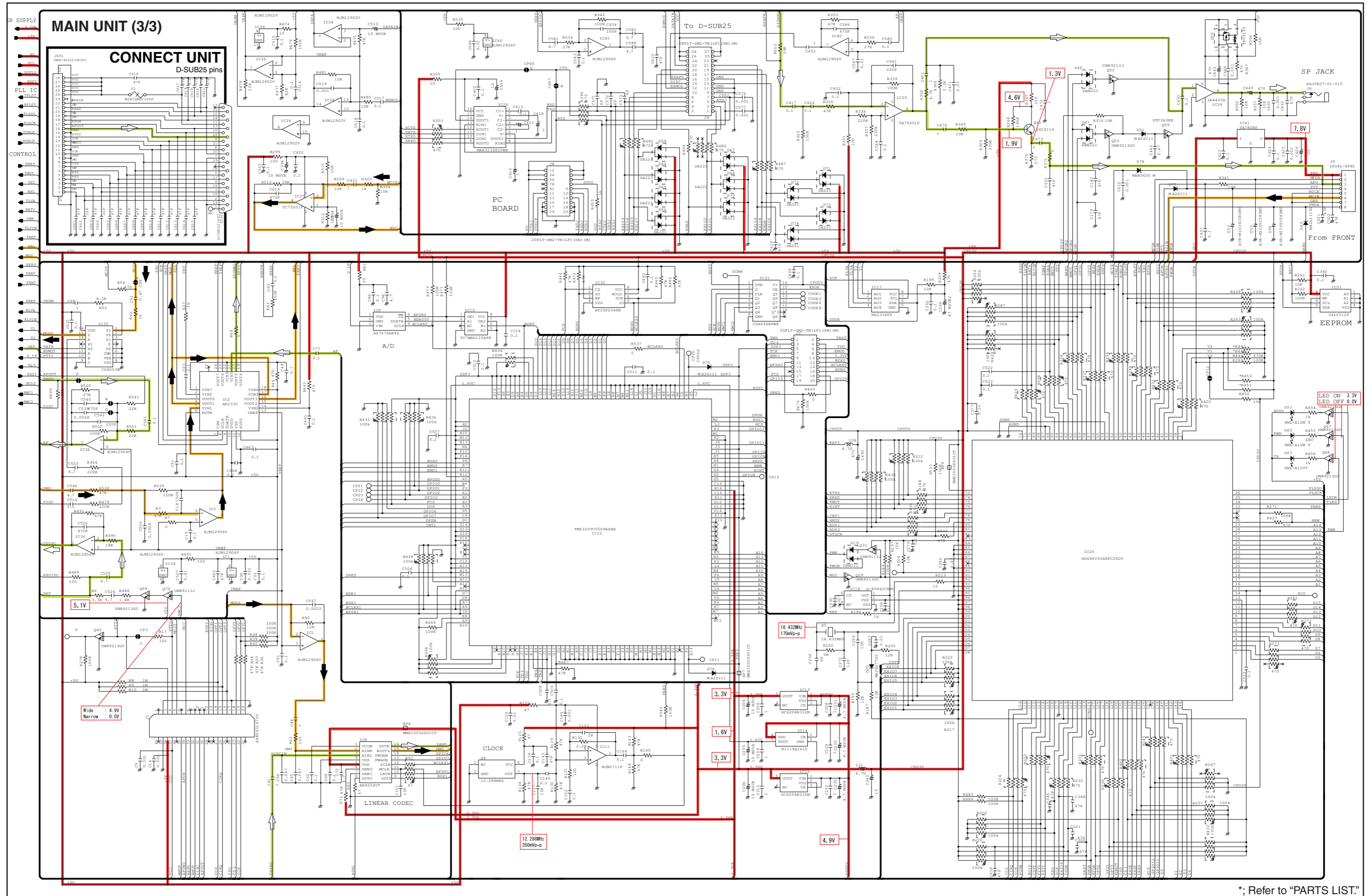

\*; Refer to "PARTS LIST."

Dec. 2008



# SERVICE MANUAL ADDENDUM

---

## UR-FR6000 UR-FR6100

---

### CONTENTS

REPLACEMENT PAGES .....	6-3, 5, 8, 9
PARTS LIST .....	1
VOLTAGE DIAGRAM .....	9



**ADJUSTMENT CHANNEL LISTS**

Clone the adjust channels into the repeater before starting adjustment. Each channel must be assigned [Frequency], [RF PWR], [CH Type], [TX C. Tone] and [W/N] as below.

**• Channel list for [Low band] version**

CH	Atr	Inh	Operation Mode	Frequency (MHz)			Text	TOT				Loc	on	CH Type	Au Res	FM		
				RX	TX	Tx Inh		Local Mic	Repeat/EPTT	RF PWR	Lock out					TX C. Tone	W/N	Com
1-1	AB		Simplex	400.100000	<-		LV L ADJ					L1	Analog	Tim			W	
1-2			Simplex	435.100000	<-		LV H ADJ					L1	Analog	Tim			W	
1-3			Simplex	434.950000	<-		LV L URFY					L1	Analog	Tim			W	
1-4			Simplex	469.900000	<-		LV H URFY					L1	Analog	Tim			W	
1-5			Simplex	469.900000	<-		TX Freq					L1	Analog	Tim			W	
1-6			Simplex	400.100000	<-		TX PWR H1					H	Analog	Tim			W	
1-7			Simplex	400.100000	<-		TX PWR L2					L2	Analog	Tim			W	
1-8			Simplex	400.100000	<-		TX PWR L1					L1	Analog	Tim			W	
1-9			Simplex	400.100000	<-		BAL					L1	Analog	Tim			W	
1-10			Simplex	435.100000	<-		BAL Offset					L1	Analog	Tim			W	
1-11			Simplex	400.100000	<-		DG Dev.					L1	Digital	Tim	----	-	-	
1-12			Simplex	411.500000	<-		DG Dev. 0					L1	Digital	Tim	----	-	-	
1-13			Simplex	423.200000	<-		DG Dev. 1					L1	Digital	Tim	----	-	-	
1-14			Simplex	434.900000	<-		DG Dev. 2					L1	Digital	Tim	----	-	-	
1-15			Simplex	435.100000	<-		DG Dev. Offs					L1	Digital	Tim	----	-	-	
1-16			Simplex	446.600000	<-		DG Dev. 3					L1	Digital	Tim	----	-	-	
1-17			Simplex	458.300000	<-		DG Dev. 4					L1	Digital	Tim	----	-	-	
1-18			Simplex	469.900000	<-		DG Dev. 5					L1	Digital	Tim	----	-	-	
1-19			Simplex	400.100000	<-		AN Dev. W					L1	Analog	Tim			W	
1-20			Simplex	400.100000	<-		AN Dev. M					L1	Analog	Tim			W	
1-21			Simplex	400.100000	<-		AN Dev. N					L1	Analog	Tim			N	
1-22			Simplex	400.100000	<-		CT/DT Dev.					L1	Analog	Tim		151.4	W	
1-23			Simplex	435.000000	<-	i	BPF C ALL					L1	Analog	Tim			W	
1-24			Simplex	400.100000	<-	i	BPF L ALL					L1	Analog	Tim			W	
1-25			Simplex	469.900000	<-	i	BPF H ALL					L1	Analog	Tim			W	
1-26			Simplex	400.100000	<-	i	RSSI					L1	Analog	Tim			W	
1-27			Simplex	400.100000	<-	i	SQL					L1	Analog	Tim			W	

**• Channel list for [High band] version**

CH	Atr	Inh	Operation Mode	Frequency (MHz)			Text	TOT				Loc	on	CH Type	Au Res	FM		
				RX	TX	Tx Inh		Local Mic	Repeat/EPTT	RF PWR	Lock out					TX C. Tone	W/N	Com
1-1	AB		Simplex	450.100000	<-		LV L ADJ					L1	Analog	Tim			W	
1-2			Simplex	485.100000	<-		LV H ADJ					L1	Analog	Tim			W	
1-3			Simplex	484.950000	<-		LV L URFY					L1	Analog	Tim			W	
1-4			Simplex	519.900000	<-		LV H URFY					L1	Analog	Tim			W	
1-5			Simplex	519.900000	<-		TX Freq					L1	Analog	Tim			W	
1-6			Simplex	450.100000	<-		TX PWR H1					H	Analog	Tim			W	
1-7			Simplex	450.100000	<-		TX PWR L2					L2	Analog	Tim			W	
1-8			Simplex	450.100000	<-		TX PWR L1					L1	Analog	Tim			W	
1-9			Simplex	450.100000	<-		BAL					L1	Analog	Tim			W	
1-10			Simplex	485.100000	<-		BAL Offset					L1	Analog	Tim			W	
1-11			Simplex	450.100000	<-		DG Dev.					L1	Digital	Tim	----	-	-	
1-12			Simplex	461.500000	<-		DG Dev. 0					L1	Digital	Tim	----	-	-	
1-13			Simplex	473.200000	<-		DG Dev. 1					L1	Digital	Tim	----	-	-	
1-14			Simplex	484.900000	<-		DG Dev. 2					L1	Digital	Tim	----	-	-	
1-15			Simplex	485.100000	<-		DG Dev. Offs					L1	Digital	Tim	----	-	-	
1-16			Simplex	496.600000	<-		DG Dev. 3					L1	Digital	Tim	----	-	-	
1-17			Simplex	508.300000	<-		DG Dev. 4					L1	Digital	Tim	----	-	-	
1-18			Simplex	519.900000	<-		DG Dev. 5					L1	Digital	Tim	----	-	-	
1-19			Simplex	450.100000	<-		AN Dev. W					L1	Analog	Tim			W	
1-20			Simplex	450.100000	<-		AN Dev. M					L1	Analog	Tim			W	
1-21			Simplex	450.100000	<-		AN Dev. N					L1	Analog	Tim			N	
1-22			Simplex	450.100000	<-		CT/DT Dev.					L1	Analog	Tim		151.4	W	
1-23			Simplex	450.100000	<-	i	BPF C ALL					L1	Analog	Tim			W	
1-24			Simplex	519.900000	<-	i	BPF H ALL					L1	Analog	Tim			W	
1-25			Simplex	450.100000	<-	i	RSSI					L1	Analog	Tim			W	
1-26			Simplex	450.100000	<-	i	SQL					L1	Analog	Tim			W	

**ADJUST UTILITY WINDOW**

Adjust Utility			
Setting			
	CH No.	1	Receive Sim
	RX Freq.		451.10000MHz
	TX Freq.		452.10000MHz
	RF Power.		Low
	W/N		Wide
	CH Type		FX=Digital TX=Digital
Mode setting	TX Mode	17	Digital PNB
	RX Mode	2	Digital
	AF Volume	0	[-----]
Adjust			
TX output power	Power (H)	208	[-----]
	Power (L2)	150	[-----]
	Power (L1)	76	[-----]
Analog deviation	MOD (Wide)	139	[-----]
	MOD (Mid)	144	[-----]
	MOD (Narrow)	65	[-----]
	MOD (Digital)	105	[-----]
CTCSS/DTCS deviation	CTCSS/DTCS	137	[-----]
	S.Tone	75	[-----]
Squelch	SQL	50	[---]
Expert			
TX frequency	RX REF	178	[-----]
	TX REF	126	[-----]
Lock volatge (Preset)	RX LVA L	80	[-----] [Enter] to Sweep
	RX LVA H	62	[-----] [Enter] to Sweep
	TX LVA L	166	[-----] [Enter] to Sweep
	TX LVA H	105	[-----] [Enter] to Sweep
Lock volatge (Adjustment)	LV (RX L)	36	0.70V
	LV (RX H)	36	0.70V
	LV (TX L)	36	0.70V
	LV (TX H)	36	0.70V
S-meter	RSSI	74	[Enter] to Capture
Modulation balance	BAL	174	[-----]
	BAL Offset (High)	0	[-----]
Modulation balance (High)	PWR Hi Slant Band 0	0	[-----] 399.900000 - 411.599999 MHz
	PWR Hi Slant Band 1	3	[-----] 411.600000 - 423.299999 MHz
	PWR Hi Slant Band 2	4	[-----] 423.300000 - 434.999999 MHz
	PWR Hi Slant Band 3	25	[-----] 435.000000 - 446.699999 MHz
	PWR Hi Slant Band 4	8	[-----] 446.700000 - 458.399999 MHz
	PWR Hi Slant Band 5	6	[-----] 458.400000 - 470.099999 MHz
	PWR Hi Slant Band 6	0	[-----] 470.100000 - 481.799999 MHz
	PWR L2 Slant Band 0	0	[-----] 399.900000 - 411.599999 MHz
	PWR L2 Slant Band 1	4	[-----] 411.600000 - 423.299999 MHz
	PWR L2 Slant Band 2	4	[-----] 423.300000 - 434.999999 MHz
	PWR L2 Slant Band 3	17	[-----] 435.000000 - 446.699999 MHz
	PWR L2 Slant Band 4	8	[-----] 446.700000 - 458.399999 MHz
	PWR L2 Slant Band 5	6	[-----] 458.400000 - 470.099999 MHz
	PWR L2 Slant Band 6	0	[-----] 470.100000 - 481.799999 MHz
	PWR L1 Slant Band 0	0	[-----] 399.900000 - 411.599999 MHz
	PWR L1 Slant Band 1	0	[-----] 411.600000 - 423.299999 MHz
	PWR L1 Slant Band 2	2	[-----] 423.300000 - 434.999999 MHz
	PWR L1 Slant Band 3	14	[-----] 435.000000 - 446.699999 MHz
PWR L1 Slant Band 4	6	[-----] 446.700000 - 458.399999 MHz	
PWR L1 Slant Band 5	4	[-----] 458.400000 - 470.099999 MHz	
PWR L1 Slant Band 6	0	[-----] 470.100000 - 481.799999 MHz	
Digital deviation	MOD Slant Band 0	0	[-----] 399.900000 - 411.599999 MHz
	MOD Slant Band 1	-9	[-----] 411.600000 - 423.299999 MHz
	MOD Slant Band 2	-13	[-----] 423.300000 - 434.999999 MHz
	MOD Slant Band 3	-2	[-----] 435.000000 - 446.699999 MHz
	MOD Slant Band 4	-5	[-----] 446.700000 - 458.399999 MHz
	MOD Slant Band 5	2	[-----] 458.400000 - 470.099999 MHz
	MOD Slant Band 6	0	[-----] 470.100000 - 481.799999 MHz
	MOD Offset (High)	0	[-----]
Receive sensitivity (Band center)	BPF C ALL		[Enter] to Sweep
	BPF T1 C	4	[-----] [Enter] to Sweep
	BPF T2 C	25	[-----] [Enter] to Sweep
*Receive sensitivity (Band low)	BPF L ALL		[Enter] to Sweep
	BPF T1 L	80	[-----] [Enter] to Sweep
Receive sensitivity (Band high)	BPF T2 L	45	[-----] [Enter] to Sweep
	BPF H ALL		[Enter] to Sweep
	BPF T1 H	69	[-----] [Enter] to Sweep
	BPF T2 H	53	[-----] [Enter] to Sweep

\*[Low band] only

### 6-3 TRANSMIT ADJUSTMENT (continued)

- 1) Select an adjustment item using cursor or [↑] / [↓] keys of the PC's keyboard.  
 2) Set or modify the adjustment value as specified using [←] / [→] keys of the PC's keyboard, then push the [ENTER] key.

ADJUSTMENT	ADJUSTMENT CONDITION	OPERATION	ADJUSTMENT ITEM	VALUE
<b>ANALOG DEVIATION -Preparation-</b>	1	–	• Set the item [TX Mode] to "1."	[TX Mode] "1"
	2	• Connect a Modulation Analyzer to the TX antenna connector through an attenuator.	• Set the Modulation Analyzer as; HPF : OFF LPF : 20 kHz De-emphasis : OFF Detector : (P-P)/2	– –
	3	• Connect an Audio Generator to the MIC line through the JIG cable.	• Set the Audio Generator as; Modulation : 1 kHz Level : 40 mV rms Wave form : Sine wave	– –
<b>-Adjust- (Wide)</b>	4	• CH. : 1-10 • Transmitting	1) Adjust the deviation using [←] / [→] keys of the PC's keyboard. 2) Push the [ENTER] key to store the adjust value.	[MOD (Wide)] ±4.05–4.15 kHz
<b>(Middle) &lt;[FR6100] only&gt;</b>	5	• CH. : 1-11 • [Wide Band Width] : "Middle" (see the page 6-4) • Transmitting		[MOD (Middle)] ±3.15–3.25 kHz
<b>(Narrow)</b>	6	• CH. : 1-12 • Transmitting		[MOD (Narrow)] ±2.05–2.15 kHz
<b>CTCSS/DTCSS DEVIATION -Preparation-</b>	1	–	• Set the item [TX Mode] to "3."	[TX Mode] "3"
<b>-Adjust-</b>	2	• CH. : 1-19 • Transmitting	1) Adjust the deviation using [←] / [→] keys of the PC's keyboard. 2) Push the [ENTER] key to store the adjust value.	[CTCSS] ±0.68–0.72 kHz

### 6-4 RECEIVE ADJUSTMENT

- 1) Select an adjustment item using cursor or [↑] / [↓] keys of the PC's keyboard.  
 2) Set or modify the adjustment value as specified using [←] / [→] keys of the PC's keyboard, then push the [ENTER] key.

ADJUSTMENT	ADJUSTMENT CONDITION	OPERATION	ADJUSTMENT ITEM/POINT	VALUE
<b>RECEIVE SENSITIVITY -Preparation-</b>	1	–	• Set the item [RX Mode] to "1."	[RX Mode] "1"
	2	• Connect an SSG to the RX antenna connector.	• SSG common setting; Level : +20 dB <sub>μ</sub> Modulation : 1 kHz Deviation : 3.5 kHz	– –
<b>-Adjustment- (Band center)</b>	3	• CH. : 1-23 [Low] : 1-23 [High] • Receiving	1) Set the SSG as; Frequency : 435.000 MHz [Low] 450.100 MHz [High] 2) Select the item [BPF C ALL], then push the [ENTER] key.	[BPF C ALL]
<b>-Adjustment- (Band center) For [Low band] version only</b>	4	• CH. : 1-24 [Low] only • Receiving	1) Set the SSG as; Frequency : 400.100 MHz [Low] 2) Select the item [BPF L ALL], then push the [ENTER] key.	[BPF L ALL]
<b>-Adjustment- (Band high)</b>	5	• CH. : 1-22 [Low] : 1-24 [High] • Receiving	1) Set the SSG as; Frequency : 469.900 MHz [Low] 519.900 MHz [High] 2) Select the item [BPF H ALL], then push the [ENTER] key.	[BPF H ALL]



**6-4 RECEIVE ADJUSTMENT (continued)**

1) Select an adjustment item using cursor or [↑] / [↓] keys of the PC's keyboard.

2) Set or modify the adjustment value as specified using [←] / [→] keys of the PC's keyboard, then push the [ENTER] key.

ADJUSTMENT	ADJUSTMENT CONDITION	OPERATION	ADJUSTMENT ITEM/POINT	VALUE	
<b>S-METER</b> <b>-Preparation-</b>	<b>NOTE:</b> "RECEIVE SENSITIVITY" MUST be adjusted before "S-METER." When "RECEIVE SENSITIVITY" is re-adjusted, "S-METER" MUST be re-adjusted too.				
	1	<ul style="list-style-type: none"> <li>• Connect an SSG to the RX antenna connector.</li> </ul>	<ul style="list-style-type: none"> <li>• Set the SSG as;                      Frequency : 400.100 MHz [Low band]                      450.100 MHz [High band]                      Modulation : 1 kHz                      Deviation : 3.5 kHz</li> </ul>	-	-
<b>-Adjust-</b> <b>(S3 level)</b>	2	<ul style="list-style-type: none"> <li>• CH. : 1-26 [Low] : 1-25 [High]</li> <li>• Receiving</li> </ul>	1) Set the SSG as; Level : +23 dB <sub>μ</sub> 2) Select the item <b>[RSSI S3 Level]</b> , then push the [ENTER] key to store the adjust value.	<b>[RSSI S3 Level]</b>	(Automatic adjustment)
<b>(S1 level)</b>	3	<ul style="list-style-type: none"> <li>• CH. : 1-26 [Low] : 1-25 [High]</li> <li>• Receiving</li> </ul>	1) Set the SSG as; Level : -7 dB <sub>μ</sub> 2) Select the item <b>[RSSI S1 Level]</b> , then push the [ENTER] key, to store the adjust value.	<b>[RSSI S1 Level]</b>	(Automatic adjustment)
<b>SQUELCH</b> <b>-Preparation-</b>	1	-	• Set the item <b>[SQL Level]</b> to "2."	<b>[SQL Level]</b>	"2"
	2	<ul style="list-style-type: none"> <li>• Connect an SSG to the RX antenna connector.</li> </ul>	<ul style="list-style-type: none"> <li>• Set the SSG as;                      Frequency : 400.100 MHz [Low band]                      450.100 MHz [High band]                      Modulation : 1 kHz                      Deviation : 3.5 kHz                      Level : -14 dB<sub>μ</sub></li> </ul>	-	-
<b>-Adjust-</b>	2	<ul style="list-style-type: none"> <li>• CH. : 1-27 [Low] : 1-26 [High]</li> <li>• Receiving</li> </ul>	1) Decrease the adjustment value <b>[SQL]</b> to close the squelch once, then increase the value to open the squelch. 2) Select the item <b>[SQL]</b> , then push the [ENTER] key to store the adjust value.	<b>[SQL]</b>	(Automatic adjustment)

## PARTS LIST

## [MAIN UNIT]

REF NO.	ORDER NO.	DESCRIPTION	M.	H/V LOCATION
IC1	1110005330	S.IC NJM12904V-TE1-#ZZZB	T	58.1/71.4
IC2	1110007290	S.IC AK2330P-L	T	58.7/56.1
IC3	1130010100	S.IC LMX2352TMX/NOPB	B	120.2/43.9
IC4	1130010100	S.IC LMX2352TMX/NOPB	B	28/78.8
IC5	1110003491	S.IC TA31136FNG(D,EL)	B	70.4/82.5
IC7	1110007280	S.IC NJM2716F-TE1-#ZZZB	B	56.8/46.4
IC8	1130012910	S.IC AK4554VTP-E2/P	B	36.2/59.9
IC9	1190002080	S.IC AD7476ARTZ-500RL7	B	49.6/46.4
IC10	1130013040	S.IC TC7WBD125AFK(T5L,F)	B	46.6/49.2
IC11	1110006230	S.IC NJM2711F-TE1-#ZZZB	B	53.1/35
IC12	1140013290	S.IC TMS320VC5509AZHH	B	33.3/37.8
IC13	1180002590	S.REG XC6204B332MR	T	80.9/21.3
IC14	1180003270	S.REG R1114Q161D-TR-F	T	84.4/21.4
IC15	1180002590	S.REG XC6204B332MR	T	87.8/21.3
IC17	1190001340	S.IC M62334FP 600C	T	67.3/61.7
IC18	1110005771	S.IC S-80942CNMC-G9CT2G	T	41.2/52.8
IC20	1140014550	S.IC HD64F2506RFC26DV(EMPTY)	T	33.5/37.6
IC21	1140012950	S.IC 24LC512T-I/SM	T	59.1/21.8
IC22	1150002211	IC RA55H4047M-121 [USA-01]		
	1150002211	IC RA55H4047M-121 [EXP-01]		
	1150002221	IC RA55H4452M-121 [USA-02]		
	1150002221	IC RA55H4452M-121 [EXP-02]		
	1150002092	IC RA30H4047M-121 [EUR-01]		
IC23	1110002751	S.IC TA75S01F(TE85R,F)	T	139.3/125.6
IC25	1130008561	S.IC TC7S551F(TE85L,F)	B	29/16.3
IC26	1120003070	S.IC MAX3232EIPWR	T	42.7/70
IC27	1180001251	S.IC TA7808F(TE16L,Q)	T	116.6/84.1
IC28	1110003091	IC LA4425A-E		
IC29	1110002751	S.IC TA75S01F(TE85R,F)	T	12/123.1
IC30	1110003390	S.IC AN8005M-(E1)	T	114.1/91.8
IC31	1130011760	S.IC CD4094BPWR	T	8.1/45.2
IC32	1130013360	S.IC AT25F2048N-10SU-2.7SL383	B	8.9/36.1
IC34	1110005340	S.IC NJM12902V-TE1-#ZZZB	B	12.2/58.2
IC35	1140013200	S.IC CD4094BPWR	B	20.6/58.2
IC36	1110005330	S.IC NJM12904V-TE1-#ZZZB	B	27.8/55.4
IC37	1120002830	S.IC NJM2125F-TE1-#ZZZB	T	56.6/66.7
IC38	1110006380	S.IC LM2904PWR	T	114.1/23.8
IC39	1180001071	S.IC TA7805F(TE16L,Q)	T	101.2/24.3
IC40	1110005330	S.IC NJM12904V-TE1-#ZZZB	B	50.6/57.2
IC41	1180001251	S.IC TA7808F(TE16L,Q)	B	132/16.7
Q1	1590003230	S.TRA UNR9113J-(TX)	B	53.4/79.7
Q2	1530002851	S.TRA 2SC4116-BL(TE85R,F)	B	34.9/77.7
Q3	1560001360	S.FET 2SK3019 TL	B	66.4/76.6
Q4	1560000541	S.FET 2SK880-Y(T5RICOM,F)	B	88.8/41.5
Q5	1560000541	S.FET 2SK880-Y(T5RICOM,F)	B	33.3/107.5
Q6	1560000541	S.FET 2SK880-Y(T5RICOM,F)	B	29.6/101.3
Q7	1530002601	S.TRA 2SC4215-O(TE85R,F)	B	72.9/92.5
Q8	1560000541	S.FET 2SK880-Y(T5RICOM,F)	B	92.7/47.7
Q9	1560001360	S.FET 2SK3019 TL	B	39.5/104.5
Q10	1530002851	S.TRA 2SC4116-BL(TE85R,F)	B	88.8/44.6
Q11	1530002851	S.TRA 2SC4116-BL(TE85R,F)	B	29.6/104.4
Q12	1590003230	S.TRA UNR9113J-(TX)	B	65.6/101.6
Q13	1530002851	S.TRA 2SC4116-BL(TE85R,F)	B	88.8/47.7
Q14	1530002851	S.TRA 2SC4116-BL(TE85R,F)	B	29.6/107.5
Q15	1530002851	S.TRA 2SC4116-BL(TE85R,F)	B	92.7/44.6
Q16	1530002851	S.TRA 2SC4116-BL(TE85R,F)	B	33.3/104.5
Q19	1530002601	S.TRA 2SC4215-O(TE85R,F)	B	63.2/106.8
Q20	1530002920	S.TRA 2SC4226-T1 R25	B	38.8/123.1
Q21	1530002920	S.TRA 2SC4226-T1 R25	B	39.6/114.5
Q22	1530002920	S.TRA 2SC4226-T1 R25	B	94.6/64.3
Q23	1530002920	S.TRA 2SC4226-T1 R25	B	95.2/55.4
Q24	1530003311	S.TRA 2SC5107-O(TE85R,F)	B	100.5/58.6
Q25	1530003311	S.TRA 2SC5107-O(TE85R,F)	B	44.9/116.2
Q26	1590001400	S.TRA XP1214(TX)	B	40.5/117.8
Q27	1590001400	S.TRA XP1214(TX)	B	96/59.6
Q28	1590003290	S.TRA UNR9213J-(TX)	B	93.3/59.6
Q29	1590003290	S.TRA UNR9213J-(TX)	T	57.2/41.9
Q30	1590003290	S.TRA UNR9213J-(TX)	B	37.8/117.8
Q31	1590003230	S.TRA UNR9113J-(TX)	T	57.2/39.8
Q32	1530003980	S.TRA 2SC5700WB-TR-E	B	46.5/109.1
Q33	1530003980	S.TRA 2SC5700WB-TR-E	B	102.1/53.4
Q34	1530003311	S.TRA 2SC5107-O(TE85R,F)	B	46.2/123.1
Q35	1530003311	S.TRA 2SC5107-O(TE85R,F)	B	101.9/64.4
Q36	1580000731	S.FET 3SK293(TE85L,F)	B	47.3/136.1
Q37	1530003311	S.TRA 2SC5107-O(TE85R,F)	B	132.5/84.5
Q38	1530002680	S.FET 2SC3357-T1	B	138.1/88.8
Q39	1560000841	S.FET 2SK1829(TE85R,F)	B	53.2/140.8
Q40	1590001190	S.TRA XP6501-(TX)AB	T	101.6/87.4
Q41	1520000460	S.TRA 2SB1132 T100 R	T	101.6/82.8
Q42	1590003290	S.TRA UNR9213J-(TX)	T	13.3/67.6
Q43	1590003290	S.TRA UNR9213J-(TX)	T	138.8/122.9
Q44	1590003290	S.TRA UNR9213J-(TX)	T	122.8/79.2
Q45	1540000550	S.TRA 2SD1664 T100Q	T	117/76.3
Q46	1530002851	S.TRA 2SC4116-BL(TE85R,F)	T	137.4/120.3
Q48	1510000920	S.TRA 2SA1577 T100 Q	T	101.5/77.8
Q49	1590003290	S.TRA UNR9213J-(TX)	T	102.2/73.7
Q52	1590003290	S.TRA UNR9213J-(TX)	T	10.9/131.6
Q53	1590003290	S.TRA UNR9213J-(TX)	T	10.9/129.6
Q56	1590003321	S.FET TPC6103(TE85L,F)	T	7.6/132.6
Q57	1550000190	S.FET 2SJ506STR-E	T	125.2/99.6
Q58	1590003290	S.TRA UNR9213J-(TX)	T	130.2/102.1
Q59	1590000990	S.TRA DTC363EK T146	T	7.6/127.6
Q61	1530002851	S.TRA 2SC4116-BL(TE85R,F)	T	6.8/118.4
Q62	1540000441	S.TRA 2SD1619T-TD-E	T	118.4/18.5
Q63	1560000990	S.FET PMBFJ310	B	66.3/110
Q64	1560000990	S.FET PMBFJ310	B	63.3/110

## [MAIN UNIT]

REF NO.	ORDER NO.	DESCRIPTION	M.	H/V LOCATION
Q65	1530003311	S.TRA 2SC5107-O(TE85R,F)	B	59.6/123.7
Q66	1590003290	S.TRA UNR9213J-(TX)	B	94.9/4.7
Q67	1590003290	S.TRA UNR9213J-(TX)	B	124.9/4.7
Q68	1590003290	S.TRA UNR9213J-(TX)	B	109.9/4.7
Q69	1590003290	S.TRA UNR9213J-(TX)	T	9.5/53.3
Q70	1590003230	S.TRA UNR9113J-(TX)	T	9.5/51
D1	1750001070	S.DIO DAN235ETL	B	57.3/78.6
D2	1750001070	S.DIO DAN235ETL	B	50/79.7
D3	1790001621	S.DIO 1SV308(TPL3,F)	B	70.3/93.4
D4	1790001621	S.DIO 1SV308(TPL3,F)	B	67.8/93.4
D7	1750001150	S.VAR HVC383BTRF-E	B	30.8/122.3
D8	1750001150	S.VAR HVC383BTRF-E	B	30.6/112.7
D9	1750001150	S.VAR HVC383BTRF-E	B	85.6/63.5
D10	1750001150	S.VAR HVC383BTRF-E	B	85.7/53.3
D11	1790001621	S.DIO 1SV308(TPL3,F)	B	63.5/103.1
D12	1790001621	S.DIO 1SV308(TPL3,F)	B	62.7/101.1
D13	1750000711	S.VAR HVC350BTRF-E	B	87.3/67.8
D14	1750000711	S.VAR HVC350BTRF-E	B	87.1/55.4
D15	1750000711	S.VAR HVC350BTRF-E	B	32.6/125.4
D16	1750000711	S.VAR HVC350BTRF-E	B	32/114.5
D17	1720000570	S.VAR MA368(TX)	B	94.6/66.6
D18	1720000570	S.VAR MA368(TX)	B	91.4/57.7
D19	1750000520	S.DIO DAN222TL	T	59.6/39.8
D20	1790001260	S.DIO MA2S077-(TX)	T	38.9/57.8
D21	1750000711	S.VAR HVC350BTRF-E	B	66.1/135.8
D22	1750000711	S.VAR HVC350BTRF-E	B	62.9/135.8
D24	1750000711	S.VAR HVC350BTRF-E	B	56.1/135.9
D27	1790001250	S.DIO MA2S111-(TX)	B	57.2/140.4
D28	1750000711	S.VAR HVC350BTRF-E	B	35.9/134.4
D29	1750000711	S.VAR HVC350BTRF-E	B	37.1/134.4
D31	1750000711	S.VAR HVC350BTRF-E	B	32.4/136.5
D32	1750000711	S.VAR HVC350BTRF-E	B	32.4/135.3
D33	1790001240	S.DIO MA2S728-(TX)	B	37.8/144.2
D34	1790001260	S.DIO MA2S077-(TX)	B	85.4/137.8
D38	1750001360	S.DIO L709CER (9401)	B	87.8/135.6
D40	1750000370	S.DIO DA221 TL	T	112.6/77
D44	1710001061	DIO L407CDB		
D45	1790001211	S.DIO 1SS375-TL-E	B	96.3/138.1
D46	1750000520	S.DIO DAN222TL	T	13.3/131.1
D47	1750000520	S.DIO DAN222TL	T	13.2/129.1
D48	1790000660	S.DIO MA728(TX)	B	121.1/142.5
D49	1790000660	S.DIO MA728(TX)	B	140.6/133
D51	1790001250	S.DIO MA2S111-(TX)	T	10.5/127.1
D53	1790001810	S.VAR AVR-M1005C080MTABB	T	32.5/11.5
D55	1790001810	S.VAR AVR-M1005C080MTABB	T	30.5/11.5
D56	1790001810	S.VAR AVR-M1005C080MTABB	B	33.2/22.5
D59	1790000700	DIO DSA3A1		
D61	1160000070	S.DIO DAN202K T146	T	118.4/14.3
D62	1750000431	S.DIO HSB88WSTR-E	B	68.3/123.3
D63	1790001250	S.DIO MA2S111-(TX)	B	34.1/20.7
D64	1750000370	S.DIO DA221 TL	T	63.2/93.9
D65	1750000370	S.DIO DA221 TL	T	65.2/93.9
D66	1750000370	S.DIO DA221 TL	T	67.2/93.9
D67	1750000370	S.DIO DA221 TL	T	62.5/105.6
D68	1750000370	S.DIO DA221 TL	T	60.5/104.7
D69	1750000370	S.DIO DA221 TL	T	69.2/93.9
D70	1750000370	S.DIO DA221 TL	T	71.2/93.9
D71	1750000370	S.DIO DA221 TL	T	69.4/109.5
D72	1750000370	S.DIO DA221 TL	T	71.5/109.5
D73	1750000370	S.DIO DA221 TL	T	73.5/109.5
D74	1750000370	S.DIO DA221 TL	T	75.6/109.5
D75	1790001250	S.DIO MA2S111-(TX)	B	41/38.6
D76	1790001250	S.DIO MA2S111-(TX)	B	26.4/41.3
D77	1790001250	S.DIO MA2S111-(TX)	B	49.2/29.9
D78	1730002360	S.ZEN MA8062-M(TX)	B	52.3/29.9
FI1	2020001520	CER CFWLA450KFFA-B0 (CFWS450F)		
FI2	2020001460	CER CFWLA450KHFA-B0 (CFWS450HT)		
FI3	2030000500	S.MON DSF753SFB 46.35 MHz(FL-401)	B	72/101
FI4	2030000670	S.MON DSF753SFB 46.35 MHz(FL-420)	B	63.4/91.1
FI5	2040001440	S.LC NFE31PT152Z1E9L (NFM60R20T152)	T	114.2/110.3
FI6	2040001440	S.LC NFE31PT152Z1E9L (NFM60R20T152)	T	114.2/113.4
FI7	2040001440	S.LC NFE31PT152Z1E9L (NFM60R20T152)	T	114.2/116.5
X1	6050012380	S.XTA CR-826 DSA535SD 15.3 MHz	B	128.6/45.3
X2	6050012380	S.XTA CR-826 DSA535SD 15.3 MHz	B	35.6/72.3
X3	6070000300	S.DIS JTBM450CX24 <J>	B	63.5/83.5
X4	6050012350	S.XTA CR-817 DSB321SC 12.288 MHz	B	52.8/38.2
X5	6050012680	S.XTA CR-858(SMD-49/18.432 MHz)	T	46.9/52.7
L1	6200004660	S.COI MLF1608A 1R8K-T	B	115.6/39.2
L2	6200004660	S.COI MLF1608A 1R8K-T	B	23.6/82.4
L3	6200004480	S.COI MLF1608D R82K-T	B	39.4/79.3
L4	6200003540	S.COI MLF1608D R22K-T	B	36.9/76.9
L5	6200005671	S.COI ELJRE 12NGFA [USA-01]	B	102.7/46.7
	6200005671	S.COI ELJRE 12NGFA [EXP-01]		
	6200005661	S.COI ELJRE 10NGFA [USA-02]		
	6200005661	S.COI ELJRE 10NGFA [EXP-02]		
	6200005671	S.COI ELJRE 12NGFA [EUR-01]		
L6	6200005671	S.COI ELJRE 12NGFA	B	44.6/99.3

M.=Mounted side (T: Mounted on the Top side, B: Mounted on the Bottom side)  
S.=Surface mount

## [MAIN UNIT]

REF NO.	ORDER NO.	DESCRIPTION	M.	H/V LOCATION
L8	6200004741	S.COI NLV25T-1R2J	B	28.5/121.7
L9	6200004741	S.COI NLV25T-1R2J	B	28.5/124.9
L10	6200004741	S.COI NLV25T-1R2J	B	28.5/114.1
L11	6200004741	S.COI NLV25T-1R2J	B	83.7/63.1
L12	6200004741	S.COI NLV25T-1R2J	B	83.7/54.6
L13	6200004741	S.COI NLV25T-1R2J	B	30.6/117.2
L14	6200004741	S.COI NLV25T-1R2J	B	84.2/66.2
L15	6200004741	S.COI NLV25T-1R2J	B	84.2/57.7
L18	6200009260	S.COI C3328A-5N0J-A	B	88.7/63.1
L19	6200009260	S.COI C3328A-5N0J-A	B	89.8/54
L20	6200009390	S.COI C3328A-8N0J-A	B	33.2/121.7
L21	6200009390	S.COI C3328A-8N0J-A	B	34.7/113.1
L22	6200003550	S.COI MLF1608A 4R7K-T	B	73.4/109.9
L23	6200002861	S.COI NLV25T-4R7J	B	57.6/108.9
L24	6200010740	S.COI C2520C-R27G-A	B	70/109.1
L25	6200004741	S.COI NLV25T-1R2J	B	97.1/64.6
L26	6200004741	S.COI NLV25T-1R2J	B	98.1/53.9
L27	6130002961	S.COI #617DB-1327=P3	B	68.3/117
L28	6200005711	S.COI ELJURE 27NGFA	B	62.3/123.6
L29	6200005721	S.COI ELJURE 33NGFA	B	102.6/58.6
L30	6200005721	S.COI ELJURE 33NGFA	B	46.9/116.2
L31	6200002861	S.COI NLV25T-4R7J	T	91.1/19.9
L32	6130002961	S.COI #617DB-1327=P3	B	68.3/128.7
L33	6200005671	S.COI ELJURE 12NGFA	B	47.3/107.1
L34	6200005711	S.COI ELJURE 27NGFA	[USA-01] B	61.1/117.5
	6200005711	S.COI ELJURE 27NGFA	[EXP-01]	
	6200005691	S.COI ELJURE 18NGFA	[USA-02]	
	6200005691	S.COI ELJURE 18NGFA	[EXP-02]	
	6200005711	S.COI ELJURE 27NGFA	[EUR-01]	
L35	6200005671	S.COI ELJURE 12NGFA	[USA-01] B	102.7/51.6
	6200005671	S.COI ELJURE 12NGFA	[EXP-01]	
	6200005661	S.COI ELJURE 10NGFA	[USA-02]	
	6200005661	S.COI ELJURE 10NGFA	[EXP-02]	
	6200005671	S.COI ELJURE 12NGFA	[EUR-01]	
L36	6200005711	S.COI ELJURE 27NGFA	B	44.3/123.1
L37	6200005711	S.COI ELJURE 27NGFA	[USA-01] B	61.1/120.1
	6200005711	S.COI ELJURE 27NGFA	[EXP-01]	
	6200005691	S.COI ELJURE 18NGFA	[USA-02]	
	6200005691	S.COI ELJURE 18NGFA	[EXP-02]	
	6200005711	S.COI ELJURE 27NGFA	[EUR-01]	
L38	6200005711	S.COI ELJURE 27NGFA	B	100/64.4
L39	6200009320	S.COI C3328A-12NG-A	B	70.8/137.3
L40	6200009320	S.COI C3328A-12NG-A	B	59.5/135.7
L41	6200009320	S.COI C3328A-12NG-A	B	51.4/136.3
L42	6200005711	S.COI ELJURE 27NGFA	B	134.7/83.8
L43	6200005711	S.COI ELJURE 27NGFA	B	142/87.1
L44	6200010290	S.COI C6328A-22NG-A	[USA-01] B	41.9/136.2
	6200010290	S.COI C6328A-22NG-A	[EXP-01]	
	6200013490	S.COI C6328A-17NG-A	[USA-02]	
	6200013490	S.COI C6328A-17NG-A	[EXP-02]	
	6200010290	S.COI C6328A-22NG-A	[EUR-01]	
L45	6200005641	S.COI ELJURE 6N8ZF	B	142.7/90.6
L46	6200005691	S.COI ELJURE 18NGFA	[USA-01] B	142/94.6
	6200005691	S.COI ELJURE 18NGFA	[EXP-01]	
	6200005691	S.COI ELJURE 18NGFA	[USA-02]	
	6200005691	S.COI ELJURE 18NGFA	[EXP-02]	
	6200005671	S.COI ELJURE 12NGFA	[EUR-01]	
L47	6200010290	S.COI C6328A-22NG-A	[USA-01] B	34.8/140.3
	6200010290	S.COI C6328A-22NG-A	[EXP-01]	
	6200013490	S.COI C6328A-17NG-A	[USA-02]	
	6200013490	S.COI C6328A-17NG-A	[EXP-02]	
	6200010290	S.COI C6328A-22NG-A	[EUR-01]	
L48	6200010100	S.COI C2012C-33NG-A	B	39.7/142.2
L49	6200010040	S.COI AS100340-10N	B	95.5/119.7
L50	6200005691	S.COI ELJURE 18NGFA	B	88/137.7
L52	6200010420	S.COI FHW1210HC 1R0JGT <JJE>	B	86.6/122.3
L53	6200010150	S.COI AS080340-15N	B	92.5/134.3
L54	6200010150	S.COI AS080340-15N	B	99.7/133.8
L55	6200010150	S.COI AS080340-15N	B	107.5/135.8
L56	6200010150	S.COI AS080340-15N	B	114.4/138.9
L57	6200010150	S.COI AS080340-15N	B	144.6/142.1
L58	6200002861	S.COI NLV25T-4R7J	T	55.4/37.5
L59	6200010420	S.COI FHW1210HC 1R0JGT <JJE>	B	147.1/146.2
L60	6200010420	S.COI FHW1210HC 1R0JGT <JJE>	B	24.5/145
L61	6200002961	S.COI NLV32T-4R7J	T	118.4/23.8
L65	6200004741	S.COI NLV25T-1R2J	B	41.3/123.3
L66	6200004741	S.COI NLV25T-1R2J	B	42.8/113.5
R1	7030005700	S.RES ERJ2GEJ 274 X (270K)	T	54.5/63.5
R2	7030005050	S.RES ERJ2GEJ 103 X (10K)	T	59/61.8
R3	7030005240	S.RES ERJ2GEJ 473 X (47K)	T	62.4/69.6
R4	7030007340	S.RES ERJ2GEJ 153 X (15K)	B	57.3/80.1
R6	7030007300	S.RES ERJ2GEJ 332 X (3.3K)	T	9.5/57.1
R7	7030010040	S.RES ERJ2GEJ-JPW	T	61.6/66.3
R8	7030005160	S.RES ERJ2GEJ 105 X (1M)	T	24.9/70.4
R9	7030005160	S.RES ERJ2GEJ 105 X (1M)	T	25.8/70.4
R10	7030005160	S.RES ERJ2GEJ 105 X (1M)	T	26.7/70.4
R12	7510001730	S.THE ERTJJOEP 473J	B	129.1/49.3
R13	7030005090	S.RES ERJ2GEJ 104 X (100K)	B	130.8/49.3
R15	7030007340	S.RES ERJ2GEJ 153 X (15K)	B	54.5/78.3
R17	7030004980	S.RES ERJ2GEJ 101 X (100)	T	19.8/68.8
R18	7030007340	S.RES ERJ2GEJ 153 X (15K)	B	55.3/79.2
R20	7030008300	S.RES ERJ2GEJ 184 X (180K)	T	56.2/63.5
R22	7410001130	S.ARR EXB28V102JX	B	122.6/39
R23	7410001130	S.ARR EXB28V102JX	B	23.1/76.3
R25	7030004970	S.RES ERJ2GEJ 470 X (47)	B	65.3/79.4
R26	7030010040	S.RES ERJ2GEJ-JPW	T	57.8/64.5
R27	7030005120	S.RES ERJ2GEJ 102 X (1K)	T	57.8/51
R29	7030007570	S.RES ERJ2GEJ 122 X (1.2K)	B	35.8/75.5
R30	7030007340	S.RES ERJ2GEJ 153 X (15K)	B	52.8/81.1
R32	7030007340	S.RES ERJ2GEJ 153 X (15K)	B	51.2/78.3
R33	7030007340	S.RES ERJ2GEJ 153 X (15K)	B	48.4/78.2
R34	7030005240	S.RES ERJ2GEJ 473 X (47K)	T	27.1/68.1

## [MAIN UNIT]

REF NO.	ORDER NO.	DESCRIPTION	M.	H/V LOCATION
R35	7030005240	S.RES ERJ2GEJ 473 X (47K)	T	28/68.1
R36	7030005240	S.RES ERJ2GEJ 473 X (47K)	T	28.9/68.1
R38	7030005230	S.RES ERJ2GEJ 334 X (330K)	T	27.6/70.4
R39	7030005230	S.RES ERJ2GEJ 334 X (330K)	T	28.6/70.4
R40	7030005230	S.RES ERJ2GEJ 334 X (330K)	T	29.5/70.4
R41	7030005240	S.RES ERJ2GEJ 473 X (47K)	B	68.2/78.2
R42	7030007060	S.RES ERJ2GEJ 684X (680K)	B	34.6/75.9
R43	7030007290	S.RES ERJ2GEJ 222 X (2.2K)	B	62.8/77.3
R44	7030005030	S.RES ERJ2GEJ 152 X (1.5K)	B	71.4/78.2
R45	7030004970	S.RES ERJ2GEJ 470 X (47)	B	64.6/75.5
R46	7030005000	S.RES ERJ2GEJ 471 X (470)	T	52.7/57.1
R47	7030005290	S.RES ERJ2GEJ 682 X (6.8K)	B	64.6/76.4
R48	7030005030	S.RES ERJ2GEJ 152 X (1.5K)	B	62.8/76.4
R49	7030010040	S.RES ERJ2GEJ-JPW	T	55.2/57
R52	7030004980	S.RES ERJ2GEJ 101 X (100)	B	34.1/56.4
R53	7030005210	S.RES ERJ2GEJ 822 X (8.2K)	B	16.8/57.6
R54	7030005000	S.RES ERJ2GEJ 471 X (470)	B	19.4/64.3
R56	7030004970	S.RES ERJ2GEJ 470 X (47)	B	121.9/50.4
R57	7030005040	S.RES ERJ2GEJ 472 X (4.7K)	B	62.8/75.5
R58	7030008290	S.RES ERJ2GEJ 183 X (18K)	B	56.5/49.8
R59	7030008290	S.RES ERJ2GEJ 183 X (18K)	B	57.4/49
R60	7030005000	S.RES ERJ2GEJ 471 X (470)	B	33.1/75.2
R62	7030005120	S.RES ERJ2GEJ 102 X (1K)	T	18.5/62.5
R63	7030005090	S.RES ERJ2GEJ 104 X (100K)	T	55.5/60
R65	7030005000	S.RES ERJ2GEJ 471 X (470)	B	125.1/47.3
R66	7030004980	S.RES ERJ2GEJ 101 X (100)	B	56.5/50.6
R68	7030005040	S.RES ERJ2GEJ 472 X (4.7K)	B	67.5/86.7
R69	7030005120	S.RES ERJ2GEJ 102 X (1K)	B	32.7/83
R71	7030005240	S.RES ERJ2GEJ 473 X (47K)	B	31/62.6
R72	7030004980	S.RES ERJ2GEJ 101 X (100)	B	57.6/44.2
R75	7030005110	S.RES ERJ2GEJ 224 X (220K)	B	39.9/71.1
R76	7030005120	S.RES ERJ2GEJ 102 X (1K)	B	91/41.5
R77	7030005580	S.RES ERJ2GEJ 560 X (56)	B	119.7/48.8
R78	7030005120	S.RES ERJ2GEJ 102 X (1K)	B	29.6/99.3
R79	7030005580	S.RES ERJ2GEJ 560 X (56)	B	32.7/79.5
R80	7030004970	S.RES ERJ2GEJ 470 X (47)	B	23.5/41.1
R81	7030007250	S.RES ERJ2GEJ 220 X (22)	B	49.9/50.5
R82	7030008400	S.RES ERJ2GEJ 182 X (1.8K)	B	56/44.2
R84	7030007290	S.RES ERJ2GEJ 222 X (2.2K)	B	95.4/45.4
R85	7030007290	S.RES ERJ2GEJ 222 X (2.2K)	B	36.9/105.6
R87	7030005090	S.RES ERJ2GEJ 104 X (100K)	B	73.7/81.1
R88	7030005530	S.RES ERJ2GEJ 100 X (10)	B	39/71.1
R89	7030008400	S.RES ERJ2GEJ 182 X (1.8K)	B	67.1/83.2
R90	7030008010	S.RES ERJ2GEJ 123 X (12K)	T	54.5/73.3
R91	7030007570	S.RES ERJ2GEJ 122 X (1.2K)	B	94.5/45.4
R92	7030005290	S.RES ERJ2GEJ 682 X (6.8K)	B	86.7/51.9
R93	7030007570	S.RES ERJ2GEJ 122 X (1.2K)	B	35.1/105.6
R94	7030005290	S.RES ERJ2GEJ 682 X (6.8K)	B	28/93.3
R97	7410001170	S.ARR EXB28V470JX	B	42.9/49.9
R98	7030005530	S.RES ERJ2GEJ 100 X (10)	B	70.7/90.4
R99	7030005110	S.RES ERJ2GEJ 224 X (220K)	B	70.7/91.3
R100	7030005600	S.RES ERJ2GEJ 273 X (27K)	B	69.1/92.3
R101	7030004980	S.RES ERJ2GEJ 101 X (100)	B	86.7/43.7
R102	7030004980	S.RES ERJ2GEJ 101 X (100)	B	31.5/105.6
R103	7030004980	S.RES ERJ2GEJ 101 X (100)	B	27.8/103.9
R104	7030005050	S.RES ERJ2GEJ 103 X (10K)	B	86.7/45.4
R105	7030005050	S.RES ERJ2GEJ 103 X (10K)	B	31.5/109
R106	7030005050	S.RES ERJ2GEJ 103 X (10K)	B	27.8/105.6
R107	7030004980	S.RES ERJ2GEJ 101 X (100)	B	90.8/45.4
R108	7030005030	S.RES ERJ2GEJ 152 X (1.5K)	B	90.8/43.7
R109	7030005090	S.RES ERJ2GEJ 104 X (100K)	B	65.7/100.1
R110	7030005810	S.RES RR0510P-152-D (1.5K)	B	31.5/103.9
R111	7030005090	S.RES ERJ2GEJ 104 X (100K)	B	37.8/105.6
R112	7030005220	S.RES ERJ2GEJ 223 X (22K)	B	86.7/47.1
R113	7030005220	S.RES ERJ2GEJ 223 X (22K)	B	27.8/107.3
R114	7030007300	S.RES ERJ2GEJ 332 X (3.3K)	B	69.4/94.8
R115	7030007300	S.RES ERJ2GEJ 332 X (3.3K)	B	66.8/96.2
R116	7030005050	S.RES ERJ2GEJ 103 X (10K)	B	90.8/48.8
R117	7030005120	S.RES ERJ2GEJ 102 X (1K)	B	90.8/47.1
R118	7030007280	S.RES ERJ2GEJ 301 X (30)	B	72.8/94.8
R119	7030007270	S.RES ERJ2GEJ 151 X (150)	B	67.2/90
R120	7030005800	S.RES RR0510P-102-D (1K)	B	31.5/107.3
R121	7030009820	S.RES RR0510P-681-D (680)	B	26.2/109
R122	7030004970	S.RES ERJ2GEJ 470 X (47)	B	56.6/33.9
R123	7030004970	S.RES ERJ2GEJ 470 X (47)	B	49.5/38.5
R124	7030005240	S.RES ERJ2GEJ 473 X (47K)	B	55.3/38.3
R125	7030007280	S.RES ERJ2GEJ 331 X (330)	B	82.6/51
R126	7030007290	S.RES ERJ2GEJ 222 X (2.2K)	B	94.5/43.7
R127	7030005700	S.RES ERJ2GEJ 274 X (270K)	T	61.2/51
R128	7030007290	S.RES ERJ2GEJ 222 X (2.2K)	T	35.1/103.9
R129	7030005240	S.RES ERJ2GEJ 473 X (47K)	B	55.3/35.1
R130	7030005240	S.RES ERJ2GEJ 473 X (47K)	B	56.2/36.7
R131	7030004980	S.RES ERJ2GEJ 101 X (100)	B	54.2/32.4
R132	7030007290	S.RES ERJ2GEJ 222 X (2.2K)	B	50.8/34.9
R133	7030007280	S.RES ERJ2GEJ 331 X (330)	B	67.5/104.4
R134	7030007270	S.RES ERJ2GEJ 151 X (150)	B	62.7/97.1
R136	7030005110	S.RES ERJ2GEJ 224 X (220K)	B	81.7/65.3
R13				



[MAIN UNIT]

REF NO.	ORDER NO.	DESCRIPTION	M.	H/V LOCATION
R157	7030005530	S.RES ERJ2GEJ 100 X (10)	B	92.4/66.6
R158	7030005530	S.RES ERJ2GEJ 100 X (10)	B	88.9/57.2
R159	7030005530	S.RES ERJ2GEJ 100 X (10)	B	65.2/106.1
R160	7030010040	S.RES ERJ2GEJ-JPW	B	36.8/123.7
R161	7030006020	S.RES RR0510P-682-D (6.8K)	B	37.6/113.5
R162	7030010040	S.RES ERJ2GEJ-JPW	B	37.6/115.3
R163	7030006020	S.RES RR0510P-682-D (6.8K)	B	92.4/62
R164	7030006020	S.RES RR0510P-682-D (6.8K)	B	92.7/52.9
R165	7030009320	S.RES ERJ2GEJ 4R7 X (4.7)	B	92.4/65.2
R166	7030009320	S.RES ERJ2GEJ 4R7 X (4.7)	B	93.1/56.3
R167	7030007250	S.RES ERJ2GEJ 220 X (22)	B	58.3/111.1
R168	7030006020	S.RES RR0510P-682-D (6.8K)	B	92.4/63.4
R169	7030006020	S.RES RR0510P-682-D (6.8K)	B	93.1/54.5
R171	7030011920	S.RES RR0510P-561-D (560)	B	41/120.7
R172	7030009820	S.RES RR0510P-681-D (680)	B	97/62
R173	7030009820	S.RES RR0510P-681-D (680)	B	97/56.5
R174	7030009820	S.RES RR0510P-681-D (680)	B	41.4/115.7
R175	7030005530	S.RES ERJ2GEJ 100 X (10)	B	73.6/108.8
R176	7030005310	S.RES ERJ2GEJ 124 X (120K)	B	100.5/56.8
R177	7030005310	S.RES ERJ2GEJ 124 X (120K)	B	44.9/114.4
R178	7030004980	S.RES ERJ2GEJ 101 X (100)	B	100.5/55.9
R179	7030004980	S.RES ERJ2GEJ 101 X (100)	B	44.9/113.5
R180	7030005050	S.RES ERJ2GEJ 103 X (10K)	B	36/109
R181	7030005050	S.RES ERJ2GEJ 103 X (10K)	B	95.4/48.8
R182	7030007300	S.RES ERJ2GEJ 332 X (3.3K)	B	68.5/107
R185	7030010040	S.RES ERJ2GEJ-JPW	B	62.3/117.5
R186	7030005120	S.RES ERJ2GEJ 102 X (1K)	T	39.2/50.7
R187	7030008010	S.RES ERJ2GEJ 123 X (12K)	T	41.5/55.9
R188	7410001150	S.ARR EXB28V471JX	T	48.5/41.1
R189	7030005090	S.RES ERJ2GEJ 104 X (100K)	T	55.6/39.5
R190	7030008010	S.RES ERJ2GEJ 123 X (12K)	T	43.1/55.9
R191	7030005000	S.RES ERJ2GEJ 471 X (470)	B	44/109.1
R192	7030005110	S.RES ERJ2GEJ 224 X (220K)	B	44.9/109.1
R194	7030004980	S.RES ERJ2GEJ 101 X (100)	B	100.5/51.7
R195	7030005110	S.RES ERJ2GEJ 224 X (220K)	B	100.5/53.4
R196	7030007260	S.RES ERJ2GEJ 330 X (33)	B	48/120.7
R197	7030005050	S.RES ERJ2GEJ 103 X (10K)	T	40.5/50.6
R198	7030007260	S.RES ERJ2GEJ 330 X (33)	B	103.7/62
R199	7030005050	S.RES ERJ2GEJ 103 X (10K)	T	67.6/57.5
R200	7030004980	S.RES ERJ2GEJ 101 X (100)	B	43.1/122.6
R201	7030005070	S.RES ERJ2GEJ 683 X (68K)	B	48/122.6
R202	7030005160	S.RES ERJ2GEJ 105 X (1M)	T	41.4/48.6
R204	7030005050	S.RES ERJ2GEJ 103 X (10K)	T	54.7/39.5
R205	7030008010	S.RES ERJ2GEJ 123 X (12K)	T	34.5/57.9
R207	7030005070	S.RES ERJ2GEJ 683 X (68K)	B	103.7/64
R208	7030010040	S.RES ERJ2GEJ-JPW	B	46.2/120.7
R209	7030005000	S.RES ERJ2GEJ 471 X (470)	T	67.6/56
R212	7410001140	S.ARR EXB28V104JX	T	52.3/41.1
R213	7030005530	S.RES ERJ2GEJ 100 X (10)	T	41.4/47.7
R214	7030004980	S.RES ERJ2GEJ 101 X (100)	B	98.9/64
R215	7030010040	S.RES ERJ2GEJ-JPW	B	100.9/62
R216	7410001140	S.ARR EXB28V104JX	T	17.3/52.4
R217	7410001140	S.ARR EXB28V104JX	T	38.6/56
R218	7030005110	S.RES ERJ2GEJ 224 X (220K)	B	65/137.9
R220	7410001140	S.ARR EXB28V104JX	T	15.2/50.7
R222	7410001140	S.ARR EXB28V104JX	T	36.1/56
R223	7030005050	S.RES ERJ2GEJ 103 X (10K)	B	64/136.3
R224	7410001150	S.ARR EXB28V471JX	T	30.4/53.1
R225	7030005110	S.RES ERJ2GEJ 224 X (220K)	B	64/137.9
R226	7030005110	S.RES ERJ2GEJ 224 X (220K)	B	57.2/136.1
R227	7410001150	S.ARR EXB28V471JX	T	42.9/28.9
R230	7410001150	S.ARR EXB28V471JX	T	28.6/50.9
R231	7030005010	S.RES ERJ2GEJ 681 X (680)	[USA-01] B	55/138
	7030005010	S.RES ERJ2GEJ 681 X (680)	[EXP-01]	
	7030005010	S.RES ERJ2GEJ 681 X (680)	[USA-02]	
	7030005010	S.RES ERJ2GEJ 681 X (680)	[EXP-02]	
	7030007280	S.RES ERJ2GEJ 331 X (330)	[EUR-01]	
R232	7410001150	S.ARR EXB28V471JX	T	25.9/49.4
R233	7030005530	S.RES ERJ2GEJ 100 X (10)	B	54.1/136.1
R234	7410001150	S.ARR EXB28V471JX	T	42.5/25.7
R235	7410001150	S.ARR EXB28V471JX	T	24.2/47.6
R236	7030005090	S.RES ERJ2GEJ 104 X (100K)	B	133.1/82.8
R237	7030004970	S.RES ERJ2GEJ 470 X (47)	B	48.4/138.3
R238	7410001150	S.ARR EXB28V471JX	T	45.7/28.9
R239	7410001150	S.ARR EXB28V471JX	T	22.4/45.8
R240	7030004980	S.RES ERJ2GEJ 101 X (100)	B	135.8/84.5
R241	7030005710	S.RES ERJ2GEJ 121 X (120)	B	48.4/133.8
R242	7030009320	S.RES ERJ2GEJ 4R7 X (4.7)	B	47.4/138.3
R243	7030005090	S.RES ERJ2GEJ 104 X (100K)	B	46.4/138.3
R244	7410001150	S.ARR EXB28V471JX	T	39.7/25.8
R245	7410001150	S.ARR EXB28V471JX	T	20.2/42.4
R246	7030005240	S.RES ERJ2GEJ 473 X (47K)	B	44.4/136.1
R247	7030008290	S.RES ERJ2GEJ 183 X (18K)	B	47.4/140.4
R248	7030005600	S.RES ERJ2GEJ 273 X (27K)	B	137.4/85.8
R253	7030004970	S.RES ERJ2GEJ 470 X (47)	B	138.8/85.4
R255	7030008400	S.RES ERJ2GEJ 182 X (1.8K)	B	51.4/140.4
R257	7410001140	S.ARR EXB28V104JX	T	14.5/45.7
R258	7030005110	S.RES ERJ2GEJ 224 X (220K)	B	58.3/140.4
R259	7030005170	S.RES ERJ2GEJ 474 X (470K)	B	56.1/140.4
R260	7030005050	S.RES ERJ2GEJ 103 X (10K)	T	144.6/121.4
R261	7030005050	S.RES ERJ2GEJ 103 X (10K)	T	52.5/25.2
R262	7030005090	S.RES ERJ2GEJ 104 X (100K)	T	51.9/22.8
R263	7410001140	S.ARR EXB28V104JX	T	46.2/20
R264	7410001140	S.ARR EXB28V104JX	T	50.2/24
R265	7030007280	S.RES ERJ2GEJ 331 X (330)	T	143/121.4
R266	7030005090	S.RES ERJ2GEJ 104 X (100K)	B	34.6/133.5
R267	7410001140	S.ARR EXB28V104JX	T	14.8/43.1
R268	7410001150	S.ARR EXB28V471JX	T	45.7/31.8
R269	7030007270	S.RES ERJ2GEJ 151 X (150)	B	142.6/92.6
R270	7030005050	S.RES ERJ2GEJ 103 X (10K)	B	30.6/134
R271	7030005090	S.RES ERJ2GEJ 104 X (100K)	T	23.8/26.7
R272	7410001150	S.ARR EXB28V471JX	T	17.9/32.3
R273	7410001150	S.ARR EXB28V471JX	T	17.9/35.1
R274	7030005090	S.RES ERJ2GEJ 104 X (100K)	B	31.5/134

[MAIN UNIT]

REF NO.	ORDER NO.	DESCRIPTION	M.	H/V LOCATION
R277	7030004980	S.RES ERJ2GEJ 101 X (100)	T	143.4/126.6
R278	7030005090	S.RES ERJ2GEJ 104 X (100K)	T	13.9/85.6
R279	7030007290	S.RES ERJ2GEJ 222 X (2.2K)	T	103.6/68.4
R280	7030004990	S.RES ERJ2GEJ 221 X (220)	T	138.4/128.2
R281	7410001150	S.ARR EXB28V471JX	T	21.3/31.8
R282	7030005090	S.RES ERJ2GEJ 104 X (100K)	T	37.8/20.3
R283	7030005100	S.RES ERJ2GEJ 154 X (150K)	T	141.5/126.6
R285	7030005050	S.RES ERJ2GEJ 103 X (10K)	T	101.6/79.5
R287	7410001140	S.ARR EXB28V104JX	T	49.7/27.7
R288	7030005110	S.RES ERJ2GEJ 224 X (220K)	T	136.8/124.7
R289	7030006070	S.RES ERJ2YJ101U (100)	B	86.9/117.5
R290	7030005110	S.RES ERJ2GEJ 224 X (220K)	T	137.2/122.6
R291	7030005040	S.RES ERJ2GEJ 472 X (4.7K)	T	139.2/121.2
R292	7030005050	S.RES ERJ2GEJ 103 X (10K)	T	139.3/128.2
R295	7030006610	S.RES ERJ2GEJ 394 X (390K)	T	136.3/122.6
R296	7030007300	S.RES ERJ2GEJ 332 X (3.3K)	T	121.8/77.2
R297	7030007300	S.RES ERJ2GEJ 332 X (3.3K)	T	122.8/77.2
R298	7030000440	S.RES MCR10EZJH 3.3K (332)	T	120.4/77.3
R299	7030004980	S.RES ERJ2GEJ 101 X (100)	B	29.1/19.4
R300	7030005530	S.RES ERJ2GEJ 100 X (10)	T	47.6/73.1
R301	7030008300	S.RES ERJ2GEJ 184 X (180K)	B	85.7/131
R303	7410001150	S.ARR EXB28V471JX	T	47.7/68.4
R304	7030005050	S.RES ERJ2GEJ 103 X (10K)	B	95.4/135.9
R306	7520000260	S.POS PRF18BB471QB1RB	B	87.3/130.2
R308	7030008010	S.RES ERJ2GEJ 123 X (12K)	[USA-01] T	140.7/128.3
	7030008010	S.RES ERJ2GEJ 123 X (12K)	[EXP-01]	
	7030008010	S.RES ERJ2GEJ 123 X (12K)	[USA-02]	
	7030008010	S.RES ERJ2GEJ 123 X (12K)	[EXP-02]	
	7030007340	S.RES ERJ2GEJ 153 X (15K)	[EUR-01]	
R309	7030005040	S.RES ERJ2GEJ 472 X (4.7K)	T	102.2/75.7
R313	7030005050	S.RES ERJ2GEJ 103 X (10K)	T	103.5/77.8
R315	7030005700	S.RES ERJ2GEJ 274 X (270K)	B	98.6/137.3
R316	7030005050	S.RES ERJ2GEJ 103 X (10K)	T	11.2/128.2
R320	7030005090	S.RES ERJ2GEJ 104 X (100K)	T	15/124.1
R321	7030003320	S.RES ERJ3GEYJ 101 V (100)	B	119.5/142.1
R322	7030007350	S.RES ERJ2GEJ 393 X (39K)	B	119.4/144.2
R324	7030005050	S.RES ERJ2GEJ 103 X (10K)	B	31.3/12
R325	7030005120	S.RES ERJ2GEJ 102 X (1K)	B	32.3/12
R326	7030005240	S.RES ERJ2GEJ 473 X (47K)	T	13.2/125.7
R327	7030000220	S.RES MCR10EZJH 47 (470)	B	119.7/132.8
R328	7030000260	S.RES MCR10EZJH 100 (101)	B	139.3/144.3
R331	7030004980	S.RES ERJ2GEJ 101 X (100)	T	12/120
R332	7030003320	S.RES ERJ3GEYJ 101 V (100)	B	139.5/135
R333	7030007350	S.RES ERJ2GEJ 393 X (39K)	B	139.3/131.4
R334	7030005651	S.RES ERA3YKD 304V (300K)	T	57.8/30.5
R335	7030005871	S.RES ERA3YKD 104V (100K)	T	55.9/28.7
R336	7030005110	S.RES ERJ2GEJ 224 X (220K)	T	12/120.9
R337	7030005110	S.RES ERJ2GEJ 224 X (220K)	T	13.2/120.6
R339	7030005090	S.RES ERJ2GEJ 104 X (100K)	T	12/125.3
R341	7030005050	S.RES ERJ2GEJ 103 X (10K)	B	33.3/12
R342	7030005090	S.RES ERJ2GEJ 104 X (100K)	B	45.3/56.9
R346	7410001150	S.ARR EXB28V471JX	T	43.5/73.8
R347	7030005000	S.RES ERJ2GEJ 471 X (470)	T	9.8/132.9
R348	7030000620	S.RES MCR10EZJH 100 K (104)	B	147.2/150.9
R349	7030000620	S.RES MCR10EZJH 100 K (104)	B	26/149.7
R350	7030003560	S.RES ERJ3GEYJ 103 V (10K)	B	6.4/131
R352	7030005040	S.RES ERJ2GEJ 472 X (4.7K)	T	10.2/125.3
R353	7030005240	S.RES ERJ2GEJ 473 X (47K)	B	55.8/56.9
R354	7030005700	S.RES ERJ2GEJ 274 X (270K)	T	125.2/103.6
R355	7030005090	S.RES ERJ2GEJ 104 X (100K)	T	129.2/103.6
R356	7030005050	S.RES ERJ2GEJ 103 X (10K)	T	9.8/134.5
R357	7030003560	S.RES ERJ3GEYJ 103 V (10K)	B	10.1/150.2
R362	7540000290	ABS ERZV10D220		
R364	7030005110	S.RES ERJ2GEJ 224 X (220K)	T	65.1/71.2
R365	7030005050	S.RES ERJ2GEJ 103 X (10K)	T	7.4/120.7
R366	7030007290	S.RES ERJ2GEJ 222 X (2.2K)	T	7/123.5
R367	7030004980	S.RES ERJ2GEJ 101 X (100)	T	9.7/117.3
R368	7030008300	S.RES ERJ2GEJ 184 X (180K)	T	8.5/117.8
R369	7030005230	S.RES ERJ2GEJ 334 X (330K)	T	9.7/118.2
R370	7030008280	S.RES ERJ2GEJ 271 X (270)	T	6.1/120.7
R371	7030010040	S.RES ERJ2GEJ-JPW	T	5/117.3
R372	7030005000	S.RES ERJ2GEJ 471 X (470)	T	115.3/15.8
R373	7030005050	S.RES ERJ2GEJ 103 X (10K)	T	115.3/14
R374	7030000140	S.RES MCR10EZJH 10 (100)	T	111.2/12.3
R375	7030010040	S.RES ERJ2GEJ-JPW	T	100.1/16.3
R376	7030004980	S.RES ERJ2GEJ 101 X (100)	B	62.3/122.2
R377	7030005000	S.RES ERJ2GEJ 471 X (470)	B	62.3/124.7
R378	7030005210	S.RES ERJ2GEJ 822 X (8.2K)	B	63.2/126.1
R379	7030005210	S.RES ERJ2GEJ 822 X (8.2		



[MAIN UNIT]

REF NO.	ORDER NO.	DESCRIPTION	M.	H/V LOCATION
R448	7030005090	S.RES ERJ2GEJ 104 X (100K)	T	49.3/19.2
R449	7030005170	S.RES ERJ2GEJ 474 X (470K)	T	39.5/19.2
R450	7030005050	S.RES ERJ2GEJ 103 X (10K)	T	50.2/16.5
R453	7030005120	S.RES ERJ2GEJ 102 X (1K)	T	52/13.9
R454	7030005120	S.RES ERJ2GEJ 102 X (1K)	B	94.9/2.7
R455	7030005010	S.RES ERJ2GEJ 681 X (680)	B	124.9/2.7
R456	7030005120	S.RES ERJ2GEJ 102 X (1K)	B	109.9/2.7
R467	7030005240	S.RES ERJ2GEJ 473 X (47K)	B	38/44.6
R468	7410001140	S.ARR EXB28V104JX	B	31.8/48.5
R469	7030005090	S.RES ERJ2GEJ 104 X (100K)	B	32.6/44.6
R470	7030005090	S.RES ERJ2GEJ 104 X (100K)	T	10.9/20.2
R471	7030005090	S.RES ERJ2GEJ 104 X (100K)	B	47.7/44.2
R472	7030005240	S.RES ERJ2GEJ 473 X (47K)	B	46/36.1
R473	7030005090	S.RES ERJ2GEJ 104 X (100K)	B	46.2/44.6
R474	7030005530	S.RES ERJ2GEJ 100 X (10)	B	15.5/55.3
R475	7030005240	S.RES ERJ2GEJ 473 X (47K)	B	9/56.2
R476	7030005090	S.RES ERJ2GEJ 104 X (100K)	B	15/53.5
R477	7030005080	S.RES ERJ2GEJ 823 X (82K)	B	15/52.6
R478	7030005050	S.RES ERJ2GEJ 103 X (10K)	B	9.1/54.7
R479	7030005110	S.RES ERJ2GEJ 224 X (220K)	T	64.2/69.6
R480	7030005050	S.RES ERJ2GEJ 103 X (10K)	B	15.6/61.5
R481	7030005050	S.RES ERJ2GEJ 103 X (10K)	B	16.5/59.9
R482	7410001150	S.ARR EXB28V471JX	T	19.6/45.1
R483	7030005090	S.RES ERJ2GEJ 104 X (100K)	T	31.2/56.5
R484	7030005090	S.RES ERJ2GEJ 104 X (100K)	B	28.8/50.9
R485	7410001150	S.ARR EXB28V471JX	T	67.3/96.9
R486	7410001150	S.ARR EXB28V471JX	T	64.8/105.4
R487	7410001150	S.ARR EXB28V471JX	T	72.8/105.4
R488	7030008400	S.RES ERJ2GEJ 182 X (1.8K)	T	9.5/54.9
R489	7030004980	S.RES ERJ2GEJ 101 X (100)	B	24.1/58.7
R490	7030008290	S.RES ERJ2GEJ 183 X (18K)	B	28.2/58.4
R491	7030004980	S.RES ERJ2GEJ 101 X (100)	B	26.1/51.2
R492	7030005240	S.RES ERJ2GEJ 473 X (47K)	B	29.8/58.8
R493	7030010040	S.RES ERJ2GEJ-JPW	T	11.3/19
R494	7030005000	S.RES ERJ2GEJ 471 X (470)	T	73.2/98.2
R495	7030005100	S.RES ERJ2GEJ 154 X (150K)	T	55.2/55.3
R496	7030005070	S.RES ERJ2GEJ 683 X (68K)	T	52.7/56.2
R497	7030005700	S.RES ERJ2GEJ 274 X (270K)	T	52.7/55.3
R498	7030005600	S.RES ERJ2GEJ 273 X (27K)	B	61.4/103.1
R499	7030004980	S.RES ERJ2GEJ 101 X (100)	T	24.4/57
R500	7030005600	S.RES ERJ2GEJ 273 X (27K)	T	21.2/57.5
R501	7030005220	S.RES ERJ2GEJ 223 X (22K)	T	22.8/53.8
R502	7030005090	S.RES ERJ2GEJ 104 X (100K)	T	28/55
R503	7030007350	S.RES ERJ2GEJ 393 X (39K)	T	55.5/58.4
R505	7030010040	S.RES ERJ2GEJ-JPW	T	113.4/18.3
R506	7030005110	S.RES ERJ2GEJ 224 X (220K)	T	113.4/19.3
R507	7030005090	S.RES ERJ2GEJ 104 X (100K)	T	115/19.3
R508	7030010040	S.RES ERJ2GEJ-JPW	T	144.6/119.6
R509	7030005050	S.RES ERJ2GEJ 103 X (10K)	B	33.3/15.2
R510	7030007350	S.RES ERJ2GEJ 393 X (39K)	B	29/14.1
R511	7030005050	S.RES ERJ2GEJ 103 X (10K)	B	29.1/18.5
R512	7030005050	S.RES ERJ2GEJ 103 X (10K)	B	30.8/18.5
R513	7030007280	S.RES ERJ2GEJ 331 X (330)	B	72.3/90.4
R530	7030005240	S.RES ERJ2GEJ 473 X (47K)	T	62.5/66.3
R531	7030007290	S.RES ERJ2GEJ 222 X (2.2K)	B	64.6/78.2
R532	7030005000	S.RES ERJ2GEJ 471 X (470)	B	45.1/37.1
R533	7030005090	S.RES ERJ2GEJ 104 X (100K)	T	57.2/18.4
R534	7030005600	S.RES ERJ2GEJ 273 X (27K)	B	45.3/58.6
R535	7030004980	S.RES ERJ2GEJ 101 X (100)	B	55.8/55.3
R536	7030005600	S.RES ERJ2GEJ 273 X (27K)	B	55.8/58.6
R537	7030010040	S.RES ERJ2GEJ-JPW	B	41.6/41.2
R539	7030005100	S.RES ERJ2GEJ 154 X (150K)	T	64.2/71.2
R540	7030005090	S.RES ERJ2GEJ 104 X (100K)	T	90.6/17.9
R541	7030005220	S.RES ERJ2GEJ 223 X (22K)	T	28.9/55
R542	7030005110	S.RES ERJ2GEJ 224 X (220K)	B	39.9/72.7
R543	7030005080	S.RES ERJ2GEJ 823 X (82K)	B	40.8/71.1
C1	4030017420	S.CER ECJ0EC1H470J	B	120.7/39
C2	4030017420	S.CER ECJ0EC1H470J	B	22.9/78.1
C3	4030016930	S.CER ECJ0EB1A104K	B	130.8/50.2
C4	4030017420	S.CER ECJ0EC1H470J	B	122.2/37.1
C5	4030017420	S.CER ECJ0EC1H470J	B	21.7/77.1
C6	4030016930	S.CER ECJ0EB1A104K	B	52.4/77.9
C7	4030017420	S.CER ECJ0EC1H470J	B	123.1/37.1
C8	4030017420	S.CER ECJ0EC1H470J	B	21.7/75.5
C9	4030017460	S.CER ECJ0EB1E102K	T	17.6/59
C10	4030016930	S.CER ECJ0EB1A104K	B	55.7/77.9
C11	4030016930	S.CER ECJ0EB1A104K	B	124/37.1
C12	4030016930	S.CER ECJ0EB1A104K	B	22.1/74.3
C13	4030016930	S.CER ECJ0EB1A104K	B	55.6/80.7
C14	4030017460	S.CER ECJ0EB1E102K	T	16.1/59.9
C15	4030016930	S.CER ECJ0EB1A104K	T	62.4/67.5
C16	4030017420	S.CER ECJ0EC1H470J	T	56.2/64.5
C17	4030016930	S.CER ECJ0EB1A104K	B	115.6/40.6
C18	4030017700	S.CER ECJ0EC1H151J	T	62.4/71.2
C19	4030016930	S.CER ECJ0EB1A104K	B	22.9/80.3
C20	4550006250	S.TAN TEESVA 1A 106M8R	B	115.4/37.5
C21	4550006250	S.TAN TEESVA 1A 106M8R	B	21.3/80.5
C22	4030016930	S.CER ECJ0EB1A104K	B	50/77.9
C23	4030016930	S.CER ECJ0EB1A104K	T	57.8/52.6
C24	4030016930	S.CER ECJ0EB1A104K	B	50.3/81.1
C25	4030016930	S.CER ECJ0EB1A104K	B	54.4/81.1
C26	4030017460	S.CER ECJ0EB1E102K	B	117.8/39.2
C27	4030017460	S.CER ECJ0EB1E102K	B	23.8/80.3
C28	4030016930	S.CER ECJ0EB1A104K	B	53.3/77.9
C30	4030017460	S.CER ECJ0EB1E102K	B	59.8/67
C31	4030016930	S.CER ECJ0EB1A104K	T	60.5/53
C32	4030017590	S.CER ECJ0EC1H070C	B	38.4/79.1
C33	4030016930	S.CER ECJ0EB1A104K	T	58.9/67
C34	4030017570	S.CER ECJ0EC1H040B	B	37.2/78.7
C35	4030016930	S.CER ECJ0EB1A104K	B	38.3/76
C36	4030017500	S.CER ECJ0EC1H560J	B	37.2/79.6
C37	4030016930	S.CER ECJ0EB1A104K	B	48.4/79.8

[MAIN UNIT]

REF NO.	ORDER NO.	DESCRIPTION	M.	H/V LOCATION
C38	4030016930	S.CER ECJ0EB1A104K	B	69.8/78.2
C39	4030017360	S.CER ECJ0EC1H030B	B	71.4/77.3
C40	4030017760	S.CER ECJ0EB1H222K	B	68.2/77.3
C41	4030018860	S.CER ECJ0EB0J105K	B	31/58.2
C42	4030017760	S.CER ECJ0EB1H222K	B	68.2/76.4
C43	4030016930	S.CER ECJ0EB1A104K	B	55.6/49
C44	4030018860	S.CER ECJ0EB0J105K	B	35.7/56.4
C45	4030016950	S.CER ECJ0EB1A473K	B	34.5/55.2
C47	4030017460	S.CER ECJ0EB1E102K	B	64.6/77.3
C48	4030016930	S.CER ECJ0EB1A104K	T	52.7/54.4
C49	4030018860	S.CER ECJ0EB0J105K	B	15.6/58.3
C50	4030016930	S.CER ECJ0EB1A104K	B	130.8/48.4
C51	4030017620	S.CER ECJ0EC1H100C	B	125.1/45.3
C52	4030017420	S.CER ECJ0EC1H470J	B	120.6/48.8
C53	4030017420	S.CER ECJ0EC1H470J	B	32.7/78.4
C54	4030017660	S.CER ECJ0EC1H330J	B	32.7/77.3
C56	4030016950	S.CER ECJ0EB1A473K	B	31.9/59.1
C59	4030017430	S.CER ECJ0EC1H101J	B	32.7/76.4
C60	4030017620	S.CER ECJ0EC1H100C	B	32.3/72.9
C61	4030018900	S.CER ECJ0EB0J474K	B	18/63.8
C62	4030016930	S.CER ECJ0EB1A104K	B	33.6/55.2
C63	4030016930	S.CER ECJ0EB1A104K	T	55.5/61.6
C66	4030017430	S.CER ECJ0EC1H101J	B	123.5/48.4
C67	4030017460	S.CER ECJ0EB1E102K	B	67.5/87.7
C69	4030016930	S.CER ECJ0EB1A104K	B	29.8/63
C70	4030017460	S.CER ECJ0EB1E102K	B	64.3/79.4
C71	4030016930	S.CER ECJ0EB1A104K	B	57.6/43.3
C72	4030018910	S.CER C1608 JB 0J 475K-T	B	29.3/61.9
C73	4030017460	S.CER ECJ0EB1E102K	B	96.3/45.4
C75	4030017460	S.CER ECJ0EB1E102K	B	36/105.6
C77	4030016930	S.CER ECJ0EB1A104K	T	53.9/57.7
C78	4030017460	S.CER ECJ0EB1E102K	B	119.7/50.4
C79	4030017460	S.CER ECJ0EB1E102K	B	34.3/79.5
C80	4030017350	S.CER ECJ0EC1H020B	[USA-01] [EXP-01]	B 102.4/45.6
	4030017350	S.CER ECJ0EC1H020B	[USA-02]	
	4030017550	S.CER ECJ0EC1H1R5B	[USA-02]	
	4030017550	S.CER ECJ0EC1H1R5B	[EXP-02]	
	4030017350	S.CER ECJ0EC1H020B	[EUR-01]	
C81	4030017350	S.CER ECJ0EC1H020B	[USA-01] [EXP-01]	B 42.2/99.6
	4030017350	S.CER ECJ0EC1H020B	[USA-02]	
	4030017550	S.CER ECJ0EC1H1R5B	[EXP-02]	
	4030017350	S.CER ECJ0EC1H020B	[EUR-01]	
C82	4550006250	S.TAN TEESVA 1A 106M8R	B	61.1/79.2
C83	4030017460	S.CER ECJ0EB1E102K	B	71.7/86.7
C84	4030017420	S.CER ECJ0EC1H470J	B	74.7/81.1
C85	4030017590	S.CER ECJ0EC1H070C	B	56/43.3
C86	4030016930	S.CER ECJ0EB1A104K	B	51.7/47.1
C87	4030018910	S.CER C1608 JB 0J 475K-T	B	54.3/48.4
C88	4030017770	S.CER ECJ0EB1E332K	B	86.7/40.6
C89	4030017770	S.CER ECJ0EB1E332K	B	28/99.3
C90	4030017680	S.CER ECJ0EC1H820J	B	69.1/86.7
C91	4030016930	S.CER ECJ0EB1A104K	T	60.7/66.3
C92	4030016790	S.CER ECJ0EB1C103K	B	72.7/88
C93	4030017460	S.CER ECJ0EB1E102K	B	70/87.9
C96	4030018910	S.CER C1608 JB 0J 475K-T	B	49.2/48.9
C97	4030016930	S.CER ECJ0EB1A104K	B	57.4/50.6
C98	4030017460	S.CER ECJ0EB1E102K	B	35.1/107.3
C99	4030017460	S.CER ECJ0EB1E102K	B	40.8/72.7
C101	4030017620	S.CER ECJ0EC1H100C	B	37.7/63.2
C102	4550000560	S.TAN TEESVA 1V 334M8R	B	84.7/42.7
C103	4550003260	S.TAN TEESVA 1V 684M8R	B	26.2/100.4
C104	4030016930	S.CER ECJ0EB1A104K	B	39.9/74.5
C105	4030017520	S.CER ECJ0EC1H0R3B	B	103.2/47.8
C106	4030017340	S.CER ECJ0EC1H010B	B	47/100.1
C107	4030017590	S.CER ECJ0EC1H070C	B	72.3/89.5
C108	4030017460	S.CER ECJ0EB1E102K	B	94.5/47.1
C109	4030017530	S.CER ECJ0EC1HOR5B	B	101.9/48.3
C110	4030017530	S.CER ECJ0EC1HOR5B	B	46.5/101.4
C111	4030016790	S.CER ECJ0EB1C103K	B	70.7/92.3
C112	4550000270	S.TAN TEESVA 1E 474M8R	B	84.7/47.9
C113	4550000270	S.TAN TEESVA 1E 474M8R	B	26.2/105.6
C114	4030017520	S.CER ECJ0EC1HOR3B	B	103.2/49.6
C115	4030017550	S.CER ECJ0EC1H1R5B	[USA-01] [EXP-01]	B 47/102.8
	4030017550	S.CER ECJ0EC1H1R5B	[USA-02]	
	4030017340	S.CER ECJ0EC1H010B	[EXP-02]	
	4030017340	S.CER ECJ0EC1H010B	[EUR-01]	
C116	4030017460	S.CER ECJ0EB1E102K	B	70.7/89.5
C117	4030016790	S.CER ECJ0EB1C103K	B	69.1/90.4
C118	4030016790	S.CER ECJ0EB1C103K	B	69.1/91.3
C121	4030016790	S.CER ECJ0EB1C103K	B	71.1/94.8
C122	4030016790	S.CER ECJ0EB1C103K	B	67.2/91.6
C123	4030016930	S.CER ECJ0EB1A104K	B	67.5/100.1
C124	4030016930	S.CER ECJ0EB1A104K	B	48.5/50.5
C125	4030016790	S.CER ECJ0EB1C103K	B	95.4/43.7
C126	4030016790	S.CER ECJ0EB1C103K	B	57.2/35.1
C127	4030016790	S.CER ECJ0EB1C103K	B	36/103.9
C133	4030017590	S.CER ECJ0EC1H070C		

## [MAIN UNIT]

REF NO.	ORDER NO.	DESCRIPTION	M.	H/V LOCATION
C152	4030016930	S.CER ECJ0EB1A104K	B	55.3/32.4
C153	4030017380	S.CER ECJ0EC1H050B	B	49.8/34.9
C154	4030017420	S.CER ECJ0EC1H470J	B	26.5/120.6
C155	4030017460	S.CER ECJ0EB1E102K	B	26.5/123.2
C156	4030017420	S.CER ECJ0EC1H470J	B	28.5/111.5
C157	4030017460	S.CER ECJ0EB1E102K	B	28/117.2
C158	4030017420	S.CER ECJ0EC1H470J	B	81.7/62.1
C159	4030017420	S.CER ECJ0EB1A104K	B	81.7/53.6
C160	4030016790	S.CER ECJ0EB1C103K	B	65.7/104.4
C161	4030016790	S.CER ECJ0EB1C103K	B	62.7/98.9
C162	4030016930	S.CER ECJ0EB1A104K	B	81.7/67.1
C163	4030016930	S.CER ECJ0EB1A104K	B	81.7/58.6
C164	4030016930	S.CER ECJ0EB1A104K	B	49.5/36.8
C165	4030017460	S.CER ECJ0EB1E102K	B	81.7/66.2
C166	4030017460	S.CER ECJ0EB1E102K	B	81.7/57.7
C167	4030017460	S.CER ECJ0EB1E102K	B	97.3/45.4
C168	4030017380	S.CER ECJ0EC1H050B	B	32.6/124.3
C169	4030017620	S.CER ECJ0EC1H100C [USA-01]	B	30.8/124.4
	4030017620	S.CER ECJ0EC1H100C [EXP-01]		
	4030017570	S.CER ECJ0EC1H040B [USA-02]		
	4030017570	S.CER ECJ0EC1H040B [EXP-02]		
	4030017620	S.CER ECJ0EC1H100C [EUR-01]		
C170	4030017580	S.CER ECJ0EC1H060C	B	30.6/114.4
C171	4030017630	S.CER ECJ0EC1H120J [USA-01]	B	30.6/115.3
	4030017630	S.CER ECJ0EC1H120J [EXP-01]		
	4030017380	S.CER ECJ0EC1H050B [USA-02]		
	4030017380	S.CER ECJ0EC1H050B [EXP-02]		
	4030017630	S.CER ECJ0EC1H120J [EUR-01]		
C172	4030017580	S.CER ECJ0EC1H060C [USA-01]	B	87.8/65.7
	4030017580	S.CER ECJ0EC1H060C [EXP-01]		
	4030017570	S.CER ECJ0EC1H040B [USA-02]		
	4030017570	S.CER ECJ0EC1H040B [EXP-02]		
	4030017580	S.CER ECJ0EC1H060C [EUR-01]		
C173	4030017630	S.CER ECJ0EC1H120J [USA-01]	B	86.5/65.3
	4030017620	S.CER ECJ0EC1H100C [USA-02]		
	4030017620	S.CER ECJ0EC1H100C [EXP-02]		
	4030017630	S.CER ECJ0EC1H120J [EUR-01]		
C174	4030017590	S.CER ECJ0EC1H070C [USA-01]	B	85.7/55
	4030017590	S.CER ECJ0EC1H070C [EXP-01]		
	4030017580	S.CER ECJ0EC1H060C [USA-02]		
	4030017580	S.CER ECJ0EC1H060C [EXP-02]		
	4030017590	S.CER ECJ0EC1H070C [EUR-01]		
C175	4030017390	S.CER ECJ0EC1H180J [USA-01]	B	85.7/55.9
	4030017390	S.CER ECJ0EC1H180J [EXP-01]		
	4030017590	S.CER ECJ0EC1H070C [USA-02]		
	4030017590	S.CER ECJ0EC1H070C [EXP-02]		
	4030017390	S.CER ECJ0EC1H180J [EUR-01]		
C176	4030018860	S.CER ECJ0EB0J105K	T	62.9/51
C177	4030017380	S.CER ECJ0EC1H050B [USA-01]	B	35.6/120.7
	4030017380	S.CER ECJ0EC1H050B [EXP-01]		
	4030017350	S.CER ECJ0EC1H020B [USA-02]		
	4030017350	S.CER ECJ0EC1H020B [EXP-02]		
	4030017380	S.CER ECJ0EC1H050B [EUR-01]		
C178	4030017580	S.CER ECJ0EC1H060C [USA-01]	B	32/112.2
	4030017580	S.CER ECJ0EC1H060C [EXP-01]		
	4030017360	S.CER ECJ0EC1H030B [USA-02]		
	4030017360	S.CER ECJ0EC1H030B [EXP-02]		
	4030017580	S.CER ECJ0EC1H060C [EUR-01]		
C179	4030017420	S.CER ECJ0EC1H470J	T	14.9/129.1
C180	4030017600	S.CER ECJ0EC1H080C [USA-01]	B	91.5/62
	4030017600	S.CER ECJ0EC1H080C [EXP-01]		
	4030017570	S.CER ECJ0EC1H040B [USA-02]		
	4030017570	S.CER ECJ0EC1H040B [EXP-02]		
	4030017600	S.CER ECJ0EC1H080C [EUR-01]		
C181	4030017590	S.CER ECJ0EC1H070C [USA-01]	B	87.1/52.9
	4030017590	S.CER ECJ0EC1H070C [EXP-01]		
	4030017380	S.CER ECJ0EC1H050B [USA-02]		
	4030017380	S.CER ECJ0EC1H050B [EXP-02]		
	4030017590	S.CER ECJ0EC1H070C [EUR-01]		
C182	4030016790	S.CER ECJ0EB1C103K	B	63.1/104.4
C183	4030017420	S.CER ECJ0EC1H470J	T	14.9/131.3
C184	4030017620	S.CER ECJ0EC1H100C	B	34.9/124.3
C185	4030017630	S.CER ECJ0EC1H120J [USA-01]	B	35.4/115.3
	4030017630	S.CER ECJ0EC1H120J [EXP-01]		
	4030017610	S.CER ECJ0EC1H090C [USA-02]		
	4030017610	S.CER ECJ0EC1H090C [EXP-02]		
	4030017630	S.CER ECJ0EC1H120J [EUR-01]		
C186	4030017420	S.CER ECJ0EC1H470J	B	98.2/48.8
C187	4030017540	S.CER ECJ0EC1HR75B [USA-01]	B	89.4/66.8
	4030017540	S.CER ECJ0EC1HR75B [EXP-01]		
	4030017530	S.CER ECJ0EC1HOR5B [USA-02]		
	4030017530	S.CER ECJ0EC1HOR5B [EXP-02]		
	4030017540	S.CER ECJ0EC1HR75B [EUR-01]		
C188	4030017360	S.CER ECJ0EC1H030B	B	90.6/66.6
C189	4030017340	S.CER ECJ0EC1H010B	B	87/57.2
C190	4030017350	S.CER ECJ0EC1H020B [USA-01]	B	87/58.2
	4030017350	S.CER ECJ0EC1H020B [EXP-01]		
	4030017340	S.CER ECJ0EC1H010B [USA-02]		
	4030017340	S.CER ECJ0EC1H010B [EXP-02]		
	4030017350	S.CER ECJ0EC1H020B [EUR-01]		
C191	4030017380	S.CER ECJ0EC1H050B [USA-01]	B	89.4/65.7
	4030017380	S.CER ECJ0EC1H050B [EXP-01]		
	4030017640	S.CER ECJ0EC1H150J [USA-02]		
	4030017640	S.CER ECJ0EC1H150J [EXP-02]		
	4030017380	S.CER ECJ0EC1H050B [EUR-01]		
C192	4030017640	S.CER ECJ0EC1H150J [USA-01]	B	90.5/56.3
	4030017640	S.CER ECJ0EC1H150J [EXP-01]		
	4030017600	S.CER ECJ0EC1H080C [USA-02]		
	4030017600	S.CER ECJ0EC1H080C [EXP-02]		
	4030017640	S.CER ECJ0EC1H150J [EUR-01]		
C193	4030017460	S.CER ECJ0EB1E102K	B	61.4/107.1
C194	4030017580	S.CER ECJ0EC1H060C [USA-01]	B	36.8/122.8
	4030017580	S.CER ECJ0EC1H060C [EXP-01]		

## [MAIN UNIT]

REF NO.	ORDER NO.	DESCRIPTION	M.	H/V LOCATION
C194	4030017600	S.CER ECJ0EC1H080C [USA-02]	B	36.8/122.8
	4030017600	S.CER ECJ0EC1H080C [EXP-02]		
	4030017580	S.CER ECJ0EC1H060C [EUR-01]		
C195	4030017630	S.CER ECJ0EC1H120J	B	40.1/120.7
C196	4030017620	S.CER ECJ0EC1H100C	B	37.6/114.4
C197	4030017640	S.CER ECJ0EC1H150J	B	41/112.2
C198	4030016790	S.CER ECJ0EB1C103K	B	60.5/107.1
C200	4030017570	S.CER ECJ0EC1H040B	B	92.4/64.3
C201	4030017620	S.CER ECJ0EC1H100C	B	96/62
C202	4030017610	S.CER ECJ0EC1H090C	B	93.1/55.4
C203	4030017390	S.CER ECJ0EC1H180J	B	96.3/52.9
C204	4550006250	S.TAN TEESVA 1A 106M8R	T	81.7/17
C205	4550006250	S.TAN TEESVA 1A 106M8R	T	85.1/17
C206	4550006250	S.TAN TEESVA 1A 106M8R	T	88.8/16.7
C208	4030017490	S.CER C1608 JB 1A 105K-T	T	80/16.6
C209	4030017490	S.CER C1608 JB 1A 105K-T	T	83.4/16.6
C210	4030017490	S.CER C1608 JB 1A 105K-T	T	86.9/16.3
C211	4030016930	S.CER ECJ0EB1A104K	B	38.3/120.7
C212	4030016790	S.CER ECJ0EB1C103K	B	39.2/112.2
C213	4030017660	S.CER ECJ0EC1H330J	B	68.5/106.1
C214	4030017460	S.CER ECJ0EB1E102K	B	66.8/107
C215	4030017530	S.CER ECJ0EC1HOR5B	B	41.9/120.7
C216	4030017520	S.CER ECJ0EC1HOR3B	B	42.6/115.7
C217	4030017460	S.CER ECJ0EB1E102K	B	39.2/120.7
C218	4030017460	S.CER ECJ0EB1E102K	B	40.1/112.2
C219	4030016790	S.CER ECJ0EB1C103K	B	94.2/62
C220	4030017530	S.CER ECJ0EC1HOR5B	B	98.2/61.3
C221	4030016790	S.CER ECJ0EB1C103K	B	94.5/52.9
C222	4030017530	S.CER ECJ0EC1HOR5B	B	98.2/57.1
C224	4030017460	S.CER ECJ0EB1E102K	B	95.1/62
C225	4030017460	S.CER ECJ0EB1E102K	B	95.4/52.9
C228	4030017490	S.CER C1608 JB 1A 105K-T	T	79.8/24.4
C229	4030017490	S.CER C1608 JB 1A 105K-T	T	83.3/24.4
C230	4030017490	S.CER C1608 JB 1A 105K-T	T	86.8/24.4
C231	4550005980	S.TAN TEESVA 1A 475M8R	T	81.6/25.6
C232	4550005980	S.TAN TEESVA 1A 475M8R	T	85.1/25.6
C233	4550005980	S.TAN TEESVA 1A 475M8R	T	88.5/25.6
C235	4030017030	S.CER ECJ0EB1A273K	T	41/55
C236	4030017730	S.CER ECJ0EB1E471K	B	100.5/55
C237	4030017460	S.CER ECJ0EB1E102K	B	100.5/60.4
C238	4030017730	S.CER ECJ0EB1E471K	B	44.9/112.6
C239	4030017460	S.CER ECJ0EB1E102K	B	44.9/118
C240	4510008540	S.ELE EEE1CA100SR	T	95.1/22.3
C241	4030017350	S.CER ECJ0EB1E020B	B	68.3/120.9
C242	4030016790	S.CER ECJ0EB1C103K	B	68.7/111.2
C243	4030017460	S.CER ECJ0EB1E102K	B	70.3/106.1
C244	4030016790	S.CER ECJ0EB1C103K	B	70.3/107
C245	4030017460	S.CER ECJ0EB1E102K	B	91.5/59.6
C246	4030017580	S.CER ECJ0EC1H060C	B	46.9/113.5
C247	4030017460	S.CER ECJ0EB1E102K	B	43.1/109.1
C248	4030017460	S.CER ECJ0EB1E102K	B	36/117.8
C249	4030017420	S.CER ECJ0EC1H470J	B	48.1/109.1
C250	4030017380	S.CER ECJ0EC1H050B	B	103.7/58.7
C251	4030017580	S.CER ECJ0EC1H060C [USA-01]	B	102.6/55.9
	4030017580	S.CER ECJ0EC1H060C [EXP-01]		
	4030017600	S.CER ECJ0EC1H080C [USA-02]		
	4030017600	S.CER ECJ0EC1H080C [EXP-02]		
	4030017580	S.CER ECJ0EC1H060C [EUR-01]		
C252	4030017460	S.CER ECJ0EB1E102K	B	100.5/50
C253	4030017380	S.CER ECJ0EC1H050B	B	48/116.2
C254	4030017460	S.CER ECJ0EB1E102K	B	103.7/53.4
C255	4030016930	S.CER ECJ0EB1A104K	T	42.1/50.6
C256	4030017640	S.CER ECJ0EC1H150J	T	43.1/55
C257	4030016790	S.CER ECJ0EB1C103K	T	34.5/58.8
C258	4030017580	S.CER ECJ0EC1H060C [USA-01]	B	59.6/117.8
	4030017580	S.CER ECJ0EC1H060C [EXP-01]		
	4030017620	S.CER ECJ0EC1H100C [USA-02]		
	4030017620	S.CER ECJ0EC1H100C [EXP-02]		
	4030017580	S.CER ECJ0EC1H060C [EUR-01]		
C259	4030017580	S.CER ECJ0EC1H060C	T	48.5/46.4
C260	4030017460	S.CER ECJ0EB1E102K	B	46.5/105.4
C262	4030016930	S.CER ECJ0EB1A104K	T	69.2/57.5
C263	4030017420	S.CER ECJ0EC1H470J	B	60.5/126.1
C264	4030017460	S.CER ECJ0EB1E102K	B	101.9/50
C265	4030017460	S.CER ECJ0EB1E102K	B	43.5/120.7
C266	4030018900	S.CER ECJ0EB0J474K	T	43.9/45.6
C267	4030017630	S.CER ECJ0EC1H120J [USA-01]	B	59.6/119.3
	4030017630	S.CER ECJ0EC1H120J [EXP-01]		
	4030017390	S.CER ECJ0EC1H180J [USA-02]		
	4030017390	S.CER ECJ0EC1H180J [EXP-02]		
	4030017630	S.CER ECJ0EC1H120J [EUR-01]		
C268	4030017420	S.CER ECJ0EC1H470J	B	62.3/126.1
C269	4550006780	S.TAN TEESVB2 0J 476M8R	T	71.8/60.8
C270	4030016930	S.CER ECJ0EB1A104K	T	40.5/49.7
C271	4030017350	S.CER ECJ0EC1H020B	B	68.1/137.9
C272	4030017630	S.CER ECJ0EC1H120J	T	47.3/60.1
C274	4030017460	S.CER ECJ0EB1E102K	B	44.4/120.7
C275	4030017620	S.CER ECJ0EC1H100C [USA-01]	B	48/124.4
	4030017620	S.CER ECJ0EC1H100C [EXP-01]		
	4030017580	S.CER ECJ0EC1H060C [USA-02]		
	4030017580	S.CER ECJ0EC1H060C [EXP-02]		
	4030017620	S.CER ECJ0EC1H100C [EUR-01]		
C276	4030017530	S.CER ECJ0EC1HOR5B [USA-01]	B	67.2/137.9
	4030017530	S.CER ECJ0EC1HOR5B [EXP-01]		
	4030017530	S.CER ECJ0EC1HOR5B [EUR-01]		
C277	4030016790	S.CER ECJ0EB1C103K	T	48.6/36.7
C279	4030			

[MAIN UNIT]

REF NO.	ORDER NO.	DESCRIPTION	M.	H/V LOCATION
C282	4030017620	S.CER ECJ0EC1H100C [EXP-01]	B	61.4/122.2
	4030017580	S.CER ECJ0EC1H060C [USA-02]		
	4030017580	S.CER ECJ0EC1H060C [EXP-02]		
	4030017620	S.CER ECJ0EC1H100C [EUR-01]		
C283	4030017620	S.CER ECJ0EC1H100C	B	103.7/65.9
C285	4030017620	S.CER ECJ0EC1H100C [USA-01]	B	66.1/137.9
	4030017620	S.CER ECJ0EC1H100C [EXP-01]		
	4030017580	S.CER ECJ0EC1H060C [USA-02]		
	4030017580	S.CER ECJ0EC1H060C [EXP-02]		
	4030017620	S.CER ECJ0EC1H100C [EUR-01]		
C286	4030017530	S.CER ECJ0EC1H0R5B	B	64.5/139.2
C287	4030017350	S.CER ECJ0EC1H020B [USA-01]	B	61.8/134.7
	4030017350	S.CER ECJ0EC1H020B [EXP-01]		
	4030017550	S.CER ECJ0EC1H1R5B [USA-02]		
	4030017550	S.CER ECJ0EC1H1R5B [EXP-02]		
	4030017350	S.CER ECJ0EC1H020B [EUR-01]		
C291	4030017340	S.CER ECJ0EC1H010B [USA-01]	B	102.4/66.6
	4030017340	S.CER ECJ0EC1H010B [EXP-01]		
	4030017340	S.CER ECJ0EC1H010B [EUR-01]		
C292	4030017460	S.CER ECJ0EB1E102K	B	65/136.3
C293	4030017620	S.CER ECJ0EC1H100C [USA-01]	B	62.9/137.9
	4030017620	S.CER ECJ0EC1H100C [EXP-01]		
	4030017580	S.CER ECJ0EC1H060C [USA-02]		
	4030017580	S.CER ECJ0EC1H060C [EXP-02]		
	4030017620	S.CER ECJ0EC1H100C [EUR-01]		
C294	4030017530	S.CER ECJ0EC1H0R5B	B	58.3/138.5
C295	4030017460	S.CER ECJ0EB1E102K	B	65/134.7
C296	4030017620	S.CER ECJ0EC1H100C [USA-01]	B	56.1/138
	4030017620	S.CER ECJ0EC1H100C [EXP-01]		
	4030017580	S.CER ECJ0EC1H060C [USA-02]		
	4030017580	S.CER ECJ0EC1H060C [EXP-02]		
	4030017620	S.CER ECJ0EC1H100C [EUR-01]		
C298	4030017460	S.CER ECJ0EB1E102K	B	136.2/82.9
C299	4030017460	S.CER ECJ0EB1E102K	B	50.4/133.8
C300	4030017460	S.CER ECJ0EB1E102K	B	54.1/133.9
C301	4030016790	S.CER ECJ0EB1C103K	B	51.4/133.8
C302	4030017460	S.CER ECJ0EB1E102K	B	52/138.5
C303	4030017370	S.CER ECJ0EC1H3R5B	B	131.4/82.3
C304	4030017420	S.CER ECJ0EC1H470J	B	136.2/81.9
C305	4030017420	S.CER ECJ0EC1H470J	B	46.4/133.8
C306	4030017460	S.CER ECJ0EB1E102K	B	47.4/133.8
C307	4030017460	S.CER ECJ0EB1E102K	B	45.4/138.3
C309	4030017420	S.CER ECJ0EC1H470J	B	136.8/84.5
C310	4030017380	S.CER ECJ0EC1H050B [USA-01]	B	134.9/85.9
	4030017380	S.CER ECJ0EC1H050B [EXP-01]		
	4030017370	S.CER ECJ0EC1H3R5B [USA-02]		
	4030017370	S.CER ECJ0EC1H3R5B [EXP-02]		
	4030017380	S.CER ECJ0EC1H050B [EUR-01]		
C311	4030016930	S.CER ECJ0EB1A104K	B	45.4/140.4
C312	4030017420	S.CER ECJ0EC1H470J	B	50.4/140.4
C313	4030016930	S.CER ECJ0EB1A104K	B	46.4/140.4
C314	4030017460	S.CER ECJ0EB1E102K	B	49.4/140.4
C315	4030017730	S.CER ECJ0EB1E471K	B	137.8/84.5
C316	4030017570	S.CER ECJ0EC1H040B	B	130.4/80.9
C321	4030017420	S.CER ECJ0EC1H470J	T	66/57.5
C322	4030017420	S.CER ECJ0EC1H470J	T	67.6/54.3
C323	4030017620	S.CER ECJ0EC1H100C	B	44.4/137.7
C324	4030017530	S.CER ECJ0EC1H0R5B [USA-01]	B	134.9/88.3
	4030017530	S.CER ECJ0EC1H0R5B [EXP-01]		
	4030017520	S.CER ECJ0EC1H0R3B [USA-02]		
	4030017520	S.CER ECJ0EC1H0R3B [EXP-02]		
	4030017530	S.CER ECJ0EC1H0R5B [EUR-01]		
C326	4030017580	S.CER ECJ0EC1H060C [USA-01]	B	39.3/138.2
	4030017580	S.CER ECJ0EC1H060C [EXP-01]		
	4030017590	S.CER ECJ0EC1H070C [USA-02]		
	4030017590	S.CER ECJ0EC1H070C [EXP-02]		
	4030017580	S.CER ECJ0EC1H060C [EUR-01]		
C327	4030017360	S.CER ECJ0EC1H030B [USA-01]	B	141.8/89.2
	4030017360	S.CER ECJ0EC1H030B [EXP-01]		
	4030017360	S.CER ECJ0EC1H030B [USA-02]		
	4030017360	S.CER ECJ0EC1H030B [EXP-02]		
	4030017350	S.CER ECJ0EC1H020B [EUR-01]		
C328	4030017420	S.CER ECJ0EC1H470J	B	140.9/85.4
C329	4030017410	S.CER ECJ0EC1H240J [USA-01]	B	38.4/133.5
	4030017410	S.CER ECJ0EC1H240J [EXP-01]		
	4030017390	S.CER ECJ0EC1H180J [USA-02]		
	4030017390	S.CER ECJ0EC1H180J [EXP-02]		
	4030017410	S.CER ECJ0EC1H240J [EUR-01]		
C330	4030017460	S.CER ECJ0EB1E102K	B	139.9/85.4
C331	4030017460	S.CER ECJ0EB1E102K	B	59.2/140.4
C332	4030018860	S.CER ECJ0EB0J105K	B	55/140.4
C333	4030016930	S.CER ECJ0EB1A104K	T	23.1/29.4
C335	4030017550	S.CER ECJ0EC1H1R5B	B	144/89.5
C336	4030018860	S.CER ECJ0EB0J105K	B	60.1/140.4
C337	4030017580	S.CER ECJ0EC1H060C	B	142.6/91.7
C338	4030017550	S.CER ECJ0EC1H1R5B	B	39.3/139.1
C339	4030017460	S.CER ECJ0EB1E102K	B	32.5/134
C340	4030016930	S.CER ECJ0EB1A104K	T	54/20.3
C341	4030017420	S.CER ECJ0EC1H470J	T	143.1/123.3
C342	4030017730	S.CER ECJ0EB1E471K	T	138.8/108
C345	4030017460	S.CER ECJ0EB1E102K	B	30.6/135.9
C346	4030017420	S.CER ECJ0EC1H470J	T	63.1/57.2
C347	4030017460	S.CER ECJ0EB1E102K	T	143.1/124.2
C348	4030017420	S.CER ECJ0EC1H470J	T	63.8/55.2
C349	4030017580	S.CER ECJ0EC1H060C	B	143.5/95.2
C350	4030017420	S.CER ECJ0EC1H470J	T	138.7/112.3
C351	4030017460	S.CER ECJ0EB1E102K	T	138.7/113.2
C352	4030017410	S.CER ECJ0EC1H240J [USA-01]	B	31.6/137.9
	4030017410	S.CER ECJ0EC1H240J [EXP-01]		
	4030017390	S.CER ECJ0EC1H180J [USA-02]		
	4030017390	S.CER ECJ0EC1H180J [EXP-02]		
	4030017410	S.CER ECJ0EC1H240J [EUR-01]		
C353	4030017460	S.CER ECJ0EB1E102K	T	140.4/118.8
C354	4030017420	S.CER ECJ0EC1H470J	T	106.6/115.9

[MAIN UNIT]

REF NO.	ORDER NO.	DESCRIPTION	M.	H/V LOCATION
C355	4030017580	S.CER ECJ0EC1H060C [USA-01]	B	37.5/136.8
	4030017580	S.CER ECJ0EC1H060C [EXP-01]		
	4030017590	S.CER ECJ0EC1H070C [USA-02]		
	4030017590	S.CER ECJ0EC1H070C [EXP-02]		
	4030017580	S.CER ECJ0EC1H060C [EUR-01]		
C357	4030017630	S.CER ECJ0EC1H120J	B	39.3/140
C358	4030016790	S.CER ECJ0EB1C103K	T	137.5/128.2
C359	4510009550	S.ELE EEEFK1C100R	T	107.2/86.5
C360	4030017460	S.CER ECJ0EB1E102K	T	106.6/116.8
C361	4030011030	S.CER GRM31M4C2H1R5CY21L (GRM42-6 CK) [EUR-01] only	B	100.2/115.8
C362	4030017510	S.CER ECJ0EC1H680J	B	39.7/144.6
C364	40300011020	S.CER GRM31M4C2H1R0CY21L (GRM42-6 CK)	B	89.8/119.8
C365	4030017730	S.CER ECJ0EB1E471K	T	106.6/117.7
C366	4030016970	S.CER ECJ0EB1C223K	T	142.4/126.6
C367	4510009810	S.ELE EEEFK1E220R	T	107.3/95.1
C368	4030006860	S.CER C1608 JB 1H 102K-T	T	89.1/142
C369	4030017460	S.CER ECJ0EB1E102K	B	33.4/134
C370	40300011060	S.CER GRM31M2C2H4R0CY21L (GRM42-6 CH)[USA-01]	B	100.2/123.1
	4030011060	S.CER GRM31M2C2H4R0CY21L (GRM42-6 CH) [EXP-01]		
	4030011070	S.CER GRM31M2C2H5R0CY21L (GRM42-6 CH) [EUR-01]		
C371	4030006980	S.CER C1608 CH 1H 070D-T	T	35.5/142.5
C372	40300011100	S.CER GRM31M2C2H8R0DV01L (GRM42-6 CH)	B	100.2/121
C373	4030017780	S.CER ECJ0EB1E472K	T	136.7/123.8
C374	4030017420	S.CER ECJ0EC1H470J	B	85.2/129.8
C375	4030017460	S.CER ECJ0EB1E102K	T	113.1/95.2
C376	4030017350	S.CER ECJ0EC1H020B	B	86/138.8
C377	4030017420	S.CER ECJ0EC1H470J	B	84.2/119.4
C378	4030017420	S.CER ECJ0EC1H470J	T	112.2/95.2
C381	4030017400	S.CER ECJ0EC1H220J	T	111.3/95.2
C383	4030017460	S.CER ECJ0EB1E102K	T	114/78.2
C385	4030017460	S.CER ECJ0EB1E102K	B	22.8/142.4
C386	4030017460	S.CER ECJ0EB1E102K	T	139.2/119.6
C387	4030017600	S.CER ECJ0EC1H080C	B	89.7/137.9
C388	4510009550	S.ELE EEEFK1C100R	T	126.4/77.2
C389	4030017200	S.CER GRM31BR32J102KY01L (GHM1030 F)	B	96.8/130.4
C390	40300011070	S.CER GRM31M2C2H5R0CY21L (GRM42-6 CH)	B	87.6/133.2
C391	4030017460	S.CER ECJ0EB1E102K	T	122.2/76
C392	4030017520	S.CER ECJ0EC1H0R3B	B	95.4/134.3
C393	40300011050	S.CER GRM31M3C2H3R0CY21L (GRM42-6 CJ)	B	98.4/126.8
C394	4550006250	S.TAN TEESVA 1A 106M8R	B	26.3/15.3
C395	40300011050	S.CER GRM31M3C2H3R0CY21L (GRM42-6 CJ)	B	100.5/126.9
C396	4510009550	S.ELE EEEFK1C100R	T	97/77.8
C397	4030017460	S.CER ECJ0EB1E102K	T	137.4/118.5
C398	4550006250	S.TAN TEESVA 1A 106M8R	B	31.7/15.5
C399	4030017460	S.CER ECJ0EB1E102K	T	100/76.1
C400	4030017460	S.CER ECJ0EB1E102K	B	86.2/129.8
C401	40300011080	S.CER GRM31M2C2H6R0DV01L (GRM42-6 CH)	B	103.2/130.9
C402	4030016930	S.CER ECJ0EB1A104K	T	47.2/71.6
C403	40300011050	S.CER GRM31M3C2H3R0CY21L (GRM42-6 CJ)	B	106.2/130.9
C404	4030017460	S.CER ECJ0EB1E102K	T	140.7/129.2
C405	4030017420	S.CER ECJ0EC1H470J	B	56.7/55.3
C406	4030016790	S.CER ECJ0EB1C103K	T	103.5/76.2
C407	4030011030	S.CER GRM31M4C2H1R5CY21L (GRM42-6 CK)	B	102.6/137.2
C408	4030017460	S.CER ECJ0EB1E102K	B	98.1/138.5
C409	40300011050	S.CER GRM31M3C2H3R0CY21L (GRM42-6 CJ)	B	110.9/136
C410	40300011050	S.CER GRM31M3C2H3R0CY21L (GRM42-6 CJ) [USA-01]	B	113/134
	4030011050	S.CER GRM31M3C2H3R0CY21L (GRM42-6 CJ) [EXP-01]		
	4030011060	S.CER GRM31M2C2H4R0CY21L (GRM42-6 CH) [USA-02]		
	4030011060	S.CER GRM31M2C2H4R0CY21L (GRM42-6 CH) [EXP-02]		
	4030011050	S.CER GRM31M3C2H3R0CY21L (GRM42-6 CJ) [EUR-01]		
C411	4550007650	S.TAN F931V105MAABMA	T	37.5/68.6
C412	4030017460	S.CER ECJ0EB1E102K	T	112.6/78.5
C413	4030016930	S.CER ECJ0EB1A104K	T	38.5/71.9
C414	4030017420	S.CER ECJ0EC1H470J	B	29.7/135.9
C415	4550007650	S.TAN F931V105MAABMA	T	37.5/63.4
C416	4550006250	S.TAN TEESVA 1A 106M8R	T	107.8/81.5
C417	4030016930	S.CER ECJ0EB1A104K	T	15/125.7
C418	4550007650			



[MAIN UNIT]

REF NO.	ORDER NO.	DESCRIPTION	M.	H/V LOCATION
C426	4030009530	S.CER C1608 CH 1H 030B-T [EXP-02]	B	120.8/139.5
	4030009540	S.CER C1608 CH 1H 1R5B-T [EUR-01]		
C431	4030018860	S.CER ECJ0EB0J105K	B	33.3/13.6
C432	4030016930	S.CER ECJ0EB1A104K	T	10.8/120.6
C433	4030006860	S.CER C1608 JB 1H 102K-T	B	139.5/137.7
C434	4030017460	S.CER ECJ0EB1E102K	B	140.5/131
C435	4030017460	S.CER ECJ0EB1E102K	T	54.8/29.8
C436	4030011050	S.CER GRM31M3C2H3R0CY21L [USA-01]	B	144.8/138.6
	4030011050	S.CER GRM31M3C2H3R0CY21L [EXP-01]		
	4030011050	S.CER GRM31M3C2H3R0CY21L [USA-02]		
	4030011050	S.CER GRM31M3C2H3R0CY21L [EXP-02]		
	4030011040	S.CER GRM31M4C2H2R0CY21L [EUR-01]		
C437	4030016930	S.CER ECJ0EB1A104K	B	34.4/12
C438	4030016790	S.CER ECJ0EB1C103K	T	112.8/88.2
C439	4510009810	S.ELE EEEFK1E220R	B	128.4/89.8
C440	4030018900	S.CER ECJ0EB0J474K	T	7.9/129.6
C441	4030017440	S.CER ECJ0EC1H221J	T	12/126.2
C442	4510008780	S.ELE EEE1EA471P	B	9.6/119.8
C443	4030017460	S.CER ECJ0EB1E102K	T	111.9/88.2
C444	4030011070	S.CER GRM31M2C2H5R0CY21L [USA-01]	B	147.1/148.9
	4030011070	S.CER GRM31M2C2H5R0CY21L [EXP-01]		
	4030011070	S.CER GRM31M2C2H5R0CY21L [USA-02]		
	4030011070	S.CER GRM31M2C2H5R0CY21L [EXP-02]		
	4030011060	S.CER GRM31M2C2H4R0CY21L [EUR-01]		
C446	4030017460	S.CER ECJ0EB1E102K	T	6.6/130.1
C448	4030017460	S.CER ECJ0EB1E102K	T	128.8/102.4
C449	4510008870	S.ELE EEE1AA471UP	B	8.9/139.2
C450	4030016930	S.CER ECJ0EB1A104K	T	7/125.3
C451	4030018860	S.CER ECJ0EB0J105K	T	8.6/125.3
C452	4030018860	S.CER ECJ0EB0J105K	T	72/98.2
C453	4030017460	S.CER ECJ0EB1E102K	T	130.8/103.6
C454	4030017430	S.CER ECJ0EC1H101J	B	46.3/56.9
C458	4030017460	S.CER ECJ0EB1E102K	T	114.8/95.7
C459	4030017460	S.CER ECJ0EB1E102K	T	116.3/119.1
C460	4030017460	S.CER ECJ0EB1E102K	B	9.6/147.3
C461	4030017420	S.CER ECJ0EC1H470J	T	114.8/94.8
C462	4030017420	S.CER ECJ0EC1H470J	T	115.3/119.1
C463	4030017420	S.CER ECJ0EC1H470J	B	9.6/146.4
C464	4510009680	S.ELE EEEFK1E421P	B	144.4/121.1
C465	4550006250	S.TAN TEESVA 1A 106M8R	T	102.7/92
C466	4030017420	S.CER ECJ0EC1H470J	T	99.9/88
C467	4030016930	S.CER ECJ0EB1A104K	T	62.3/58.5
C468	4030016930	S.CER ECJ0EB1A104K	T	61.7/56.9
C470	4030018860	S.CER ECJ0EB0J105K	T	7.4/122.3
C471	4030016790	S.CER ECJ0EB1C103K	T	7/124.4
C472	4030018860	S.CER ECJ0EB0J105K	T	10.9/117.7
C473	4030018860	S.CER ECJ0EB0J105K	T	5/118.9
C474	4030017780	S.CER ECJ0EB1E472K	T	115.3/17.6
C475	4510008120	S.ELE 16 CE 100 BS	T	125.1/12.1
C476	4510008120	S.ELE 16 CE 100 BS	T	125.1/19.3
C477	4030017780	S.CER ECJ0EB1E472K	T	119/12.3
C478	4030017780	S.CER ECJ0EB1E472K	T	115.3/12.2
C479	4510008120	S.ELE 16 CE 100 BS	T	104.8/14.3
C481	4030017460	S.CER ECJ0EB1E102K	B	63.2/122.2
C491	4030016930	S.CER ECJ0EB1A104K	T	60.4/60.1
C492	4030016930	S.CER ECJ0EB1A104K	B	13.5/32.6
C493	4510008870	S.ELE EEE1AA471UP	B	66.3/45.3
C494	4030016930	S.CER ECJ0EB1A104K	T	117.2/92.6
C495	4030016930	S.CER ECJ0EB1A104K	T	117.2/90.7
C496	4030016930	S.CER ECJ0EB1A104K	T	122.4/92.2
C497	4030016930	S.CER ECJ0EB1A104K	T	109.7/82
C498	4030016930	S.CER ECJ0EB1A104K	T	11.4/43.2
C501	4030017420	S.CER ECJ0EC1H470J	T	12.2/31.2
C502	4030017420	S.CER ECJ0EC1H470J	T	29.5/2.8
C503	4030017420	S.CER ECJ0EC1H470J	T	48/99.4
C506	4030016930	S.CER ECJ0EB1A104K	B	26.3/43.3
C507	4030016930	S.CER ECJ0EB1A104K	B	32.9/31
C508	4030016930	S.CER ECJ0EB1A104K	B	40.1/42.7
C509	4030016930	S.CER ECJ0EB1A104K	B	26.2/39
C510	4030016930	S.CER ECJ0EB1A104K	B	26.6/33
C511	4030016930	S.CER ECJ0EB1A104K	B	40.1/34.2
C512	4030017420	S.CER ECJ0EC1H470J	T	92/14.7
C513	4550006250	S.TAN TEESVA 1A 106M8R	B	8.4/59.8
C514	4030016930	S.CER ECJ0EB1A104K	B	11.7/53.5
C515	4030016930	S.CER ECJ0EB1A104K	B	15.5/54.4
C516	4030016930	S.CER ECJ0EB1A104K	B	65.1/69.6
C517	4030016930	S.CER ECJ0EB1A104K	B	15.6/63.1
C518	4030016930	S.CER ECJ0EB1A104K	B	12.4/62.4
C519	4030017460	S.CER ECJ0EB1E102K	B	15.6/59.9
C521	4030016930	S.CER ECJ0EB1A104K	B	18.1/53.6
C522	4030016930	S.CER ECJ0EB1A104K	T	51.2/31.8
C523	4030016930	S.CER ECJ0EB1A104K	T	51.2/33
C524	4030018910	S.CER C1608 JB 0J 475K-T	T	9.5/56
C525	4030018910	S.CER C1608 JB 0J 475K-T	B	25.8/58.3
C526	4030017730	S.CER ECJ0EB1E471K	B	29.8/57.9
C527	4030016790	S.CER ECJ0EB1C103K	B	26.1/50.3
C528	4030017670	S.CER ECJ0EC1H390J	B	37.4/120.7
C529	4030017630	S.CER ECJ0EC1H120J	B	38.3/112.2
C530	4030017420	S.CER ECJ0EC1H470J	T	60.4/62.3
C531	4030017670	S.CER ECJ0EC1H390J	B	93.3/62
C532	4030017670	S.CER ECJ0EC1H390J	B	93.6/52.9
C533	4510008120	S.ELE 16 CE 100 BS	T	125.1/26.4
C534	4030016790	S.CER ECJ0EB1C103K	T	118.5/26.7
C535	4030016790	S.CER ECJ0EB1C103K	B	67.4/101.6

[MAIN UNIT]

REF NO.	ORDER NO.	DESCRIPTION	M.	H/V LOCATION
C536	4030016790	S.CER ECJ0EB1C103K	B	65.7/98.3
C538	4030006860	S.CER C1608 JB 1H 102K-T	T	36.2/145.1
C539	4030017790	S.CER ECJ0EB1E682K	T	22.8/57
C540	4030017730	S.CER ECJ0EB1E471K	T	21.2/56.6
C541	4030016930	S.CER ECJ0EB1A104K	T	22.8/55.4
C542	4030017440	S.CER ECJ0EC1H221J	T	27.1/55
C543	4030016930	S.CER ECJ0EB1A104K	T	56.5/68.9
C544	4030017460	S.CER ECJ0EB1E102K	T	62.4/72.9
C545	4030011060	S.CER GRM31M2C2H4R0CY21L [USA-01]	T	97.6/106.8
	4030011060	S.CER GRM31M2C2H4R0CY21L [EXP-01]		
	4030011050	S.CER GRM31M3C2H3R0CY21L [USA-02]		
	4030011050	S.CER GRM31M3C2H3R0CY21L [EXP-02]		
	4030011060	S.CER GRM31M2C2H4R0CY21L [EUR-01]		
C546	4030018910	S.CER C1608 JB 0J 475K-T	B	40.4/56.7
C547	4030017760	S.CER ECJ0EB1H222K	T	53.7/72.1
C548	4030016930	S.CER ECJ0EB1A104K	T	14.1/120.6
C549	4030017420	S.CER ECJ0EC1H470J	T	23.1/86.8
C550	4030017420	S.CER ECJ0EC1H470J	T	70.1/82.6
C551	4030017330	S.CER ECJ0EF1C104Z	T	114.2/28.9
C552	4030016790	S.CER ECJ0EB1C103K	B	121.9/48.8
C553	4030016930	S.CER ECJ0EB1A104K	B	30.8/19.4
C555	4030016930	S.CER ECJ0EB1A104K	B	69.8/75.5
C556	4030016930	S.CER ECJ0EB1A104K	T	105.2/28.6
C557	4030016930	S.CER ECJ0EB1A104K	T	97/28.6
C558	4550006250	S.TAN TEESVA 1A 106M8R	T	95.1/27.9
C559	4550007080	S.TAN TEESVA 1C 106M8R	T	45.9/75.5
C562	4030017420	S.CER ECJ0EC1H470J	T	38.5/74.2
C563	4030016930	S.CER ECJ0EB1A104K	B	26.5/122.3
C564	4030017570	S.CER ECJ0EC1H040B	B	68.3/131.3
C565	4030017340	S.CER ECJ0EC1H010B	B	47.9/113.5
C566	4030018860	S.CER ECJ0EB0J105K	B	39/72.7
C571	4030017600	S.CER ECJ0EC1H060C	T	64.6/99.1
C572	4030017580	S.CER ECJ0EC1H060C	T	65.6/99.1
C573	4030017580	S.CER ECJ0EC1H060C	T	65.3/97.4
C574	4030017580	S.CER ECJ0EC1H060C	B	64/134.7
C575	4030017420	S.CER ECJ0EC1H470J	B	62.9/132.4
C576	4030017460	S.CER ECJ0EB1E102K	T	67.1/106.5
C577	4030017460	S.CER ECJ0EB1E102K	T	67.1/104.9
C578	4030017200	S.CER GRM31BR32J102KY01L (GHM1030 R)	T	92/126
C579	4550006250	S.TAN TEESVA 1A 106M8R	B	94.7/50.6
C580	4030017420	S.CER ECJ0EC1H470J	T	100.7/73.5
C581	4030018910	S.CER C1608 JB 0J 475K-T	B	46.3/60.9
C582	4030018910	S.CER C1608 JB 0J 475K-T	T	69.7/98.2
C583	4030016930	S.CER ECJ0EB1A104K	B	46.3/58.6
C584	4030016790	S.CER ECJ0EB1C103K	B	54.9/55.3
C585	4030016930	S.CER ECJ0EB1A104K	B	54.9/58.6
C586	4030017730	S.CER ECJ0EB1E471K	B	54.9/56.9
C587	4030016790	S.CER ECJ0EB1C103K	B	52.3/59.8
C588	4030018910	S.CER C1608 JB 0J 475K-T	T	70.9/98.2
C601	4030011060	S.CER GRM31M2C2H4R0CY21L [USA-01]	T	97.6/111.3
	4030011060	S.CER GRM31M2C2H4R0CY21L [EXP-01]		
	4030011060	S.CER GRM31M2C2H4R0CY21L [USA-02]		
	4030011060	S.CER GRM31M2C2H4R0CY21L [EXP-02]		
	4030011070	S.CER GRM31M2C2H5R0CY21L [EUR-01]		
C610	4030018080	S.CER ECJ0EB1H182K	T	63.3/69.6
C612	4030017460	S.CER ECJ0EB1E102K	B	55.7/29.9
C614	4030017730	S.CER ECJ0EB1E471K	B	29/13.2
C615	4030017650	S.CER ECJ0EC1H270J	B	63.2/117.5
C616	4030017460	S.CER ECJ0EB1E102K	T	93.8/64.6
C617	4030017420	S.CER ECJ0EC1H470J	T	60/64.8
C618	4030017420	S.CER ECJ0EC1H470J	T	64.9/53.3
C619	4030017420	S.CER ECJ0EC1H470J	T	74.2/107.7
C620	4030017420	S.CER ECJ0EC1H470J	T	73.7/96.8
C621	4030017420	S.CER ECJ0EC1H470J	T	31.5/72.8
C622	4030018910	S.CER C1608 JB 0J 475K-T	T	64.3/73.2
C623	4030017330	S.CER ECJ0EF1C104Z	B	126.8/16
C624	4030017330	S.CER ECJ0EF1C104Z	B	126.3/20.3
C625	4030017460	S.CER ECJ0EB1E102K	B	126.8/17.2
C626	4510009810	S.ELE EEEFK1E220R	B	129.4/23
C630	4030017420	S.CER ECJ0EC1H470J [EUR-01] only	T	106.4/106.8
C631	4030017580	S.CER ECJ0EC1H060C [EUR-01] only	T	113.5/108.3
C637	4510009680	S.ELE EEEFK1E471P	B	84.9/23.4
J1	6510026770	S.CON AXK540147YG	T	23.1/63.7
J2	6510023092	S.CON 20FLT-SM2-TB(LF)(SN)(M)	T	14.8/15.6
J4	6510023511	S.CON 28FLT-SM2-TB(LF)(SN)	T	70.8/102
J5	651			



**[MAIN UNIT]**

REF NO.	ORDER NO.	DESCRIPTION	M.	H/V LOCATION
W2	7120000470	JUM ERDS2T0		
W4	8900017520	CAB OPC-1783		
EP1	6910015370	S.BEA ACZ1005Y-102-T	B	129.1/48.4
EP2	6910015370	S.BEA ACZ1005Y-102-T	B	117.2/48.4
EP3	6910015370	S.BEA ACZ1005Y-102-T	B	32.4/81.6
EP4	6910016330	S.BEA MMZ1005S 601CT-S	B	30.4/60.5
EP5	6910015370	S.BEA ACZ1005Y-102-T	B	39/74.5
EP6	6910015370	S.BEA ACZ1005Y-102-T	B	37.8/109
EP7	6910016330	S.BEA MMZ1005S 601CT-S	B	40.7/36.7
EP8	6910015370	S.BEA ACZ1005Y-102-T	B	94.5/48.8
EP9	6910016330	S.BEA MMZ1005S 601CT-S	T	48.8/39.3
EP10	6910011560	BEA HF70BB4.5X5X1.6		
EP13	6910011330	TER OT-009 M3		
EP14	6910011330	TER OT-009 M3		

**[CONNECT UNIT]**

REF NO.	ORDER NO.	DESCRIPTION	M.	H/V LOCATION
C601	4030017420	S.CER ECJ0EC1H470J	T	13.8/12.4
C602	4030017400	S.CER ECJ0EC1H220J	T	12.2/12.4
C603	4030017420	S.CER ECJ0EC1H470J	T	16.5/12.4
C604	4030017400	S.CER ECJ0EC1H220J	T	15/14.2
C605	4030017420	S.CER ECJ0EC1H470J	T	17.8/13.9
C606	4030017420	S.CER ECJ0EC1H470J	T	19.4/12.4
C607	4030017420	S.CER ECJ0EC1H470J	T	20.5/13.9
C608	4030017420	S.CER ECJ0EC1H470J	T	22.6/12.4
C609	4030017420	S.CER ECJ0EC1H470J	T	25.5/12.4
C610	4030017420	S.CER ECJ0EC1H470J	T	29.7/12.8
C611	4030017420	S.CER ECJ0EC1H470J	T	31/14.1
C612	4030017420	S.CER ECJ0EC1H470J	T	32.4/12.8
C613	4030017420	S.CER ECJ0EC1H470J	T	33.5/14.1
C614	4030017420	S.CER ECJ0EC1H470J	T	35.2/14.1
C615	4030017420	S.CER ECJ0EC1H470J	T	35.7/12.8
C616	4030017420	S.CER ECJ0EC1H470J	B	35.2/15.6
C617	4030017420	S.CER ECJ0EC1H470J	T	37.5/13.5
C618	4030017420	S.CER ECJ0EC1H470J	T	39.3/12.2
C619	4030017420	S.CER ECJ0EC1H470J	T	39.9/13.4
C620	4030017420	S.CER ECJ0EC1H470J	T	41.3/12.6
C621	4030017420	S.CER ECJ0EC1H470J	T	27.4/13.9
J601	6510026290	S.CON IMSA-9631S-28Y921	B	22.8/16.2
J602	6510023210	CON CD6125SA1J0 <CVI>		
S1	2260003070	S.SWI MINISMDC150F/24-2	B	38.9/18
W601	8900017500	CAB OPC-1852 (P0.5,N28,L90) <TJM>		

M.=Mounted side (T: Mounted on the Top side, B: Mounted on the Bottom side)  
S.=Surface mount





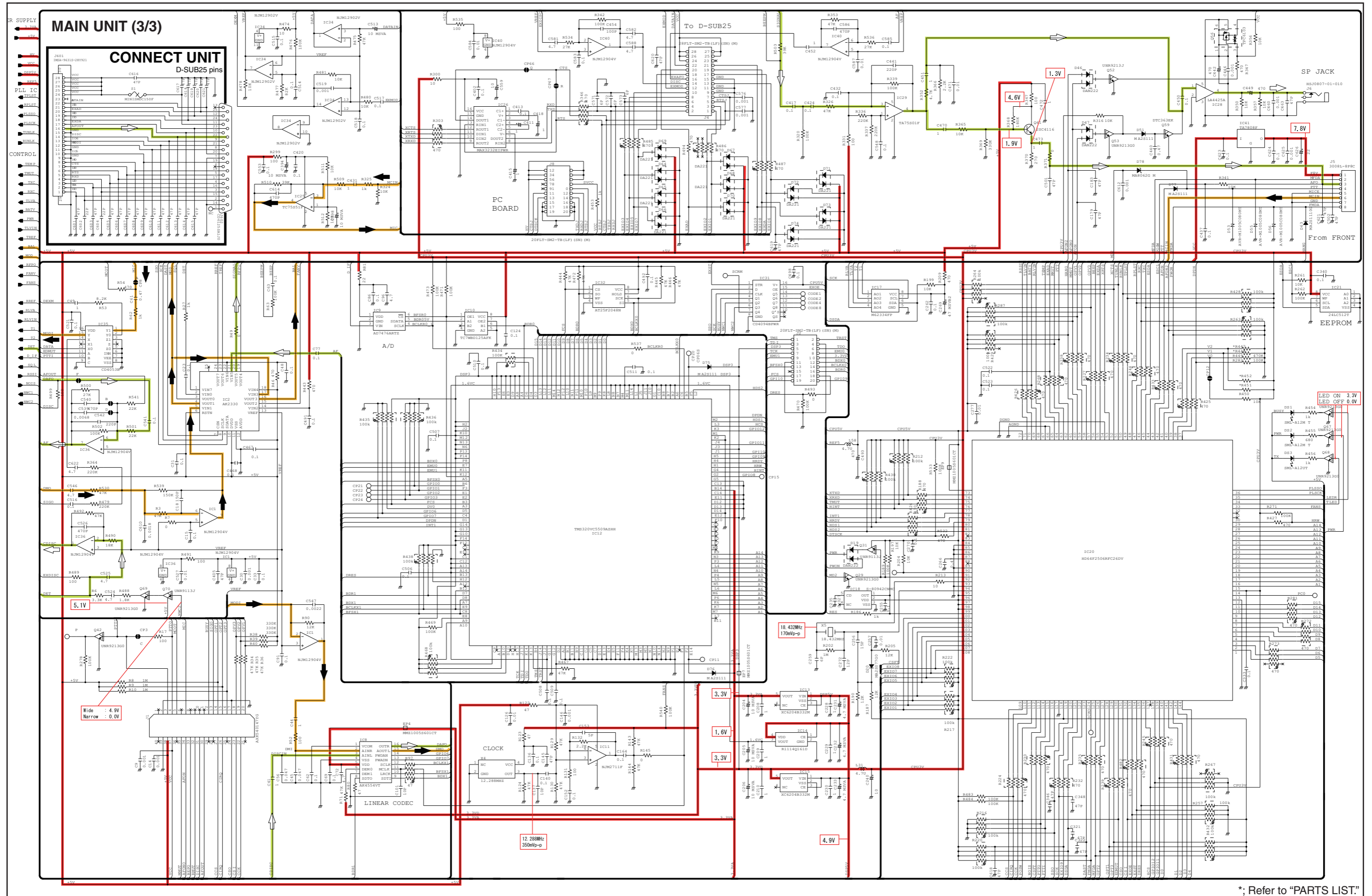

\*; Refer to "PARTS LIST."



Dec. 2008



# SERVICE MANUAL ADDENDUM

---

## UR-FR6000 UR-FR6100

---

### CONTENTS

REPLACEMENT PAGE .....	6-6
PARTS LIST .....	1
VOLTAGE DIAGRAM .....	9

### 6-2 FREQUENCY ADJUSTMENT

- 1) Select an adjustment item using cursor or [↑] / [↓] keys of the PC's keyboard.
- 2) Set or modify the adjustment value as specified using [←] / [→] keys of the PC's keyboard, then push the [ENTER] key.

ADJUSTMENT	ADJUSTMENT CONDITION	OPERATION	ADJUSTMENT ITEM	VALUE
PLL LOCK VOLTAGE -Preparation-	1	-	[LV (RX L)] [LV (RX H)] [LV (TX L)] [LV (TX H)]	36 [0.70V] (for each item)
-Adjust-RX (Band low)	2	• CH. : 1-1 • Receiving	[RX LVA L]	(Automatic adjustment)
RX (Band high)	3	• CH. : 1-2 • Receiving	[RX LVA H]	
TX (Band low)	4	• CH. : 1-1 • Transmitting	[TX LVA L]	
TX (Band high)	5	• CH. : 1-2 • Transmitting	[TX LVA H]	
LOCK VOLTAGE VERIFY	1	• CH. : 1-3 • Receiving	[RX LIVIN] (I/O Check window)	3.0–4.3 V (Verify)
RX (Band low)	2	• CH. : 1-4 • Receiving		3.0–4.0 V (Verify)
RX (Band high)	3	• CH. : 1-3 • Transmitting	[TX LIVIN] (I/O Check window)	2.7–4.2 V (Verify)
TX (Band low)	4	• CH. : 1-4 • Transmitting		
TX FREQUENCY	1	-	[TX Mode]	"1"
	2	• CH. : 1-5 • Transmitting	[TX REF]	469.9000 MHz [Low band] 519.9000 MHz [High band]

• I/O CHECK WINDOW

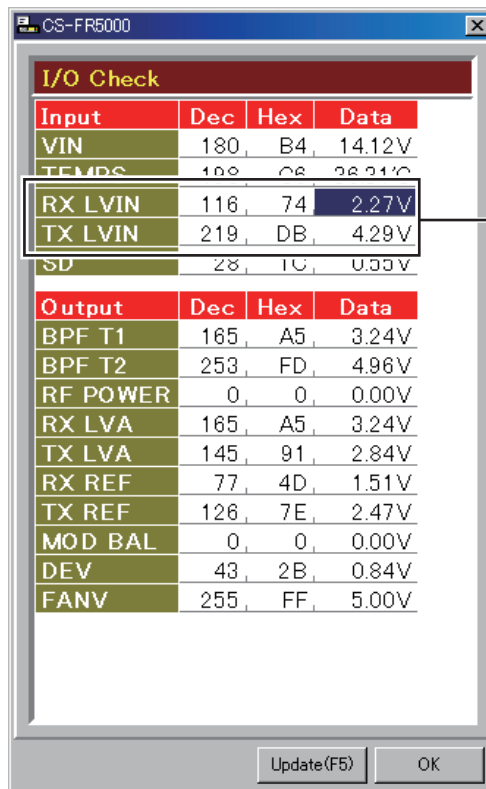

Lock voltage verify

## PARTS LIST

## [MAIN UNIT]

REF NO.	ORDER NO.	DESCRIPTION	M.	H/V LOCATION
IC1	1110005330	S.IC NJM12904V-TE1-#ZZZB	T	58.1/71.4
IC2	1110007290	S.IC AK2330P-L	T	58.7/56.1
IC3	1130010100	S.IC LMX2352TMX/NOPB	B	120.2/43.9
IC4	1130010100	S.IC LMX2352TMX/NOPB	B	28/78.8
IC5	1110003491	S.IC TA31136FNG(D,EL)	B	70.4/82.5
IC7	1110007280	S.IC NJM2716F-TE1-#ZZZB	B	56.8/46.4
IC8	1130012910	S.IC AK4554VTP-E2/P	B	36.2/59.9
IC9	1190002080	S.IC AD7476ARTZ-500RL7	B	49.6/46.4
IC10	1130013040	S.IC TC7WBD125AFK(T5L,F)	B	46.6/49.2
IC11	1110006230	S.IC NJM2711F-TE1-#ZZZB	B	53.1/35
IC12	1140013290	S.IC TMS320CV5509AZHH	B	33.3/37.8
IC13	1180002590	S.REG XC6204B332MR	T	80.9/21.3
IC14	1180003270	S.REG R1114Q161D-TR-F	T	84.4/21.4
IC15	1180002590	S.REG XC6204B332MR	T	87.8/21.3
IC17	1190001340	S.IC M62334FP 600C	T	67.3/61.7
IC18	1110005771	S.IC S-80942CNMC-G9CT2G	T	41.2/52.8
IC20	1140014550	S.IC HD64F2506RFC26DV(EMPTY)	T	33.5/37.6
IC21	1140012950	S.IC 24LC512T-1/SM	T	59.1/21.8
IC22	1150002211	IC RA55H4047M-121 [USA-01]		
	1150002211	IC RA55H4047M-121 [EXP-01]		
	1150002221	IC RA55H4452M-121 [USA-02]		
	1150002221	IC RA55H4452M-121 [EXP-02]		
	1150002092	IC RA30H4047M-121 [EUR-01]		
IC23	1110002751	S.IC TA75S01F(TE85R,F)	T	139.3/125.6
IC25	1130008561	S.IC TC7S551F(TE85L,F)	B	29/16.3
IC26	1120003070	S.IC MAX3232EIPWR	T	42.7/70
IC27	1180001251	S.IC TA7808F(TE16L,Q)	T	116.6/84.1
IC28	1110003091	IC LA4425A-E		
IC29	1110002751	S.IC TA75S01F(TE85R,F)	T	12/123.1
IC30	1110003390	S.IC AN8005M-(E1)	T	114.1/91.8
IC31	1130011760	S.IC CD4094BPWR	T	8.1/45.2
IC32	1130013360	S.IC AT25F2048N-10SU-2.7SL383	B	8.9/36.1
IC34	1110005340	S.IC NJM12902V-TE1-#ZZZB	B	12.2/58.2
IC35	1140013200	S.IC CD4094BPWR	B	20.6/58.2
IC36	1110005330	S.IC NJM12904V-TE1-#ZZZB	B	27.8/55.4
IC37	1120002830	S.IC NJM2125F-TE1-#ZZZB	T	56.6/66.7
IC38	1110006380	S.IC LM2904PWR	T	114.1/23.8
IC39	1180001071	S.IC TA7805F(TE16L,Q)	T	101.2/24.3
IC40	1110005330	S.IC NJM12904V-TE1-#ZZZB	B	50.6/57.2
IC41	1180001251	S.IC TA7808F(TE16L,Q)	B	132/16.7
Q1	1590003230	S.TRA UNR9113J-(TX)	B	53.4/79.7
Q2	1530002851	S.TRA 2SC4116-BL(TE85R,F)	B	34.9/77.7
Q3	1560001360	S.FET 2SK3019 TL	B	66.4/76.6
Q4	1560000541	S.FET 2SK880-Y(T5RICOM,F)	B	88.8/41.5
Q5	1560000541	S.FET 2SK880-Y(T5RICOM,F)	B	33.3/107.5
Q6	1560000541	S.FET 2SK880-Y(T5RICOM,F)	B	29.6/101.3
Q7	1530002601	S.TRA 2SC4215-O(TE85R,F)	B	72.9/92.5
Q8	1560000541	S.FET 2SK880-Y(T5RICOM,F)	B	92.7/47.7
Q9	1560001360	S.FET 2SK3019 TL	B	39.5/104.5
Q10	1530002851	S.TRA 2SC4116-BL(TE85R,F)	B	88.8/44.6
Q11	1530002851	S.TRA 2SC4116-BL(TE85R,F)	B	29.6/104.4
Q12	1590003230	S.TRA UNR9113J-(TX)	B	65.6/101.6
Q13	1530002851	S.TRA 2SC4116-BL(TE85R,F)	B	88.8/47.7
Q14	1530002851	S.TRA 2SC4116-BL(TE85R,F)	B	29.6/107.5
Q15	1530002851	S.TRA 2SC4116-BL(TE85R,F)	B	92.7/44.6
Q16	1530002851	S.TRA 2SC4116-BL(TE85R,F)	B	33.3/104.5
Q19	1530002601	S.TRA 2SC4215-O(TE85R,F)	B	63.2/106.8
Q20	1530002920	S.TRA 2SC4226-T1 R25	B	38.8/123.1
Q21	1530002920	S.TRA 2SC4226-T1 R25	B	39.6/114.5
Q22	1530002920	S.TRA 2SC4226-T1 R25	B	94.6/64.3
Q23	1530002920	S.TRA 2SC4226-T1 R25	B	95.2/55.4
Q24	1530003311	S.TRA 2SC5107-O(TE85R,F)	B	100.5/58.6
Q25	1530003311	S.TRA 2SC5107-O(TE85R,F)	B	44.9/116.2
Q26	1590001400	S.TRA XP1214(TX)	B	40.5/117.8
Q27	1590001400	S.TRA XP1214(TX)	B	96/59.6
Q28	1590003290	S.TRA UNR9213J-(TX)	B	93.3/59.6
Q29	1590003290	S.TRA UNR9213J-(TX)	T	57.2/41.9
Q30	1590003290	S.TRA UNR9213J-(TX)	B	37.8/117.8
Q31	1590003230	S.TRA UNR9113J-(TX)	T	57.2/39.8
Q32	1530003980	S.TRA 2SC5700WB-TR-E	B	46.5/109.1
Q33	1530003980	S.TRA 2SC5700WB-TR-E	B	102.1/53.4
Q34	1530003311	S.TRA 2SC5107-O(TE85R,F)	B	46.2/123.1
Q35	1530003311	S.TRA 2SC5107-O(TE85R,F)	B	101.9/64.4
Q36	1580000731	S.FET 3SK293(TE85L,F)	B	47.3/136.1
Q37	1530003311	S.TRA 2SC5107-O(TE85R,F)	B	132.5/84.5
Q38	1530002680	S.FET 2SC3357-T1	B	138.1/88.8
Q39	1560000841	S.FET 2SK1829(TE85R,F)	B	53.2/140.8
Q40	1590001190	S.TRA XP6501-(TX)AB	T	101.6/87.4
Q41	1520000460	S.TRA 2SB1132 T100 R	T	101.6/82.8
Q42	1590003290	S.TRA UNR9213J-(TX)	T	13.3/67.6
Q43	1590003290	S.TRA UNR9213J-(TX)	T	138.8/122.9
Q44	1590003290	S.TRA UNR9213J-(TX)	T	122.8/79.2
Q45	1540000550	S.TRA 2SD1664 T100Q	T	117/76.3
Q46	1530002851	S.TRA 2SC4116-BL(TE85R,F)	T	137.4/120.3
Q48	1510000920	S.TRA 2SA1577 T106 Q	T	101.5/77.8
Q49	1590003290	S.TRA UNR9213J-(TX)	T	102.2/73.7
Q52	1590003290	S.TRA UNR9213J-(TX)	T	10.9/131.6
Q53	1590003290	S.TRA UNR9213J-(TX)	T	10.9/129.6
Q56	1590003321	S.FET TPC6103(TE85L,F)	T	7.6/132.6
Q57	1550000190	S.FET 2SJ506STR-E	T	125.2/99.6
Q58	1590003290	S.TRA UNR9213J-(TX)	T	130.2/102.1
Q59	1590000990	S.TRA DTC363EK T146	T	7.6/127.6
Q61	1530002851	S.TRA 2SC4116-BL(TE85R,F)	T	6.8/118.4
Q62	1540000441	S.TRA 2SD1619T-TD-E	T	118.4/18.5
Q63	1560000990	S.FET PMBFJ310	B	66.3/110
Q64	1560000990	S.FET PMBFJ310	B	63.3/110

## [MAIN UNIT]

REF NO.	ORDER NO.	DESCRIPTION	M.	H/V LOCATION
Q65	1530003311	S.TRA 2SC5107-O(TE85R,F)	B	59.6/123.7
Q66	1590003290	S.TRA UNR9213J-(TX)	B	94.9/4.7
Q67	1590003290	S.TRA UNR9213J-(TX)	B	124.9/4.7
Q68	1590003290	S.TRA UNR9213J-(TX)	B	109.9/4.7
Q69	1590003290	S.TRA UNR9213J-(TX)	T	9.5/53.3
Q70	1590003230	S.TRA UNR9113J-(TX)	T	9.5/51
D1	1750001070	S.DIO DAN235ETL	B	57.3/78.6
D2	1750001070	S.DIO DAN235ETL	B	50/79.7
D3	1790001621	S.DIO 1SV308(TPL3,F)	B	70.3/93.4
D4	1790001621	S.DIO 1SV308(TPL3,F)	B	62.8/93.4
D7	1750001150	S.VAR HVC383BTRF-E	B	30.8/122.3
D8	1750001150	S.VAR HVC383BTRF-E	B	30.6/112.7
D9	1750001150	S.VAR HVC383BTRF-E	B	85.6/63.5
D10	1750001150	S.VAR HVC383BTRF-E	B	85.7/53.3
D11	1790001621	S.DIO 1SV308(TPL3,F)	B	63.5/103.1
D12	1790001621	S.DIO 1SV308(TPL3,F)	B	62.7/101.1
D13	1750000711	S.VAR HVC350BTRF-E	B	87.3/67.8
D14	1750000711	S.VAR HVC350BTRF-E	B	87.1/55.4
D15	1750000711	S.VAR HVC350BTRF-E	B	32.6/125.4
D16	1750000711	S.VAR HVC350BTRF-E	B	32/114.5
D17	1720000570	S.VAR MA368(TX)	B	94.6/66.6
D18	1720000570	S.VAR MA368(TX)	B	91.4/57.7
D19	1750000520	S.DIO DAN222TL	T	59.6/39.8
D20	1790001260	S.DIO MA2S077-(TX)	T	38.9/57.8
D21	1750000711	S.VAR HVC350BTRF-E	B	66.1/135.8
D22	1750000711	S.VAR HVC350BTRF-E	B	62.9/135.8
D24	1750000711	S.VAR HVC350BTRF-E	B	56.1/135.9
D27	1790001250	S.DIO MA2S111-(TX)	B	57.2/140.4
D28	1750000711	S.VAR HVC350BTRF-E	B	35.9/134.4
D29	1750000711	S.VAR HVC350BTRF-E	B	37.1/134.4
D31	1750000711	S.VAR HVC350BTRF-E	B	32.4/136.5
D32	1750000711	S.VAR HVC350BTRF-E	B	32.4/135.3
D33	1790001240	S.DIO MA2S728-(TX)	B	37.8/144.2
D34	1790001260	S.DIO MA2S077-(TX)	B	85.4/137.8
D38	1750001360	S.DIO L709CER (9401)	B	87.8/135.6
D40	1750000370	S.DIO DA221 TL	T	112.6/77
D44	1710001061	DIO L407CDB		
D45	1790001211	S.DIO 1SS375-TL-E	B	96.3/138.1
D46	1750000520	S.DIO DAN222TL	T	13.3/131.1
D47	1750000520	S.DIO DAN222TL	T	13.2/129.1
D48	1790000660	S.DIO MA728(TX)	B	121.1/142.5
D49	1790000660	S.DIO MA728(TX)	B	140.6/133
D51	1790001250	S.DIO MA2S111-(TX)	T	10.5/127.1
D53	1790001810	S.VAR AVR-M1005C080MTABB	T	32.5/11.5
D55	1790001810	S.VAR AVR-M1005C080MTABB	T	30.5/11.5
D56	1790001810	S.VAR AVR-M1005C080MTABB	B	33.2/22.0
D59	1790000700	DIO DSA3A1		
D61	1160000070	S.DIO DAN202K T146	T	118.4/14.3
D62	1750000431	S.DIO HSB88WSTR-E	B	68.3/123.3
D63	1790001250	S.DIO MA2S111-(TX)	B	34.1/20.7
D64	1750000370	S.DIO DA221 TL	T	63.2/93.9
D65	1750000370	S.DIO DA221 TL	T	65.2/93.9
D66	1750000370	S.DIO DA221 TL	T	67.2/93.9
D67	1750000370	S.DIO DA221 TL	T	62.5/105.6
D68	1750000370	S.DIO DA221 TL	T	60.5/104.7
D69	1750000370	S.DIO DA221 TL	T	69.2/93.9
D70	1750000370	S.DIO DA221 TL	T	71.2/93.9
D71	1750000370	S.DIO DA221 TL	T	69.4/109.5
D72	1750000370	S.DIO DA221 TL	T	71.5/109.5
D73	1750000370	S.DIO DA221 TL	T	73.5/109.5
D74	1750000370	S.DIO DA221 TL	T	75.6/109.5
D75	1790001250	S.DIO MA2S111-(TX)	B	41/38.6
D76	1790001250	S.DIO MA2S111-(TX)	B	26.4/41.3
D77	1790001250	S.DIO MA2S111-(TX)	B	49.2/29.9
D78	1730002360	S.ZEN MA8062-M(TX)	B	52.3/29.9
F11	2020001520	CER CFWLA450KFFA-B0 (CFWS450F)		
F12	2020001460	CER CFWLA450KHFA-B0 (CFWS450HT)		
F13	2030000500	S.MON DSF753SFB 46.35 MHz(FL-401)	B	72/101
F14	2030000670	S.MON DSF753SFB 46.35 MHz(FL-420)	B	63.4/91.1
F15	2040001440	S.LC NFE31PT152Z1E9L (NFM60R20T152)	T	114.2/110.3
F16	2040001440	S.LC NFE31PT152Z1E9L (NFM60R20T152)	T	114.2/113.4
F17	2040001440	S.LC NFE31PT152Z1E9L (NFM60R20T152)	T	114.2/116.5
X1	6050012380	S.XTA CR-826 DSA535SD 15.3 MHz	B	128.6/45.3
X2	6050012380	S.XTA CR-826 DSA535SD 15.3 MHz	B	35.6/72.3
X3	6070000300	S.DIS JTBM450CX24 <J>E	B	63.5/83.5
X4	6050012350	S.XTA CR-817 DSB321SC 12.288 MHz	B	52.8/38.2
X5	6050012680	S.XTA CR-858(SMD-49/18.432 MHz)	T	46.9/52.7
L1	6200004660	S.COI MLF1608A 1R8K-T	B	115.6/39.2
L2	6200004660	S.COI MLF1608A 1R8K-T	B	23.6/82.4
L3	6200004480	S.COI MLF1608D R82K-T	B	39.4/79.3
L4	6200003540	S.COI MLF1608D R22K-T	B	36.9/76.9
L5	6200005671	S.COI ELJRE 12NGFA [USA-01]	B	102.7/46.7
	6200005671	S.COI ELJRE 12NGFA [EXP-01]		
	6200005661	S.COI ELJRE 10NGFA [USA-02]		
	6200005661	S.COI ELJRE 10NGFA [EXP-02]		
	6200005671	S.COI ELJRE 12NGFA [EUR-01]		
L6	6200005671	S.COI ELJRE 12NGFA	B	44.6/99.3

M.=Mounted side (T: Mounted on the Top side, B: Mounted on the Bottom side)  
S.=Surface mount

[MAIN UNIT]

REF NO.	ORDER NO.	DESCRIPTION	M.	H/V LOCATION
L8	6200004741	S.COI NLV25T-1R2J	B	28.5/121.7
L9	6200004741	S.COI NLV25T-1R2J	B	28.5/124.9
L10	6200004741	S.COI NLV25T-1R2J	B	28.5/114.1
L11	6200004741	S.COI NLV25T-1R2J	B	83.7/63.1
L12	6200004741	S.COI NLV25T-1R2J	B	83.7/54.6
L13	6200004741	S.COI NLV25T-1R2J	B	30.6/117.2
L14	6200004741	S.COI NLV25T-1R2J	B	84.2/66.2
L15	6200004741	S.COI NLV25T-1R2J	B	84.2/57.7
L18	6200009260	S.COI C3328A-5N0J-A	B	88.7/63.1
L19	6200009260	S.COI C3328A-5N0J-A	B	89.8/54
L20	6200009390	S.COI C3328A-8N0J-A	B	33.2/121.7
L21	6200009390	S.COI C3328A-8N0J-A	B	34.7/113.1
L22	6200003550	S.COI MLF1608A 4R7K-T	B	73.4/109.9
L23	6200002861	S.COI NLV25T-4R7J	B	57.6/108.9
L24	6200010740	S.COI C2520C-R27G-A	B	70/109.1
L25	6200004741	S.COI NLV25T-1R2J	B	97.1/64.6
L26	6200004741	S.COI NLV25T-1R2J	B	98.1/53.9
L27	6130002961	S.COI #617DB-1327=P3	B	68.3/117
L28	6200005711	S.COI ELJRE 27NGFA	B	62.3/123.6
L29	6200005721	S.COI ELJRE 33NGFA	B	102.6/58.6
L30	6200005721	S.COI ELJRE 33NGFA	B	46.9/116.2
L31	6200002861	S.COI NLV25T-4R7J	T	91.1/19.9
L32	6130002961	S.COI #617DB-1327=P3	B	68.3/128.7
L33	6200005671	S.COI ELJRE 12NGFA	B	47.3/107.1
L34	6200005711	S.COI ELJRE 27NGFA [USA-01]	B	61.1/117.5
	6200005711	S.COI ELJRE 27NGFA [EXP-01]		
	6200005691	S.COI ELJRE 18NGFA [USA-02]		
	6200005691	S.COI ELJRE 18NGFA [EXP-02]		
	6200005711	S.COI ELJRE 27NGFA [EUR-01]		
L35	6200005671	S.COI ELJRE 12NGFA [USA-01]	B	102.7/51.6
	6200005671	S.COI ELJRE 12NGFA [EXP-01]		
	6200005661	S.COI ELJRE 10NGFA [USA-02]		
	6200005661	S.COI ELJRE 10NGFA [EXP-02]		
	6200005671	S.COI ELJRE 12NGFA [EUR-01]		
L36	6200005711	S.COI ELJRE 27NGFA	B	44.3/123.1
L37	6200005711	S.COI ELJRE 27NGFA [USA-01]	B	61.1/120.1
	6200005711	S.COI ELJRE 27NGFA [EXP-01]		
	6200005691	S.COI ELJRE 18NGFA [USA-02]		
	6200005691	S.COI ELJRE 18NGFA [EXP-02]		
	6200005711	S.COI ELJRE 27NGFA [EUR-01]		
L38	6200005711	S.COI ELJRE 27NGFA	B	100/64.4
L39	6200009320	S.COI C3328A-12NG-A	B	70.8/137.3
L40	6200009320	S.COI C3328A-12NG-A	B	59.5/135.7
L41	6200009320	S.COI C3328A-12NG-A	B	51.4/136.3
L42	6200005711	S.COI ELJRE 27NGFA	B	134.7/83.8
L43	6200005711	S.COI ELJRE 27NGFA	B	142/87.1
L44	6200010290	S.COI C6328A-22NG-A [USA-01]	B	41.9/136.2
	6200010290	S.COI C6328A-22NG-A [EXP-01]		
	6200013490	S.COI C6328A-17NG-A [USA-02]		
	6200013490	S.COI C6328A-17NG-A [EXP-02]		
	6200010290	S.COI C6328A-22NG-A [EUR-01]		
L45	6200005641	S.COI ELJRE 6N8ZF-A	B	142.7/90.6
L46	6200005691	S.COI ELJRE 18NGFA [USA-01]	B	142/94.6
	6200005691	S.COI ELJRE 18NGFA [EXP-01]		
	6200005691	S.COI ELJRE 18NGFA [USA-02]		
	6200005691	S.COI ELJRE 18NGFA [EXP-02]		
	6200005671	S.COI ELJRE 12NGFA [EUR-01]		
L47	6200010290	S.COI C6328A-22NG-A [USA-01]	B	34.8/140.3
	6200010290	S.COI C6328A-22NG-A [EXP-01]		
	6200013490	S.COI C6328A-17NG-A [USA-02]		
	6200013490	S.COI C6328A-17NG-A [EXP-02]		
	6200010290	S.COI C6328A-22NG-A [EUR-01]		
L48	6200010100	S.COI C2012C-33NG-A	B	39.7/142.2
L49	6200010040	S.COI AS100340-10N	B	95.5/119.7
L50	6200005691	S.COI ELJRE 18NGFA	B	88/137.7
L52	6200010420	S.COI FHW1210HC 1R0JGT <JJE>	B	86.6/122.3
L53	6200010150	S.COI AS080340-15N	B	92.5/134.3
L54	6200010150	S.COI AS080340-15N	B	99.7/133.8
L55	6200010150	S.COI AS080340-15N	B	107.5/135.8
L56	6200010150	S.COI AS080340-15N	B	114.4/138.9
L57	6200010150	S.COI AS080340-15N	B	144.6/142.1
L58	6200002861	S.COI NLV25T-4R7J	T	55.4/37.5
L59	6200010420	S.COI FHW1210HC 1R0JGT <JJE>	B	147.1/146.2
L60	6200010420	S.COI FHW1210HC 1R0JGT <JJE>	B	24.5/145
L61	6200002961	S.COI NLV32T-4R7J	T	118.4/23.8
L65	6200004741	S.COI NLV25T-1R2J	B	41.3/123.3
L66	6200004741	S.COI NLV25T-1R2J	B	42.8/113.5
R1	7030005700	S.RES ERJ2GEJ 274 X (270K)	T	54.5/63.5
R2	7030005050	S.RES ERJ2GEJ 103 X (10K)	T	59/61.8
R3	7030005240	S.RES ERJ2GEJ 473 X (47K)	T	62.4/69.6
R4	7030007340	S.RES ERJ2GEJ 153 X (15K)	B	57.3/80.1
R6	7030007300	S.RES ERJ2GEJ 332 X (3.3K)	T	9.5/57.1
R7	7030010040	S.RES ERJ2GEJ-JPW	T	61.6/66.3
R8	7030005160	S.RES ERJ2GEJ 105 X (1M)	T	24.9/70.4
R9	7030005160	S.RES ERJ2GEJ 105 X (1M)	T	25.8/70.4
R10	7030005160	S.RES ERJ2GEJ 105 X (1M)	T	26.7/70.4
R12	7510001730	S.THE ERTJJOEP 473J	B	129.1/49.3
R13	7030005090	S.RES ERJ2GEJ 104 X (100K)	B	130.8/49.3
R15	7030007340	S.RES ERJ2GEJ 153 X (15K)	B	54.5/78.3
R17	7030004980	S.RES ERJ2GEJ 101 X (100)	T	19.8/68.8
R18	7030007340	S.RES ERJ2GEJ 153 X (15K)	B	55.3/79.2
R20	7030008300	S.RES ERJ2GEJ 184 X (180K)	B	56.2/63.5
R22	7410001130	S.ARR EXB28V102JX	B	122.6/39
R23	7410001130	S.ARR EXB28V102JX	B	23.1/76.3
R25	7030004970	S.RES ERJ2GEJ 470 X (47)	B	65.3/79.4
R26	7030010040	S.RES ERJ2GEJ-JPW	T	57.8/64.5
R27	7030005120	S.RES ERJ2GEJ 102 X (1K)	T	57.8/51
R29	7030007570	S.RES ERJ2GEJ 122 X (1.2K)	B	35.8/75.5
R30	7030007340	S.RES ERJ2GEJ 153 X (15K)	B	52.8/81.1
R32	7030007340	S.RES ERJ2GEJ 153 X (15K)	B	51.2/78.3
R33	7030007340	S.RES ERJ2GEJ 153 X (15K)	B	48.4/78.2
R34	7030005240	S.RES ERJ2GEJ 473 X (47K)	T	27.1/68.1

[MAIN UNIT]

REF NO.	ORDER NO.	DESCRIPTION	M.	H/V LOCATION
R35	7030005240	S.RES ERJ2GEJ 473 X (47K)	T	28/68.1
R36	7030005240	S.RES ERJ2GEJ 473 X (47K)	T	28.9/68.1
R38	7030005230	S.RES ERJ2GEJ 334 X (330K)	T	27.6/70.4
R39	7030005230	S.RES ERJ2GEJ 334 X (330K)	T	28.6/70.4
R40	7030005230	S.RES ERJ2GEJ 334 X (330K)	T	29.5/70.4
R41	7030005240	S.RES ERJ2GEJ 473 X (47K)	B	68.2/78.2
R42	7030007060	S.RES ERJ2GEJ 684X (680K)	B	34.6/75.9
R43	7030007290	S.RES ERJ2GEJ 222 X (2.2K)	B	62.8/77.3
R44	7030005030	S.RES ERJ2GEJ 152 X (1.5K)	B	71.4/78.2
R45	7030004970	S.RES ERJ2GEJ 470 X (47)	B	64.6/75.5
R46	7030005000	S.RES ERJ2GEJ 471 X (470)	T	52.7/57.1
R47	7030005290	S.RES ERJ2GEJ 682 X (6.8K)	B	64.6/76.4
R48	7030005030	S.RES ERJ2GEJ 152 X (1.5K)	B	62.8/76.4
R49	7030010040	S.RES ERJ2GEJ-JPW	T	55.2/57
R52	7030004980	S.RES ERJ2GEJ 101 X (100)	B	34.1/56.4
R53	7030005210	S.RES ERJ2GEJ 822 X (8.2K)	B	16.8/57.6
R54	7030005000	S.RES ERJ2GEJ 471 X (470)	B	19.4/64.3
R56	7030004970	S.RES ERJ2GEJ 470 X (47)	B	121.9/50.4
R57	7030005040	S.RES ERJ2GEJ 472 X (4.7K)	B	62.8/75.5
R58	7030008290	S.RES ERJ2GEJ 183 X (18K)	B	56.5/49.8
R59	7030008290	S.RES ERJ2GEJ 183 X (18K)	B	57.4/49
R60	7030005000	S.RES ERJ2GEJ 471 X (470)	B	33.1/75.2
R62	7030005120	S.RES ERJ2GEJ 102 X (1K)	T	18.5/62.5
R63	7030005090	S.RES ERJ2GEJ 104 X (100K)	T	55.5/60
R65	7030005000	S.RES ERJ2GEJ 471 X (470)	B	125.1/47.3
R66	7030004980	S.RES ERJ2GEJ 101 X (100)	B	56.5/50.6
R68	7030005040	S.RES ERJ2GEJ 472 X (4.7K)	B	67.5/86.7
R69	7030005120	S.RES ERJ2GEJ 102 X (1K)	B	32.7/83
R71	7030005240	S.RES ERJ2GEJ 473 X (47K)	B	31/62.6
R72	7030004980	S.RES ERJ2GEJ 101 X (100)	B	57.6/44.2
R75	7030005110	S.RES ERJ2GEJ 224 X (220K)	B	39.9/71.1
R76	7030005120	S.RES ERJ2GEJ 102 X (1K)	B	91/41.5
R77	7030005580	S.RES ERJ2GEJ 560 X (56)	B	119.7/48.8
R78	7030005120	S.RES ERJ2GEJ 102 X (1K)	B	29.6/99.3
R79	7030005580	S.RES ERJ2GEJ 560 X (56)	B	32.7/79.5
R80	7030004970	S.RES ERJ2GEJ 470 X (47)	B	23.5/41.1
R81	7030007250	S.RES ERJ2GEJ 220 X (22)	B	49.9/50.5
R82	7030008400	S.RES ERJ2GEJ 182 X (1.8K)	B	56/44.2
R84	7030007290	S.RES ERJ2GEJ 222 X (2.2K)	B	95.4/45.4
R85	7030007290	S.RES ERJ2GEJ 222 X (2.2K)	B	36.9/105.6
R87	7030005090	S.RES ERJ2GEJ 104 X (100K)	B	73.7/81.1
R88	7030005530	S.RES ERJ2GEJ 100 X (10)	B	39/71.1
R89	7030008400	S.RES ERJ2GEJ 182 X (1.8K)	B	67.1/83.2
R90	7030008010	S.RES ERJ2GEJ 123 X (12K)	T	54.5/73.3
R91	7030007570	S.RES ERJ2GEJ 122 X (1.2K)	B	94.5/45.4
R92	7030005290	S.RES ERJ2GEJ 682 X (6.8K)	B	86.7/51.9
R93	7030007570	S.RES ERJ2GEJ 122 X (1.2K)	B	35.1/105.6
R94	7030005290	S.RES ERJ2GEJ 682 X (6.8K)	B	28/93.3
R97	7410001170	S.ARR EXB28V470JX	B	42.9/49.9
R98	7030005530	S.RES ERJ2GEJ 100 X (10)	B	70.7/90.4
R99	7030005110	S.RES ERJ2GEJ 224 X (220K)	B	70.7/91.3
R100	7030005600	S.RES ERJ2GEJ 273 X (27K)	B	69.1/92.3
R101	7030004980	S.RES ERJ2GEJ 101 X (100)	B	86.7/43.7
R102	7030004980	S.RES ERJ2GEJ 101 X (100)	B	31.5/105.6
R103	7030004980	S.RES ERJ2GEJ 101 X (100)	B	27.8/103.9
R104	7030005050	S.RES ERJ2GEJ 103 X (10K)	B	86.7/45.4
R105	7030005050	S.RES ERJ2GEJ 103 X (10K)	B	31.5/109
R106	7030005050	S.RES ERJ2GEJ 103 X (10K)	B	27.8/105.6
R107	7030004980	S.RES ERJ2GEJ 101 X (100)	B	90.8/45.4
R108	7030005030	S.RES ERJ2GEJ 152 X (1.5K)	B	90.8/43.7
R109	7030005090	S.RES ERJ2GEJ 104 X (100K)	B	65.7/100.1
R110	7030005810	S.RES RR0510P-152-D (1.5K)	B	31.5/103.9
R111	7030005090	S.RES ERJ2GEJ 104 X (100K)	B	37.8/105.6
R112	7030005220	S.RES ERJ2GEJ 223 X (22K)	B	86.7/47.1
R113	7030005220	S.RES ERJ2GEJ 223 X (22K)	B	27.8/107.3
R114	7030007300	S.RES ERJ2GEJ 332 X (3.3K)	B	69.4/94.8
R115	7030007300	S.RES ERJ2GEJ 332 X (3.3K)	B	66.8/96.2
R116	7030005050	S.RES ERJ2GEJ 103 X (10K)	B	90.8/48.8
R117	7030005120	S.RES ERJ2GEJ 102 X (1K)	B	90.8/47.1
R118	7030007280	S.RES ERJ2GEJ 331 X (330)	B	72.8/94.8
R119	7030007270	S.RES ERJ2GEJ 151 X (150)	B	67.2/90
R120	7030005800	S.RES RR0510P-102-D (1K)	B	31.5/107.3
R121	7030009820	S.RES RR0510P-681-D (680)	B	26.2/109
R122	7030004970	S.RES ERJ2GEJ 470 X (47)	B	56.6/33.9
R123	7030004970	S.RES ERJ2GEJ 470 X (47)	B	49.5/38.5
R124	7030005240	S.RES ERJ2GEJ 473 X (47K)	B	55.3/38.3
R125	7030007280	S.RES ERJ2GEJ 331 X (330)	B	82.6/51
R126	7030007290	S.RES ERJ2GEJ 222 X (2.2K)	B	94.5/43.7
R127	7030005700	S.RES ERJ2GEJ 274 X (270K)	T	61.2/51
R128	7030007290	S.RES ERJ2GEJ 222 X (2.2K)	T	35.1/103.9
R129	7030005240	S.RES ERJ2GEJ 473 X (47K)	B	55.3/35.1
R130	7030005240	S.RES ERJ2GEJ 473 X (47K)	B	56.2/36.7
R131	7030004980	S.RES ERJ2GEJ 101 X (100)	B	54.2/32.4
R132	7030007290	S.RES ERJ2GEJ 222 X (2.2K)	B	50.8/34.9
R133	7030007280	S.RES ERJ2GEJ 331 X (330)	B	67.5/104.4
R134	7030007270	S.RES ERJ2GEJ 151 X (150)	B	62.7/97.1
R136	7030005110	S.RES ERJ2GEJ 224 X (220K)	B	81.7/6



[MAIN UNIT]

REF NO.	ORDER NO.	DESCRIPTION	M.	H/V LOCATION
R157	7030005530	S.RES ERJ2GEJ 100 X (10)	B	92.4/66.6
R158	7030005530	S.RES ERJ2GEJ 100 X (10)	B	88.9/57.2
R159	7030005530	S.RES ERJ2GEJ 100 X (10)	B	65.2/106.1
R160	7030010040	S.RES ERJ2GEJ-JPW	B	36.8/123.7
R161	7030006020	S.RES RR0510P-682-D (6.8K)	B	37.6/113.5
R162	7030010040	S.RES ERJ2GEJ-JPW	B	37.6/115.3
R163	7030006020	S.RES RR0510P-682-D (6.8K)	B	92.4/62
R164	7030006020	S.RES RR0510P-682-D (6.8K)	B	92.7/52.9
R165	7030009320	S.RES ERJ2GEJ 4R7 X (4.7)	B	92.4/65.2
R166	7030009320	S.RES ERJ2GEJ 4R7 X (4.7)	B	93.1/56.3
R167	7030007250	S.RES ERJ2GEJ 220 X (22)	B	58.3/111.1
R168	7030006020	S.RES RR0510P-682-D (6.8K)	B	92.4/63.4
R169	7030006020	S.RES RR0510P-682-D (6.8K)	B	93.1/54.5
R171	7030011920	S.RES RR0510P-561-D (560)	B	41/120.7
R172	7030009820	S.RES RR0510P-681-D (680)	B	97/62
R173	7030009820	S.RES RR0510P-681-D (680)	B	97/56.5
R174	7030009820	S.RES RR0510P-681-D (680)	B	41.4/115.7
R175	7030005530	S.RES ERJ2GEJ 100 X (10)	B	73.6/108.8
R176	7030005310	S.RES ERJ2GEJ 124 X (120K)	B	100.5/56.8
R177	7030005310	S.RES ERJ2GEJ 124 X (120K)	B	44.9/114.4
R178	7030004980	S.RES ERJ2GEJ 101 X (100)	B	100.5/55.9
R179	7030004980	S.RES ERJ2GEJ 101 X (100)	B	44.9/113.5
R180	7030005050	S.RES ERJ2GEJ 103 X (10K)	B	36/109
R181	7030005050	S.RES ERJ2GEJ 103 X (10K)	B	95.4/48.8
R182	7030007300	S.RES ERJ2GEJ 332 X (3.3K)	B	68.5/107
R185	7030010040	S.RES ERJ2GEJ-JPW	B	62.3/117.5
R186	7030005120	S.RES ERJ2GEJ 102 X (1K)	T	39.2/50.7
R187	7030008010	S.RES ERJ2GEJ 123 X (12K)	T	41.5/55.9
R188	7410001150	S.ARR EXB28V471JX	T	48.5/41.1
R189	7030005090	S.RES ERJ2GEJ 104 X (100K)	T	55.6/39.5
R190	7030008010	S.RES ERJ2GEJ 123 X (12K)	T	43.1/55.9
R191	7030005000	S.RES ERJ2GEJ 471 X (470)	B	44/109.1
R192	7030005110	S.RES ERJ2GEJ 224 X (220K)	B	44.9/109.1
R194	7030004980	S.RES ERJ2GEJ 101 X (100)	B	100.5/51.7
R195	7030005110	S.RES ERJ2GEJ 224 X (220K)	B	100.5/53.4
R196	7030007260	S.RES ERJ2GEJ 330 X (33)	B	48/120.7
R197	7030005050	S.RES ERJ2GEJ 103 X (10K)	T	40.5/50.6
R198	7030007260	S.RES ERJ2GEJ 330 X (33)	B	103.7/62
R199	7030005050	S.RES ERJ2GEJ 103 X (10K)	T	67.6/57.5
R200	7030004980	S.RES ERJ2GEJ 101 X (100)	B	43.1/122.6
R201	7030005070	S.RES ERJ2GEJ 683 X (68K)	B	48/122.6
R202	7030005160	S.RES ERJ2GEJ 105 X (1M)	T	41.4/48.6
R204	7030005050	S.RES ERJ2GEJ 103 X (10K)	T	54.7/39.5
R205	7030008010	S.RES ERJ2GEJ 123 X (12K)	T	34.5/57.9
R207	7030005070	S.RES ERJ2GEJ 683 X (68K)	B	103.7/64
R208	7030010040	S.RES ERJ2GEJ-JPW	B	46.2/120.7
R209	7030005000	S.RES ERJ2GEJ 471 X (470)	T	67.6/56
R212	7410001140	S.ARR EXB28V104JX	T	52.3/41.1
R213	7030005530	S.RES ERJ2GEJ 100 X (10)	T	41.4/47.7
R214	7030004980	S.RES ERJ2GEJ 101 X (100)	B	98.9/64
R215	7030010040	S.RES ERJ2GEJ-JPW	B	100.9/62
R216	7410001140	S.ARR EXB28V104JX	T	17.3/52.4
R217	7410001140	S.ARR EXB28V104JX	T	38.6/56
R218	7030005110	S.RES ERJ2GEJ 224 X (220K)	B	65/137.9
R220	7410001140	S.ARR EXB28V104JX	T	15.2/50.7
R222	7410001140	S.ARR EXB28V104JX	T	36.1/56
R223	7030005050	S.RES ERJ2GEJ 103 X (10K)	B	64/136.3
R224	7410001150	S.ARR EXB28V471JX	T	30.4/53.1
R225	7030005110	S.RES ERJ2GEJ 224 X (220K)	B	64/137.9
R226	7030005110	S.RES ERJ2GEJ 224 X (220K)	B	57.2/136.1
R227	7410001150	S.ARR EXB28V471JX	T	42.9/28.9
R230	7410001150	S.ARR EXB28V471JX	T	28.6/50.9
R231	7030005010	S.RES ERJ2GEJ 681 X (680) [USA-01]	B	55/138
	7030005010	S.RES ERJ2GEJ 681 X (680) [EXP-01]		
	7030005010	S.RES ERJ2GEJ 681 X (680) [USA-02]		
	7030005010	S.RES ERJ2GEJ 681 X (680) [EXP-02]		
	7030007280	S.RES ERJ2GEJ 331 X (330) [EUR-01]		
R232	7410001150	S.ARR EXB28V471JX	T	25.9/49.4
R233	7030005530	S.RES ERJ2GEJ 100 X (10)	B	54.1/136.1
R234	7410001150	S.ARR EXB28V471JX	T	42.5/25.7
R235	7410001150	S.ARR EXB28V471JX	T	24.2/47.6
R236	7030005090	S.RES ERJ2GEJ 104 X (100K)	B	133.1/82.8
R237	7030004970	S.RES ERJ2GEJ 470 X (47)	B	48.4/138.3
R238	7410001150	S.ARR EXB28V471JX	T	45.7/28.9
R239	7410001150	S.ARR EXB28V471JX	T	22.4/45.8
R240	7030004980	S.RES ERJ2GEJ 101 X (100)	B	135.8/84.5
R241	7030005710	S.RES ERJ2GEJ 121 X (120)	B	48.4/133.8
R242	7030009320	S.RES ERJ2GEJ 4R7 X (4.7)	B	47.4/138.3
R243	7030005090	S.RES ERJ2GEJ 104 X (100K)	B	46.4/138.3
R244	7410001150	S.ARR EXB28V471JX	T	39.7/25.8
R245	7410001150	S.ARR EXB28V471JX	T	20.2/42.4
R246	7030005240	S.RES ERJ2GEJ 473 X (47K)	B	44.4/136.1
R247	7030008290	S.RES ERJ2GEJ 183 X (18K)	B	47.4/140.4
R248	7030005600	S.RES ERJ2GEJ 273 X (27K)	B	137.4/85.8
R253	7030004970	S.RES ERJ2GEJ 470 X (47)	B	138.8/85.4
R255	7030008400	S.RES ERJ2GEJ 182 X (1.8K)	B	51.4/140.4
R257	7410001140	S.ARR EXB28V104JX	T	14.5/45.7
R258	7030005110	S.RES ERJ2GEJ 224 X (220K)	B	58.3/140.4
R259	7030005170	S.RES ERJ2GEJ 474 X (470K)	B	56.1/140.4
R260	7030005050	S.RES ERJ2GEJ 103 X (10K)	T	144.6/121.4
R261	7030005050	S.RES ERJ2GEJ 103 X (10K)	T	52.5/25.2
R262	7030005090	S.RES ERJ2GEJ 104 X (100K)	T	51.9/22.8
R263	7410001140	S.ARR EXB28V104JX	T	46.2/20
R264	7410001140	S.ARR EXB28V104JX	T	50.2/24
R265	7030007280	S.RES ERJ2GEJ 331 X (330)	T	143/121.4
R266	7030005090	S.RES ERJ2GEJ 104 X (100K)	B	34.6/133.5
R267	7410001140	S.ARR EXB28V104JX	T	14.8/43.1
R268	7410001150	S.ARR EXB28V471JX	T	45.7/31.8
R269	7030007270	S.RES ERJ2GEJ 151 X (150)	B	142.6/92.6
R270	7030005050	S.RES ERJ2GEJ 103 X (10K)	B	30.6/134
R271	7030005090	S.RES ERJ2GEJ 104 X (100K)	T	23.8/26.7
R272	7410001150	S.ARR EXB28V471JX	T	17.9/32.3
R273	7410001150	S.ARR EXB28V471JX	T	17.9/35.1
R274	7030005090	S.RES ERJ2GEJ 104 X (100K)	B	31.5/134

[MAIN UNIT]

REF NO.	ORDER NO.	DESCRIPTION	M.	H/V LOCATION
R277	7030004980	S.RES ERJ2GEJ 101 X (100)	T	143.4/126.6
R278	7030005090	S.RES ERJ2GEJ 104 X (100K)	T	13.9/85.6
R279	7030007290	S.RES ERJ2GEJ 222 X (2.2K)	T	103.6/68.4
R280	7030004990	S.RES ERJ2GEJ 221 X (220)	T	138.4/128.2
R281	7410001150	S.ARR EXB28V471JX	T	21.3/31.8
R282	7030005090	S.RES ERJ2GEJ 104 X (100K)	T	37.8/20.3
R283	7030005100	S.RES ERJ2GEJ 154 X (150K)	T	141.5/126.6
R285	7030005050	S.RES ERJ2GEJ 103 X (10K)	T	101.6/79.5
R287	7410001140	S.ARR EXB28V104JX	T	49.7/27.7
R288	7030005110	S.RES ERJ2GEJ 224 X (220K)	T	136.8/124.7
R289	7030006070	S.RES ERJ2YJ101U (100)	B	86.9/117.5
R290	7030005110	S.RES ERJ2GEJ 224 X (220K)	T	137.2/122.6
R291	7030005040	S.RES ERJ2GEJ 472 X (4.7K)	T	139.2/121.2
R292	7030005050	S.RES ERJ2GEJ 103 X (10K)	T	139.3/128.2
R295	7030006610	S.RES ERJ2GEJ 394 X (390K)	T	136.3/122.6
R296	7030007300	S.RES ERJ2GEJ 332 X (3.3K)	T	121.8/77.2
R297	7030007300	S.RES ERJ2GEJ 332 X (3.3K)	T	122.8/77.2
R298	7030000440	S.RES MCR10EZHJ 3.3K (332)	T	120.4/77.3
R299	7030004980	S.RES ERJ2GEJ 101 X (100)	B	29.1/19.4
R300	7030005530	S.RES ERJ2GEJ 100 X (10)	T	47.6/73.1
R301	7030008300	S.RES ERJ2GEJ 184 X (180K)	B	85.7/131
R303	7410001150	S.ARR EXB28V471JX	T	47.7/68.4
R304	7030005050	S.RES ERJ2GEJ 103 X (10K)	B	95.4/135.9
R306	7520000260	S.POS PRF18BB471QB1RB	B	87.3/130.2
R308	7030008010	S.RES ERJ2GEJ 123 X (12K) [USA-01]	T	140.7/128.3
	7030008010	S.RES ERJ2GEJ 123 X (12K) [EXP-01]		
	7030008010	S.RES ERJ2GEJ 123 X (12K) [USA-02]		
	7030008010	S.RES ERJ2GEJ 123 X (12K) [EXP-02]		
	7030007340	S.RES ERJ2GEJ 153 X (15K) [EUR-01]		
R309	7030005040	S.RES ERJ2GEJ 472 X (4.7K)	T	102.2/75.7
R313	7030005050	S.RES ERJ2GEJ 103 X (10K)	T	103.5/77.3
R315	7030005700	S.RES ERJ2GEJ 274 X (270K)	B	98.6/137.8
R316	7030005050	S.RES ERJ2GEJ 103 X (10K)	T	11.2/128.2
R320	7030005090	S.RES ERJ2GEJ 104 X (100K)	B	15/124.1
R321	7030003320	S.RES ERJ3GEYJ 101 V (100)	B	119.5/142.1
R322	7030007350	S.RES ERJ2GEJ 393 X (39K)	B	119.4/144.2
R324	7030005050	S.RES ERJ2GEJ 103 X (10K)	B	31.3/12
R325	7030005120	S.RES ERJ2GEJ 102 X (1K)	B	32.3/12
R326	7030005240	S.RES ERJ2GEJ 473 X (47K)	T	13.2/125.7
R327	7030000220	S.RES MCR10EZHJ 47 (470)	B	119.7/132.8
R328	7030000260	S.RES MCR10EZHJ 100 (101)	B	139.3/144.3
R331	7030004980	S.RES ERJ2GEJ 101 X (100)	T	12/120
R332	7030003320	S.RES ERJ3GEYJ 101 V (100)	B	139.5/135
R333	7030007350	S.RES ERJ2GEJ 393 X (39K)	B	139.3/131.4
R334	7030005651	S.RES ERA3YKD 304V (300K)	T	57.8/30.5
R335	7030005871	S.RES ERA3YKD 104V (100K)	T	55.9/28.7
R336	7030005110	S.RES ERJ2GEJ 224 X (220K)	T	12/120.9
R337	7030005110	S.RES ERJ2GEJ 224 X (220K)	T	13.2/120.6
R339	7030005090	S.RES ERJ2GEJ 104 X (100K)	T	12/125.3
R341	7030005050	S.RES ERJ2GEJ 103 X (10K)	B	33.3/12
R342	7030005090	S.RES ERJ2GEJ 104 X (100K)	B	45.3/56.9
R346	7410001150	S.ARR EXB28V471JX	T	43.5/73.8
R347	7030005000	S.RES ERJ2GEJ 471 X (470)	T	9.8/132.9
R348	7030000620	S.RES MCR10EZHJ 100 K (104)	B	147.2/150.9
R349	7030000620	S.RES MCR10EZHJ 100 K (104)	B	26/149.7
R350	7030003560	S.RES ERJ3GEYJ 103 V (10K)	B	6.4/131
R352	7030005040	S.RES ERJ2GEJ 472 X (4.7K)	T	10.2/125.3
R353	7030005240	S.RES ERJ2GEJ 473 X (47K)	B	55.8/56.9
R354	7030005700	S.RES ERJ2GEJ 274 X (270K)	T	125.2/103.6
R355	7030005090	S.RES ERJ2GEJ 104 X (100K)	T	129.2/103.6
R356	7030005050	S.RES ERJ2GEJ 103 X (10K)	T	9.8/134.5
R357	7030003560	S.RES ERJ3GEYJ 103 V (10K)	B	10.1/150.2
R362	7540000290	ABS ERZV10D220		
R364	7030005110	S.RES ERJ2GEJ 224 X (220K)	T	65.1/71.2
R365	7030005050	S.RES ERJ2GEJ 103 X (10K)	T	7.4/120.7
R366	7030007290	S.RES ERJ2GEJ 222 X (2.2K)	T	7/123.5
R367	7030004980	S.RES ERJ2GEJ 101 X (100)	T	9.7/117.3
R368	7030008300	S.RES ERJ2GEJ 184 X (180K)	T	8.5/117.8
R369	7030005230	S.RES ERJ2GEJ 334 X (330K)	T	9.7/118.2
R370	7030008280	S.RES ERJ2GEJ 271 X (270)	T	6.1/120.7
R371	7030010040	S.RES ERJ2GEJ-JPW	T	5/117.3
R372	7030005000	S.RES ERJ2GEJ 471 X (470)	T	115.3/15.8
R373	7030005050	S.RES ERJ2GEJ 103 X (10K)	T	115.3/14
R374	7030000140	S.RES MCR10EZHJ 10 (100)	T	111.2/12.3
R375	7030010040	S.RES ERJ2GEJ-JPW	T	100.1/16.3
R376	7030004980	S.RES ERJ2GEJ 101 X (100)	B	62.3/122.2
R377	7030005000	S.RES ERJ2GEJ 101 X (470)	B	62.3/124.7
R378	7030005210	S.RES ERJ2GEJ 822 X (8.2K)	B	63.2/126.1
R379	7030005210	S.RES ERJ2GEJ		

[MAIN UNIT]

REF NO.	ORDER NO.	DESCRIPTION	M.	H/V LOCATION
R448	7030005090	S.RES ERJ2GEJ 104 X (100K)	T	49.3/19.2
R449	7030005170	S.RES ERJ2GEJ 474 X (470K)	T	39.5/19.2
R450	7030005050	S.RES ERJ2GEJ 103 X (10K)	T	50.2/16.5
R453	7030005120	S.RES ERJ2GEJ 102 X (1K)	T	52/13.9
R454	7030005120	S.RES ERJ2GEJ 102 X (1K)	B	94.9/2.7
R455	7030005010	S.RES ERJ2GEJ 681 X (680)	B	124.9/2.7
R456	7030005120	S.RES ERJ2GEJ 102 X (1K)	B	109.9/2.7
R467	7030005240	S.RES ERJ2GEJ 473 X (47K)	B	38/44.6
R468	7410001140	S.ARR EXB28V104JX	B	31.8/48.5
R469	7030005090	S.RES ERJ2GEJ 104 X (100K)	B	32.6/44.6
R470	7030005090	S.RES ERJ2GEJ 104 X (100K)	T	10.9/20.2
R471	7030005090	S.RES ERJ2GEJ 104 X (100K)	B	47.7/44.2
R472	7030005240	S.RES ERJ2GEJ 473 X (47K)	B	4.7/36.1
R473	7030005090	S.RES ERJ2GEJ 104 X (100K)	B	46.2/44.6
R474	7030005530	S.RES ERJ2GEJ 100 X (10)	B	15.5/55.3
R475	7030005240	S.RES ERJ2GEJ 473 X (47K)	B	9/56.2
R476	7030005090	S.RES ERJ2GEJ 104 X (100K)	B	15/53.5
R477	7030005080	S.RES ERJ2GEJ 823 X (82K)	B	15/52.6
R478	7030005050	S.RES ERJ2GEJ 103 X (10K)	B	9.1/54.7
R479	7030005110	S.RES ERJ2GEJ 224 X (220K)	T	64.2/69.6
R480	7030005050	S.RES ERJ2GEJ 103 X (10K)	B	15.6/61.5
R481	7030005050	S.RES ERJ2GEJ 103 X (10K)	B	16.5/59.9
R482	7410001150	S.ARR EXB28V471JX	T	19.6/45.1
R483	7030005090	S.RES ERJ2GEJ 104 X (100K)	T	31.2/56.5
R484	7030005090	S.RES ERJ2GEJ 104 X (100K)	B	28.8/50.9
R485	7410001150	S.ARR EXB28V471JX	T	67.3/96.9
R486	7410001150	S.ARR EXB28V471JX	T	64.8/105.4
R487	7410001150	S.ARR EXB28V471JX	T	72.8/105.4
R488	7030008400	S.RES ERJ2GEJ 182 X (1.8K)	T	9.5/54.9
R489	7030004980	S.RES ERJ2GEJ 101 X (100)	B	24.1/58.7
R490	7030008290	S.RES ERJ2GEJ 183 X (18K)	B	28.2/58.4
R491	7030004980	S.RES ERJ2GEJ 101 X (100)	B	26.1/51.2
R492	7030005240	S.RES ERJ2GEJ 473 X (47K)	B	29.8/58.8
R493	7030010040	S.RES ERJ2GEJ-JPW	T	11.3/19
R494	7030005000	S.RES ERJ2GEJ 471 X (470)	T	73.2/98.2
R495	7030005100	S.RES ERJ2GEJ 154 X (150K)	T	55.2/55.3
R496	7030005070	S.RES ERJ2GEJ 683 X (68K)	T	52.7/56.2
R497	7030005700	S.RES ERJ2GEJ 274 X (270K)	T	52.7/55.3
R498	7030005600	S.RES ERJ2GEJ 273 X (27K)	B	61.4/103.1
R499	7030004980	S.RES ERJ2GEJ 101 X (100)	T	24.4/57
R500	7030005600	S.RES ERJ2GEJ 273 X (27K)	T	21.2/57.5
R501	7030005220	S.RES ERJ2GEJ 223 X (22K)	T	22.8/53.8
R502	7030005090	S.RES ERJ2GEJ 104 X (100K)	T	28/55
R503	7030007350	S.RES ERJ2GEJ 393 X (39K)	T	55.5/58.4
R505	7030010040	S.RES ERJ2GEJ-JPW	T	113.4/18.3
R506	7030005110	S.RES ERJ2GEJ 224 X (220K)	T	113.4/19.3
R507	7030005090	S.RES ERJ2GEJ 104 X (100K)	T	115/19.3
R508	7030010040	S.RES ERJ2GEJ-JPW	T	144.6/119.6
R509	7030005050	S.RES ERJ2GEJ 103 X (10K)	B	33.3/15.2
R510	7030007350	S.RES ERJ2GEJ 393 X (39K)	B	29/14.1
R511	7030005050	S.RES ERJ2GEJ 103 X (10K)	B	29.1/18.5
R512	7030005050	S.RES ERJ2GEJ 103 X (10K)	B	30.8/18.5
R513	7030007280	S.RES ERJ2GEJ 331 X (330)	B	72.3/90.4
R530	7030005240	S.RES ERJ2GEJ 473 X (47K)	T	62.5/66.3
R531	7030007290	S.RES ERJ2GEJ 222 X (2.2K)	B	64.6/78.2
R532	7030005000	S.RES ERJ2GEJ 471 X (470)	B	45.1/37.1
R533	7030005090	S.RES ERJ2GEJ 104 X (100K)	T	57.2/18.4
R534	7030005600	S.RES ERJ2GEJ 273 X (27K)	B	45.3/58.6
R535	7030004980	S.RES ERJ2GEJ 101 X (100)	B	55.8/55.3
R536	7030005600	S.RES ERJ2GEJ 273 X (27K)	B	55.8/58.6
R537	7030010040	S.RES ERJ2GEJ-JPW	B	41.6/41.2
R539	7030005100	S.RES ERJ2GEJ 154 X (150K)	T	64.2/71.2
R540	7030005090	S.RES ERJ2GEJ 104 X (100K)	T	90.6/17.9
R541	7030005220	S.RES ERJ2GEJ 223 X (22K)	T	28.9/55
R542	7030005110	S.RES ERJ2GEJ 224 X (220K)	B	39.9/72.7
R543	7030005080	S.RES ERJ2GEJ 823 X (82K)	B	40.8/71.1
C1	4030017420	S.CER ECJ0EC1H470J	B	120.7/39
C2	4030017420	S.CER ECJ0EC1H470J	B	22.9/78.1
C3	4030016930	S.CER ECJ0EB1A104K	B	130.8/50.2
C4	4030017420	S.CER ECJ0EC1H470J	B	122.2/37.1
C5	4030017420	S.CER ECJ0EC1H470J	B	21.7/77.1
C6	4030016930	S.CER ECJ0EB1A104K	B	52.4/77.9
C7	4030017420	S.CER ECJ0EC1H470J	B	123.1/37.1
C8	4030017420	S.CER ECJ0EC1H470J	B	21.7/75.5
C9	4030017460	S.CER ECJ0EB1E102K	T	17.6/59
C10	4030016930	S.CER ECJ0EB1A104K	B	55.7/77.9
C11	4030016930	S.CER ECJ0EB1A104K	B	124/37.1
C12	4030016930	S.CER ECJ0EB1A104K	B	22.1/74.3
C13	4030016930	S.CER ECJ0EB1A104K	B	55.6/80.7
C14	4030017460	S.CER ECJ0EB1E102K	T	16.1/59.9
C15	4030016930	S.CER ECJ0EB1A104K	T	62.4/67.5
C16	4030017420	S.CER ECJ0EC1H470J	T	56.2/64.5
C17	4030016930	S.CER ECJ0EB1A104K	B	115.6/40.6
C18	4030017700	S.CER ECJ0EC1H151J	T	62.4/71.2
C19	4030016930	S.CER ECJ0EB1A104K	B	22.9/80.3
C20	4550006250	S.TAN TEESVA 1A 106M8R	B	115.4/37.5
C21	4550006250	S.TAN TEESVA 1A 106M8R	B	21.3/80.5
C22	4030016930	S.CER ECJ0EB1A104K	B	50/77.9
C23	4030016930	S.CER ECJ0EB1A104K	T	57.8/52.6
C24	4030016930	S.CER ECJ0EB1A104K	B	50.3/81.1
C25	4030016930	S.CER ECJ0EB1A104K	B	54.4/81.1
C26	4030017460	S.CER ECJ0EB1E102K	B	117.8/39.2
C27	4030017460	S.CER ECJ0EB1E102K	B	23.8/80.3
C28	4030016930	S.CER ECJ0EB1A104K	B	53.3/77.9
C30	4030017460	S.CER ECJ0EB1E102K	B	59.8/67
C31	4030016930	S.CER ECJ0EB1A104K	T	60.5/53
C32	4030017590	S.CER ECJ0EC1H070C	B	38.4/79.1
C33	4030016930	S.CER ECJ0EB1A104K	T	58.9/67
C34	4030017570	S.CER ECJ0EC1H040B	B	37.2/78.7
C35	4030016930	S.CER ECJ0EB1A104K	B	38.3/76
C36	4030017500	S.CER ECJ0EC1H560J	B	37.2/79.6
C37	4030016930	S.CER ECJ0EB1A104K	B	48.4/79.8

[MAIN UNIT]

REF NO.	ORDER NO.	DESCRIPTION	M.	H/V LOCATION
C38	4030016930	S.CER ECJ0EB1A104K	B	69.8/78.2
C39	4030017360	S.CER ECJ0EC1H030B	B	71.4/77.3
C40	4030017760	S.CER ECJ0EB1H222K	B	68.2/77.3
C41	4030018860	S.CER ECJ0EB0J105K	B	31/58.2
C42	4030017760	S.CER ECJ0EB1H222K	B	68.2/76.4
C43	4030016930	S.CER ECJ0EB1A104K	B	55.6/49
C44	4030018860	S.CER ECJ0EB0J105K	B	35.7/56.4
C45	4030016950	S.CER ECJ0EB1A473K	B	34.5/55.2
C47	4030017460	S.CER ECJ0EB1E102K	B	64.6/77.3
C48	4030016930	S.CER ECJ0EB1A104K	T	52.7/54.4
C49	4030018860	S.CER ECJ0EB0J105K	B	15.6/58.3
C50	4030016930	S.CER ECJ0EB1A104K	B	130.8/48.4
C51	4030017620	S.CER ECJ0EC1H100C	B	125.1/45.3
C52	4030017420	S.CER ECJ0EC1H470J	B	120.6/48.8
C53	4030017420	S.CER ECJ0EC1H470J	B	32.7/78.4
C54	4030017660	S.CER ECJ0EC1H330J	B	32.7/77.3
C56	4030016950	S.CER ECJ0EB1A473K	B	31.9/59.1
C59	4030017430	S.CER ECJ0EC1H101J	B	32.7/76.4
C60	4030017620	S.CER ECJ0EC1H100C	B	32.3/72.9
C61	4030018900	S.CER ECJ0EB0J474K	B	18/63.8
C62	4030016930	S.CER ECJ0EB1A104K	B	33.6/55.2
C63	4030016930	S.CER ECJ0EB1A104K	T	55.5/61.6
C66	4030017430	S.CER ECJ0EC1H101J	B	123.5/48.4
C67	4030017460	S.CER ECJ0EB1E102K	B	67.5/87.7
C69	4030016930	S.CER ECJ0EB1A104K	B	29.8/63
C70	4030017460	S.CER ECJ0EB1E102K	B	64.3/79.4
C71	4030016930	S.CER ECJ0EB1A104K	B	57.6/43.3
C72	4030018910	S.CER C1608 JB 0J 475K-T	B	29.3/61.9
C73	4030017460	S.CER ECJ0EB1E102K	B	96.3/45.4
C75	4030017460	S.CER ECJ0EB1E102K	B	36/105.6
C77	4030016930	S.CER ECJ0EB1A104K	T	53.9/57.7
C78	4030017460	S.CER ECJ0EB1E102K	B	119.7/50.4
C79	4030017460	S.CER ECJ0EB1E102K	B	34.3/79.5
C80	4030017350	S.CER ECJ0EC1H020B	[USA-01] [EXP-01]	B 102.4/45.6
	4030017350	S.CER ECJ0EC1H020B	[USA-02]	
	4030017550	S.CER ECJ0EC1H1R5B	[USA-02]	
	4030017550	S.CER ECJ0EC1H1R5B	[EXP-02]	
	4030017350	S.CER ECJ0EC1H020B	[EUR-01]	
C81	4030017350	S.CER ECJ0EC1H020B	[USA-01]	B 42.2/99.6
	4030017350	S.CER ECJ0EC1H020B	[EXP-01]	
	4030017550	S.CER ECJ0EC1H1R5B	[USA-02]	
	4030017550	S.CER ECJ0EC1H1R5B	[EXP-02]	
	4030017350	S.CER ECJ0EC1H020B	[EUR-01]	
C82	4550006250	S.TAN TEESVA 1A 106M8R	B	61.1/79.2
C83	4030017460	S.CER ECJ0EB1E102K	B	71.7/86.7
C84	4030017420	S.CER ECJ0EC1H470J	B	74.7/81.1
C85	4030017590	S.CER ECJ0EC1H070C	B	56/43.3
C86	4030016930	S.CER ECJ0EB1A104K	B	51.7/47.1
C87	4030018910	S.CER C1608 JB 0J 475K-T	B	54.3/48.4
C88	4030017770	S.CER ECJ0EB1E332K	B	86.7/40.6
C89	4030017770	S.CER ECJ0EB1E332K	B	28/99.3
C90	4030017680	S.CER ECJ0EC1H820J	B	69.1/86.7
C91	4030016930	S.CER ECJ0EB1A104K	T	60.7/66.3
C92	4030016930	S.CER ECJ0EB1C103K	B	72.7/88
C93	4030017460	S.CER ECJ0EB1E102K	B	70/87.9
C96	4030018910	S.CER C1608 JB 0J 475K-T	B	49.2/48.9
C97	4030016930	S.CER ECJ0EB1A104K	B	57.4/50.6
C98	4030017460	S.CER ECJ0EB1E102K	B	35.1/107.3
C99	4030017460	S.CER ECJ0EB1E102K	B	40.8/72.7
C101	4030017620	S.CER ECJ0EC1H100C	B	37.7/63.2
C102	4550000560	S.TAN TEESVA 1V 334M8R	B	84.7/42.7
C103	4550003260	S.TAN TEESVA 1V 684M8R	B	26.2/100.4
C104	4030016930	S.CER ECJ0EB1A104K	B	39.9/74.5
C105	4030017520	S.CER ECJ0EC1HOR3B	B	103.2/47.8
C106	4030017340	S.CER ECJ0EC1H010B	B	47/100.1
C107	4030017590	S.CER ECJ0EC1H070C	B	72.3/89.5
C108	4030017460	S.CER ECJ0EB1E102K	B	94.5/47.1
C109	4030017530	S.CER ECJ0EC1HOR5B	B	101.9/48.3
C110	4030017530	S.CER ECJ0EC1HOR5B	B	46.5/101.4
C111	4030016790	S.CER ECJ0EB1C103K	B	70.7/92.3
C112	4550000270	S.TAN TEESVA 1E 474M8R	B	84.7/47.9
C113	4550000270	S.TAN TEESVA 1E 474M8R	B	26.2/105.6
C114	4030017520	S.CER ECJ0EC1HOR3B	B	103.2/49.6
C115	4030017550	S.CER ECJ0EC1H1R5B	[USA-01] [EXP-01]	B 47/102.8
	4030017550	S.CER ECJ0EC1H1R5B	[USA-02]	
	4030017340	S.CER ECJ0EC1H010B	[EXP-02]	
	4030017340	S.CER ECJ0EC1H010B	[EUR-01]	
C116	4030017460	S.CER ECJ0EB1E102K	B	70.7/89.5
C117	4030016790	S.CER ECJ0EB1C103K	B	69.1/90.4
C118	4030016790	S.CER ECJ0EB1C103K	B	69.1/91.3
C121	4030016790	S.CER ECJ0EB1C103K	B	71.1/94.8
C122	4030016790	S.CER ECJ0EB1C103K	B	67.2/91.6
C123	4030016930	S.CER ECJ0EB1A104K	B	67.5/100.1
C124	4030016930	S.CER ECJ0EB1A104K	B	48.5/50.5
C125	4030016790	S.CER ECJ0EB1C103K	B	95.4/43.7
C126	4030016790	S.CER ECJ0EB1C103K	B	57.2/35.1
C127	4030016790	S.CER ECJ0EB1C103K	B	36/103.9



[MAIN UNIT]

REF NO.	ORDER NO.	DESCRIPTION	M.	H/V LOCATION
C152	4030016930	S.CER ECJ0EB1A104K	B	55.3/32.4
C153	4030017380	S.CER ECJ0EC1H050B	B	49.8/34.9
C154	4030017420	S.CER ECJ0EC1H470J	B	26.5/120.6
C155	4030017460	S.CER ECJ0EB1E102K	B	26.5/123.2
C156	4030017420	S.CER ECJ0EC1H470J	B	28.5/111.5
C157	4030017460	S.CER ECJ0EB1E102K	B	28/117.2
C158	4030017420	S.CER ECJ0EC1H470J	B	81.7/62.1
C159	4030017420	S.CER ECJ0EB1A104K	B	81.7/53.6
C160	4030016790	S.CER ECJ0EB1C103K	B	65.7/104.4
C161	4030016790	S.CER ECJ0EB1C103K	B	62.7/98.9
C162	4030016930	S.CER ECJ0EB1A104K	B	81.7/67.1
C163	4030016930	S.CER ECJ0EB1A104K	B	81.7/58.6
C164	4030016930	S.CER ECJ0EB1A104K	B	49.5/36.8
C165	4030017460	S.CER ECJ0EB1E102K	B	81.7/66.2
C166	4030017460	S.CER ECJ0EB1E102K	B	81.7/57.7
C167	4030017460	S.CER ECJ0EB1E102K	B	97.3/45.4
C168	4030017380	S.CER ECJ0EC1H050B	B	32.6/124.3
C169	4030017620	S.CER ECJ0EC1H100C [USA-01]	B	30.8/124.4
	4030017620	S.CER ECJ0EC1H100C [EXP-01]		
	4030017570	S.CER ECJ0EC1H040B [USA-02]		
	4030017570	S.CER ECJ0EC1H040B [EXP-02]		
	4030017620	S.CER ECJ0EC1H100C [EUR-01]		
C170	4030017580	S.CER ECJ0EC1H060C	B	30.6/114.4
C171	4030017630	S.CER ECJ0EC1H120J [USA-01]	B	30.6/115.3
	4030017630	S.CER ECJ0EC1H120J [EXP-01]		
	4030017380	S.CER ECJ0EC1H050B [USA-02]		
	4030017380	S.CER ECJ0EC1H050B [EXP-02]		
	4030017630	S.CER ECJ0EC1H120J [EUR-01]		
C172	4030017580	S.CER ECJ0EC1H060C [USA-01]	B	87.8/65.7
	4030017580	S.CER ECJ0EC1H060C [EXP-01]		
	4030017570	S.CER ECJ0EC1H040B [USA-02]		
	4030017570	S.CER ECJ0EC1H040B [EXP-02]		
	4030017580	S.CER ECJ0EC1H060C [EUR-01]		
C173	4030017630	S.CER ECJ0EC1H120J [USA-01]	B	86.5/65.3
	4030017630	S.CER ECJ0EC1H120J [EXP-01]		
	4030017620	S.CER ECJ0EC1H100C [USA-02]		
	4030017620	S.CER ECJ0EC1H100C [EXP-02]		
	4030017630	S.CER ECJ0EC1H120J [EUR-01]		
C174	4030017590	S.CER ECJ0EC1H070C [USA-01]	B	85.7/55
	4030017590	S.CER ECJ0EC1H070C [EXP-01]		
	4030017580	S.CER ECJ0EC1H060C [USA-02]		
	4030017580	S.CER ECJ0EC1H060C [EXP-02]		
	4030017590	S.CER ECJ0EC1H070C [EUR-01]		
C175	4030017390	S.CER ECJ0EC1H180J [USA-01]	B	85.7/55.9
	4030017390	S.CER ECJ0EC1H180J [EXP-01]		
	4030017590	S.CER ECJ0EC1H070C [USA-02]		
	4030017590	S.CER ECJ0EC1H070C [EXP-02]		
	4030017390	S.CER ECJ0EC1H180J [EUR-01]		
C176	4030018860	S.CER ECJ0EB0J105K	T	62.9/51
C177	4030017380	S.CER ECJ0EC1H050B [USA-01]	B	35.6/120.7
	4030017380	S.CER ECJ0EC1H050B [EXP-01]		
	4030017350	S.CER ECJ0EC1H020B [USA-02]		
	4030017350	S.CER ECJ0EC1H020B [EXP-02]		
	4030017380	S.CER ECJ0EC1H050B [EUR-01]		
C178	4030017580	S.CER ECJ0EC1H060C [USA-01]	B	32/112.2
	4030017580	S.CER ECJ0EC1H060C [EXP-01]		
	4030017360	S.CER ECJ0EC1H030B [USA-02]		
	4030017360	S.CER ECJ0EC1H030B [EXP-02]		
	4030017580	S.CER ECJ0EC1H060C [EUR-01]		
C179	4030017420	S.CER ECJ0EC1H470J	T	14.9/129.1
C180	4030017600	S.CER ECJ0EC1H080C [USA-01]	B	91.5/62
	4030017600	S.CER ECJ0EC1H080C [EXP-01]		
	4030017570	S.CER ECJ0EC1H040B [USA-02]		
	4030017570	S.CER ECJ0EC1H040B [EXP-02]		
	4030017600	S.CER ECJ0EC1H080C [EUR-01]		
C181	4030017590	S.CER ECJ0EC1H070C [USA-01]	B	87.1/52.9
	4030017590	S.CER ECJ0EC1H070C [EXP-01]		
	4030017380	S.CER ECJ0EC1H050B [USA-02]		
	4030017380	S.CER ECJ0EC1H050B [EXP-02]		
	4030017590	S.CER ECJ0EC1H070C [EUR-01]		
C182	4030016790	S.CER ECJ0EB1C103K	B	63.1/104.4
C183	4030017420	S.CER ECJ0EC1H470J	T	14.9/131.3
C184	4030017620	S.CER ECJ0EC1H100C	B	34.9/124.3
C185	4030017630	S.CER ECJ0EC1H120J [USA-01]	B	35.4/115.3
	4030017630	S.CER ECJ0EC1H120J [EXP-01]		
	4030017610	S.CER ECJ0EC1H090C [USA-02]		
	4030017610	S.CER ECJ0EC1H090C [EXP-02]		
	4030017630	S.CER ECJ0EC1H120J [EUR-01]		
C186	4030017420	S.CER ECJ0EC1H470J	B	98.2/48.8
C187	4030017540	S.CER ECJ0EC1HR75B [USA-01]	B	89.4/66.8
	4030017540	S.CER ECJ0EC1HR75B [EXP-01]		
	4030017530	S.CER ECJ0EC1H0R5B [USA-02]		
	4030017530	S.CER ECJ0EC1H0R5B [EXP-02]		
	4030017540	S.CER ECJ0EC1HR75B [EUR-01]		
C188	4030017360	S.CER ECJ0EC1H030B	B	90.6/66.6
C189	4030017340	S.CER ECJ0EC1H010B	B	87/57.2
C190	4030017350	S.CER ECJ0EC1H020B [USA-01]	B	87/58.2
	4030017350	S.CER ECJ0EC1H020B [EXP-01]		
	4030017340	S.CER ECJ0EC1H010B [USA-02]		
	4030017340	S.CER ECJ0EC1H010B [EXP-02]		
	4030017350	S.CER ECJ0EC1H020B [EUR-01]		
C191	4030017380	S.CER ECJ0EC1H050B [USA-01]	B	89.4/65.7
	4030017380	S.CER ECJ0EC1H050B [EXP-01]		
	4030017640	S.CER ECJ0EC1H150J [USA-02]		
	4030017640	S.CER ECJ0EC1H150J [EXP-02]		
	4030017380	S.CER ECJ0EC1H050B [EUR-01]		
C192	4030017640	S.CER ECJ0EC1H150J [USA-01]	B	90.5/56.3
	4030017640	S.CER ECJ0EC1H150J [EXP-01]		
	4030017600	S.CER ECJ0EC1H080C [USA-02]		
	4030017600	S.CER ECJ0EC1H080C [EXP-02]		
	4030017640	S.CER ECJ0EC1H150J [EUR-01]		
C193	4030017460	S.CER ECJ0EB1E102K	B	61.4/107.1
C194	4030017580	S.CER ECJ0EC1H060C [USA-01]	B	36.8/122.8

[MAIN UNIT]

REF NO.	ORDER NO.	DESCRIPTION	M.	H/V LOCATION
C194	4030017580	S.CER ECJ0EC1H060C [EXP-01]		
	4030017600	S.CER ECJ0EC1H080C [USA-02]		
	4030017600	S.CER ECJ0EC1H080C [EXP-02]		
	4030017580	S.CER ECJ0EC1H060C [EUR-01]		
C195	4030017630	S.CER ECJ0EC1H120J	B	40.1/120.7
C196	4030017620	S.CER ECJ0EC1H100C	B	37.6/114.4
C197	4030017640	S.CER ECJ0EC1H150J	B	41/112.2
C198	4030016790	S.CER ECJ0EB1C103K	B	60.5/107.1
C200	4030017570	S.CER ECJ0EC1H040B	B	92.4/64.3
C201	4030017620	S.CER ECJ0EC1H100C	B	96/62
C202	4030017610	S.CER ECJ0EC1H090C	B	93.1/55.4
C203	4030017390	S.CER ECJ0EC1H180J	B	96.3/52.9
C204	4550006250	S.TAN TEESVA 1A 106M8R	T	81.7/17
C205	4550006250	S.TAN TEESVA 1A 106M8R	T	85.1/17
C206	4550006250	S.TAN TEESVA 1A 106M8R	T	88.8/16.7
C208	4030017490	S.CER C1608 JB 1A 105K-T	T	80/16.6
C209	4030017490	S.CER C1608 JB 1A 105K-T	T	83.4/16.6
C210	4030017490	S.CER C1608 JB 1A 105K-T	T	86.9/16.3
C211	4030016930	S.CER ECJ0EB1A104K	B	38.3/120.7
C212	4030016790	S.CER ECJ0EB1C103K	B	39.2/112.2
C213	4030017660	S.CER ECJ0EC1H330J	B	68.5/106.1
C214	4030017460	S.CER ECJ0EB1E102K	B	66.8/107
C215	4030017530	S.CER ECJ0EC1H0R5B	B	41.9/120.7
C216	4030017520	S.CER ECJ0EC1H0R3B	B	42.6/115.7
C217	4030017460	S.CER ECJ0EB1E102K	B	39.2/120.7
C218	4030017460	S.CER ECJ0EB1E102K	B	40.1/112.2
C219	4030016790	S.CER ECJ0EB1C103K	B	94.2/62
C220	4030017530	S.CER ECJ0EC1H0R5B	B	98.2/61.3
C221	4030016790	S.CER ECJ0EB1C103K	B	94.5/52.9
C222	4030017530	S.CER ECJ0EC1H0R5B	B	98.2/57.1
C224	4030017460	S.CER ECJ0EB1E102K	B	95.1/62
C225	4030017460	S.CER ECJ0EB1E102K	B	95.4/52.9
C228	4030017490	S.CER C1608 JB 1A 105K-T	T	79.8/24.4
C229	4030017490	S.CER C1608 JB 1A 105K-T	T	83.3/24.4
C230	4030017490	S.CER C1608 JB 1A 105K-T	T	86.8/24.4
C231	4550005980	S.TAN TEESVA 1A 475M8R	T	81.6/25.6
C232	4550005980	S.TAN TEESVA 1A 475M8R	T	85.1/25.6
C233	4550005980	S.TAN TEESVA 1A 475M8R	T	88.5/25.6
C235	4030017030	S.CER ECJ0EB1A273K	T	41/55
C236	4030017730	S.CER ECJ0EB1E471K	B	100.5/55
C237	4030017460	S.CER ECJ0EB1E102K	B	100.5/60.4
C238	4030017730	S.CER ECJ0EB1E471K	B	44.9/112.6
C239	4030017460	S.CER ECJ0EB1E102K	B	44.9/118
C240	4510008540	S.LEE EEE1CA100SR	T	95.1/22.3
C241	4030017350	S.CER ECJ0EC1H020B	B	68.3/120.9
C242	4030016790	S.CER ECJ0EB1C103K	B	68.7/111.2
C243	4030017460	S.CER ECJ0EB1E102K	B	70.3/106.1
C244	4030016790	S.CER ECJ0EB1C103K	B	70.3/107
C245	4030017460	S.CER ECJ0EB1E102K	B	91.5/59.6
C246	4030017580	S.CER ECJ0EC1H060C	B	46.9/113.5
C247	4030017460	S.CER ECJ0EB1E102K	B	43.1/109.1
C248	4030017460	S.CER ECJ0EB1E102K	B	36/117.8
C249	4030017420	S.CER ECJ0EC1H470J	B	48.1/109.1
C250	4030017380	S.CER ECJ0EC1H050B	B	103.7/58.7
C251	4030017580	S.CER ECJ0EC1H060C [USA-01]	B	102.6/55.9
	4030017580	S.CER ECJ0EC1H060C [EXP-01]		
	4030017600	S.CER ECJ0EC1H080C [USA-02]		
	4030017600	S.CER ECJ0EC1H080C [EXP-02]		
	4030017580	S.CER ECJ0EC1H060C [EUR-01]		
C252	4030017460	S.CER ECJ0EB1E102K	B	100.5/50
C253	4030017380	S.CER ECJ0EC1H050B	B	48/116.2
C254	4030017460	S.CER ECJ0EB1E102K	B	103.7/53.4
C255	4030016930	S.CER ECJ0EB1A104K	T	42.1/50.6
C256	4030017640	S.CER ECJ0EC1H150J	T	43.1/55
C257	4030016790	S.CER ECJ0EB1C103K	T	34.5/58.8
C258	4030017580	S.CER ECJ0EC1H060C [USA-01]	B	59.6/117.8
	4030017580	S.CER ECJ0EC1H060C [EXP-01]		
	4030017620	S.CER ECJ0EC1H100C [USA-02]		
	4030017620	S.CER ECJ0EC1H100C [EXP-02]		
	4030017580	S.CER ECJ0EC1H060C [EUR-01]		
C259	4030017580	S.CER ECJ0EC1H060C	T	48.5/46.4
C260	4030017460	S.CER ECJ0EB1E102K	B	46.5/105.4
C262	4030016930	S.CER ECJ0EB1A104K	T	69.2/57.5
C263	4030017420	S.CER ECJ0EC1H470J	B	60.5/126.1
C264	4030017460	S.CER ECJ0EB1E102K	B	101.9/50
C265	4030017460	S.CER ECJ0EB1E102K	B	43.5/120.7
C266	4030018900	S.CER ECJ0EB0J474K	T	43.9/45.6
C267	4030017630	S.CER ECJ0EC1H120J [USA-01]	B	59.6/119.3
	4030017630	S.CER ECJ0EC1H120J [EXP-01]		
	4030017390	S.CER ECJ0EC1H180J [USA-02]		
	4030017390	S.CER ECJ0EC1H180J [EXP-02]		
	4030017630	S.CER ECJ0EC1H120J [EUR-01]		
C268	4030017420	S.CER ECJ0EC1H470J	B	62.3/126.1
C269	4550006780	S.TAN TEESVB2 0J 476M8R	T	71.8/60.8
C270	4030016930	S.CER ECJ0EB1A104K	T	40.5/49.7
C271	4030017350	S.CER ECJ0EC1H020B	B	68.1/137.9
C272	4030017630	S.CER ECJ0EC1H120J	T	47.3/60.1
C274	4030017460	S.CER ECJ0EB1E102K	B	44.4/120.7
C275	4030017620	S.CER ECJ0EC1H100C [USA-01]	B	48/124.4
	4030017620	S.CER ECJ0EC1H100C [EXP-01]		
	4030017580	S.CER ECJ0EC1H060C [USA-02]		
	4030017580	S.CER ECJ0EC1H060C [EXP-02]		
	4030017620	S.CER ECJ0EC1H100C [EUR-01]		
C276	4030017530	S.CER ECJ0EC1H0R5B [USA-01]	B	67.2/137.9
	4030017530	S.CER ECJ0EC1H0R5B [EXP-01]		
	4030017530	S.CER ECJ0EC1H0R5B [EUR-01]		



[MAIN UNIT]

REF NO.	ORDER NO.	DESCRIPTION	M.	H/V LOCATION
C282	4030017620	S.CER ECJ0EC1H100C [USA-01]	B	61.4/122.2
	4030017620	S.CER ECJ0EC1H100C [EXP-01]		
	4030017580	S.CER ECJ0EC1H060C [USA-02]		
	4030017580	S.CER ECJ0EC1H060C [EXP-02]		
	4030017620	S.CER ECJ0EC1H100C [EUR-01]		
C283	4030017620	S.CER ECJ0EC1H100C	B	103.7/65.9
C285	4030017620	S.CER ECJ0EC1H100C [USA-01]	B	66.1/137.9
	4030017620	S.CER ECJ0EC1H100C [EXP-01]		
	4030017580	S.CER ECJ0EC1H060C [USA-02]		
	4030017580	S.CER ECJ0EC1H060C [EXP-02]		
	4030017620	S.CER ECJ0EC1H100C [EUR-01]		
C286	4030017530	S.CER ECJ0EC1H0R5B	B	64.5/139.2
C287	4030017350	S.CER ECJ0EC1H020B [USA-01]	B	61.8/134.7
	4030017350	S.CER ECJ0EC1H020B [EXP-01]		
	4030017550	S.CER ECJ0EC1H1R5B [USA-02]		
	4030017550	S.CER ECJ0EC1H1R5B [EXP-02]		
	4030017350	S.CER ECJ0EC1H020B [EUR-01]		
C291	4030017340	S.CER ECJ0EC1H010B [USA-01]	B	102.4/66.6
	4030017340	S.CER ECJ0EC1H010B [EXP-01]		
	4030017340	S.CER ECJ0EC1H010B [EUR-01]		
C292	4030017460	S.CER ECJ0EB1E102K	B	65/136.3
C293	4030017620	S.CER ECJ0EC1H100C [USA-01]	B	62.9/137.9
	4030017620	S.CER ECJ0EC1H100C [EXP-01]		
	4030017580	S.CER ECJ0EC1H060C [USA-02]		
	4030017580	S.CER ECJ0EC1H060C [EXP-02]		
	4030017620	S.CER ECJ0EC1H100C [EUR-01]		
C294	4030017530	S.CER ECJ0EC1H0R5B	B	58.3/138.5
C295	4030017460	S.CER ECJ0EB1E102K	B	65/134.7
C296	4030017620	S.CER ECJ0EC1H100C [USA-01]	B	56.1/138
	4030017620	S.CER ECJ0EC1H100C [EXP-01]		
	4030017580	S.CER ECJ0EC1H060C [USA-02]		
	4030017580	S.CER ECJ0EC1H060C [EXP-02]		
	4030017620	S.CER ECJ0EC1H100C [EUR-01]		
C298	4030017460	S.CER ECJ0EB1E102K	B	136.2/82.9
C299	4030017460	S.CER ECJ0EB1E102K	B	50.4/133.8
C300	4030017460	S.CER ECJ0EB1E102K	B	54.1/133.9
C301	4030016790	S.CER ECJ0EB1C103K	B	51.4/133.8
C302	4030017460	S.CER ECJ0EB1E102K	B	52/138.5
C303	4030017370	S.CER ECJ0EC1H3R5B	B	131.4/82.3
C304	4030017420	S.CER ECJ0EC1H470J	B	136.2/81.9
C305	4030017420	S.CER ECJ0EC1H470J	B	46.4/133.8
C306	4030017460	S.CER ECJ0EB1E102K	B	47.4/133.8
C307	4030017460	S.CER ECJ0EB1E102K	B	45.4/138.3
C309	4030017420	S.CER ECJ0EC1H470J	B	136.8/84.5
C310	4030017380	S.CER ECJ0EC1H050B [USA-01]	B	134.9/85.9
	4030017380	S.CER ECJ0EC1H050B [EXP-01]		
	4030017370	S.CER ECJ0EC1H3R5B [USA-02]		
	4030017370	S.CER ECJ0EC1H3R5B [EXP-02]		
	4030017380	S.CER ECJ0EC1H050B [EUR-01]		
C311	4030016930	S.CER ECJ0EB1A104K	B	45.4/140.4
C312	4030017420	S.CER ECJ0EC1H470J	B	50.4/140.4
C313	4030016930	S.CER ECJ0EB1A104K	B	46.4/140.4
C314	4030017460	S.CER ECJ0EB1E102K	B	49.4/140.4
C315	4030017730	S.CER ECJ0EB1E471K	B	137.8/84.5
C316	4030017570	S.CER ECJ0EC1H040B	B	130.4/80.9
C321	4030017420	S.CER ECJ0EC1H470J	T	66/57.5
C322	4030017420	S.CER ECJ0EC1H470J	T	67.6/54.3
C323	4030017620	S.CER ECJ0EC1H100C	B	44.4/137.7
C324	4030017530	S.CER ECJ0EC1H0R5B [USA-01]	B	134.9/88.3
	4030017530	S.CER ECJ0EC1H0R5B [EXP-01]		
	4030017520	S.CER ECJ0EC1H0R3B [USA-02]		
	4030017520	S.CER ECJ0EC1H0R3B [EXP-02]		
	4030017530	S.CER ECJ0EC1H0R5B [EUR-01]		
C326	4030017580	S.CER ECJ0EC1H060C [USA-01]	B	39.3/138.2
	4030017580	S.CER ECJ0EC1H060C [EXP-01]		
	4030017590	S.CER ECJ0EC1H070C [USA-02]		
	4030017590	S.CER ECJ0EC1H070C [EXP-02]		
	4030017580	S.CER ECJ0EC1H060C [EUR-01]		
C327	4030017360	S.CER ECJ0EC1H030B [USA-01]	B	141.8/89.2
	4030017360	S.CER ECJ0EC1H030B [EXP-01]		
	4030017360	S.CER ECJ0EC1H030B [USA-02]		
	4030017360	S.CER ECJ0EC1H030B [EXP-02]		
	4030017350	S.CER ECJ0EC1H020B [EUR-01]		
C328	4030017420	S.CER ECJ0EC1H470J	B	140.9/85.4
C329	4030017410	S.CER ECJ0EC1H240J [USA-01]	B	38.4/133.5
	4030017410	S.CER ECJ0EC1H240J [EXP-01]		
	4030017390	S.CER ECJ0EC1H180J [USA-02]		
	4030017390	S.CER ECJ0EC1H180J [EXP-02]		
	4030017410	S.CER ECJ0EC1H240J [EUR-01]		
C330	4030017460	S.CER ECJ0EB1E102K	B	139.9/85.4
C331	4030017460	S.CER ECJ0EB1E102K	B	59.2/140.4
C332	4030018860	S.CER ECJ0EB0J105K	B	55/140.4
C333	4030016930	S.CER ECJ0EB1A104K	T	23.1/29.4
C335	4030017550	S.CER ECJ0EC1H1R5B	B	144/89.5
C336	4030018860	S.CER ECJ0EB0J105K	B	60.1/140.4
C337	4030017580	S.CER ECJ0EC1H060C	B	142.6/91.7
C338	4030017550	S.CER ECJ0EC1H1R5B	B	39.3/139.1
C339	4030017460	S.CER ECJ0EB1E102K	B	32.5/134
C340	4030016930	S.CER ECJ0EB1A104K	T	54/20.3
C341	4030017420	S.CER ECJ0EC1H470J	T	143.1/123.3
C342	4030017730	S.CER ECJ0EB1E471K	T	138.8/108
C345	4030017460	S.CER ECJ0EB1E102K	B	30.6/135.9
C346	4030017420	S.CER ECJ0EC1H470J	T	63.1/57.2
C347	4030017460	S.CER ECJ0EB1E102K	T	143.1/124.2
C348	4030017420	S.CER ECJ0EC1H470J	T	63.8/55.2
C349	4030017580	S.CER ECJ0EC1H060C	B	143.5/95.2
C350	4030017420	S.CER ECJ0EC1H470J	T	138.7/112.3
C351	4030017460	S.CER ECJ0EB1E102K	T	138.7/113.2
C352	4030017410	S.CER ECJ0EC1H240J [USA-01]	B	31.6/137.9
	4030017410	S.CER ECJ0EC1H240J [EXP-01]		
	4030017390	S.CER ECJ0EC1H180J [USA-02]		
	4030017390	S.CER ECJ0EC1H180J [EXP-02]		
	4030017410	S.CER ECJ0EC1H240J [EUR-01]		
C353	4030017460	S.CER ECJ0EB1E102K	T	140.4/118.8

[MAIN UNIT]

REF NO.	ORDER NO.	DESCRIPTION	M.	H/V LOCATION
C354	4030017420	S.CER ECJ0EC1H470J	T	106.6/115.9
C355	4030017580	S.CER ECJ0EC1H060C [USA-01]	B	37.5/136.8
	4030017580	S.CER ECJ0EC1H060C [EXP-01]		
	4030017590	S.CER ECJ0EC1H070C [USA-02]		
	4030017590	S.CER ECJ0EC1H070C [EXP-02]		
	4030017580	S.CER ECJ0EC1H060C [EUR-01]		
C357	4030017630	S.CER ECJ0EC1H120J	B	39.3/140
C358	4030016790	S.CER ECJ0EB1C103K	T	137.5/128.2
C359	4510009550	S.ELE EEEFK1C100R	T	107.2/86.5
C360	4030017460	S.CER ECJ0EB1E102K	T	106.6/116.8
C361	4030011030	S.CER GRM31M4C2H1R5CY21L (GRM42-6 CK) [EUR-01] only	B	100.2/115.8
C362	4030017510	S.CER ECJ0EC1H680J	B	39.7/144.6
C364	4030011020	S.CER GRM31M4C2H1R0CY21L (GRM42-6 CK)	B	89.8/119.8
C365	4030017730	S.CER ECJ0EB1E471K	T	106.6/117.7
C366	4030016970	S.CER ECJ0EB1C223K	T	142.4/126.6
C367	4510009810	S.ELE EEEFK1E220R	T	107.3/95.1
C368	4030006860	S.CER C1608 JB 1H 102K-T	B	89.1/142
C369	4030017460	S.CER ECJ0EB1E102K	T	33.4/134
C370	4030011060	S.CER GRM31M2C2H4R0CY21L (GRM42-6 CH) [USA-01]	B	100.2/123.1
	4030011060	S.CER GRM31M2C2H4R0CY21L (GRM42-6 CH) [EXP-01]		
	4030011070	S.CER GRM31M2C2H5R0CY21L (GRM42-6 CH) [EUR-01]		
C371	4030006980	S.CER C1608 CH 1H 070D-T	T	35.5/142.5
C372	4030011100	S.CER GRM31M2C2H8R0DV01L (GRM42-6 CH)	B	100.2/121
C373	4030017780	S.CER ECJ0EB1E472K	T	136.7/123.8
C374	4030017420	S.CER ECJ0EC1H470J	B	85.2/129.8
C375	4030017460	S.CER ECJ0EB1E102K	T	113.1/95.2
C376	4030017350	S.CER ECJ0EC1H020B	B	86/138.8
C377	4030017420	S.CER ECJ0EC1H470J	B	84.2/119.4
C378	4030017420	S.CER ECJ0EC1H470J	T	112.2/95.2
C381	4030017400	S.CER ECJ0EC1H220J	T	111.3/95.2
C383	4030017460	S.CER ECJ0EB1E102K	T	114/78.2
C385	4030017460	S.CER ECJ0EB1E102K	B	22.8/142.4
C386	4030017460	S.CER ECJ0EB1E102K	T	139.2/119.6
C387	4030017600	S.CER ECJ0EC1H080C	B	89.7/137.9
C388	4510009550	S.ELE EEEFK1C100R	T	126.4/77.2
C389	4030017200	S.CER GRM31BR32J102KY01L (GHH1030 R)	B	96.8/130.4
C390	4030011070	S.CER GRM31M2C2H5R0CY21L (GRM42-6 CH)	B	87.6/133.2
C391	4030017460	S.CER ECJ0EB1E102K	T	122.2/76
C392	4030017520	S.CER ECJ0EC1H0R3B	B	95.4/134.3
C393	4030011050	S.CER GRM31M3C2H3R0CY21L (GRM42-6 CJ)	B	98.4/126.8
C394	4550006250	S.TAN TEESVA 1A 106M8R	B	26.3/15.3
C395	4030011050	S.CER GRM31M3C2H3R0CY21L (GRM42-6 CJ)	B	100.5/126.9
C396	4510009550	S.ELE EEEFK1C100R	T	97/77.8
C397	4030017460	S.CER ECJ0EB1E102K	T	137.4/118.5
C398	4550006250	S.TAN TEESVA 1A 106M8R	B	31.7/15.5
C399	4030017460	S.CER ECJ0EB1E102K	T	100/76.2
C400	4030017460	S.CER ECJ0EB1E102K	B	86.2/129.8
C401	4030011080	S.CER GRM31M2C2H6R0DV01L (GRM42-6 CH)	B	103.2/130.9
C402	4030016930	S.CER ECJ0EB1A104K	T	47.2/71.6
C403	4030011050	S.CER GRM31M3C2H3R0CY21L (GRM42-6 CJ)	B	106.2/130.9
C404	4030017460	S.CER ECJ0EB1E102K	T	140.7/129.2
C405	4030017420	S.CER ECJ0EC1H470J	B	56.7/55.3
C406	4030016790	S.CER ECJ0EB1C103K	T	103.5/76.2
C407	4030011030	S.CER GRM31M4C2H1R5CY21L (GRM42-6 CK)	B	102.6/137.2
C408	4030017460	S.CER ECJ0EB1E102K	B	98.1/138.5
C409	4030011050	S.CER GRM31M3C2H3R0CY21L (GRM42-6 CJ)	B	110.9/136
C410	4030011050	S.CER GRM31M3C2H3R0CY21L (GRM42-6 CJ) [USA-01]	B	113/134
	4030011050	S.CER GRM31M3C2H3R0CY21L (GRM42-6 CJ) [EXP-01]		
	4030011060	S.CER GRM31M2C2H4R0CY21L (GRM42-6 CH) [USA-02]		
	4030011060	S.CER GRM31M2C2H4R0CY21L (GRM42-6 CH) [EXP-02]		
	4030011050	S.CER GRM31M3C2H3R0CY21L (GRM42-6 CJ) [EUR-01]		
C411	4550007650	S.TAN F931V105MAABMA	T	37.5/68.6
C412	4030017460	S.CER ECJ0EB1E102K	T	112.6/78.5
C413	4030016930	S.CER ECJ0EB1A104K	T	38.5/71.9
C414	4030017420	S.CER ECJ0EC1H470J	B	29.7/135.9
C415	4550007650	S.TAN F931V105MAABMA	T	37.5/63.4
C416	4550006250	S.TAN TEESVA 1A 106M8R	T	107.8/81.5
C417	4030016930	S.CER ECJ0EB1A104K		

[MAIN UNIT]

REF NO.	ORDER NO.	DESCRIPTION	M.	H/V LOCATION
C426	4030009530	S.CER C1608 CH 1H 030B-T [USA-02]		
	4030009530	S.CER C1608 CH 1H 030B-T [EXP-02]		
	4030009540	S.CER C1608 CH 1H 1R5B-T [EUR-01]		
C431	4030018860	S.CER ECJ0EB0J105K	B	33.3/13.6
C432	4030016930	S.CER ECJ0EB1A104K	T	10.8/120.6
C433	4030006860	S.CER C1608 JB 1H 102K-T	B	139.5/137.7
C434	4030017460	S.CER ECJ0EB1E102K	B	140.5/131
C435	4030017460	S.CER ECJ0EB1E102K	T	54.8/29.8
C436	4030011050	S.CER GRM31M3C2H3R0CY21L [USA-01]	B	144.8/138.6
	4030011050	S.CER GRM31M3C2H3R0CY21L [EXP-01]		
	4030011050	S.CER GRM31M3C2H3R0CY21L [USA-02]		
	4030011040	S.CER GRM31M4C2H2R0CY21L [EXP-02]		
	4030011040	S.CER GRM31M4C2H2R0CY21L [EUR-01]		
C437	4030016930	S.CER ECJ0EB1A104K	B	34.4/12
C438	4030016790	S.CER ECJ0EB1C103K	T	112.8/88.2
C439	4510009810	S.ELE EEEFK1E220R	T	128.4/89.8
C440	4030018900	S.CER ECJ0EB0J474K	T	7.9/129.6
C441	4030017440	S.CER ECJ0EC1H221J	T	12/126.2
C442	4510008780	S.ELE EEE1EA471P	B	9.6/119.8
C443	4030017460	S.CER ECJ0EB1E102K	T	111.9/88.2
C444	4030011070	S.CER GRM31M2C2H5R0CY21L [USA-01]	B	147/148.9
	4030011070	S.CER GRM31M2C2H5R0CY21L [EXP-01]		
	4030011070	S.CER GRM31M2C2H5R0CY21L [USA-02]		
	4030011060	S.CER GRM31M2C2H4R0CY21L [EXP-02]		
	4030011060	S.CER GRM31M2C2H4R0CY21L [EUR-01]		
C446	4030017460	S.CER ECJ0EB1E102K	T	6.6/130.1
C448	4030017460	S.CER ECJ0EB1E102K	T	128.8/102.4
C449	4510008870	S.ELE EEE1AA471UP	B	8.9/139.2
C450	4030016930	S.CER ECJ0EB1A104K	T	7/125.3
C451	4030018860	S.CER ECJ0EB0J105K	T	8.6/125.3
C452	4030018860	S.CER ECJ0EB0J105K	T	72/98.2
C453	4030017460	S.CER ECJ0EB1E102K	T	130.8/103.6
C454	4030017430	S.CER ECJ0EC1H101J	B	46.3/56.9
C458	4030017460	S.CER ECJ0EB1E102K	T	114.8/95.7
C459	4030017460	S.CER ECJ0EB1E102K	T	116.3/119.1
C460	4030017460	S.CER ECJ0EB1E102K	B	9.6/147.3
C461	4030017420	S.CER ECJ0EC1H470J	T	114.8/94.8
C462	4030017420	S.CER ECJ0EC1H470J	T	115.3/119.1
C463	4030017420	S.CER ECJ0EC1H470J	B	9.6/146.4
C464	4510009680	S.ELE EEEFK1E471P	B	144.4/121.1
C465	4550006250	S.TAN TEESVA 1A 106M8R	T	102.7/92
C466	4030017420	S.CER ECJ0EC1H470J	T	99.9/88
C467	4030016930	S.CER ECJ0EB1A104K	T	62.3/58.5
C468	4030016930	S.CER ECJ0EB1A104K	T	61.7/56.9
C470	4030018860	S.CER ECJ0EB0J105K	T	7.4/122.3
C471	4030016790	S.CER ECJ0EB1C103K	T	7/124.4
C472	4030018860	S.CER ECJ0EB0J105K	T	10.9/117.7
C473	4030018860	S.CER ECJ0EB0J105K	T	5/118.9
C474	4030017780	S.CER ECJ0EB1E472K	T	115.3/17.6
C475	4510008120	S.ELE 16 CE 100 BS	T	125.1/12.1
C476	4510008120	S.ELE 16 CE 100 BS	T	125.1/19.3
C477	4030017780	S.CER ECJ0EB1E472K	T	119/12.3
C478	4030017780	S.CER ECJ0EB1E472K	T	115.3/12.2
C479	4510008120	S.ELE 16 CE 100 BS	T	104.8/14.3
C481	4030017460	S.CER ECJ0EB1E102K	B	63.2/122.2
C491	4030016930	S.CER ECJ0EB1A104K	T	60.4/60.1
C492	4030016930	S.CER ECJ0EB1A104K	B	13.5/32.6
C493	4510008870	S.ELE EEE1AA471UP	B	66.3/45.3
C494	4030016930	S.CER ECJ0EB1A104K	T	117.2/92.6
C495	4030016930	S.CER ECJ0EB1A104K	T	117.2/90.7
C496	4030016930	S.CER ECJ0EB1A104K	T	122.4/92.2
C497	4030016930	S.CER ECJ0EB1A104K	T	109.7/82
C498	4030016930	S.CER ECJ0EB1A104K	T	11.4/43.2
C501	4030017420	S.CER ECJ0EC1H470J	T	12.2/31.2
C502	4030017420	S.CER ECJ0EC1H470J	T	29.5/2.8
C503	4030017420	S.CER ECJ0EC1H470J	T	48/99.4
C506	4030016930	S.CER ECJ0EB1A104K	B	26.3/43.3
C507	4030016930	S.CER ECJ0EB1A104K	B	32.9/31
C508	4030016930	S.CER ECJ0EB1A104K	B	40.1/42.7
C509	4030016930	S.CER ECJ0EB1A104K	B	26.2/39
C510	4030016930	S.CER ECJ0EB1A104K	B	26.6/33
C511	4030016930	S.CER ECJ0EB1A104K	B	40.1/34.2
C512	4030017420	S.CER ECJ0EC1H470J	T	92/14.7
C513	4550006250	S.TAN TEESVA 1A 106M8R	B	8.4/59.8
C514	4030016930	S.CER ECJ0EB1A104K	B	11.7/53.5
C515	4030016930	S.CER ECJ0EB1A104K	B	15.5/54.4
C516	4030016930	S.CER ECJ0EB1A104K	T	65.1/69.6
C517	4030016930	S.CER ECJ0EB1A104K	B	15.6/63.1
C518	4030016930	S.CER ECJ0EB1A104K	B	12.4/62.4
C519	4030017460	S.CER ECJ0EB1E102K	B	15.6/59.9
C521	4030016930	S.CER ECJ0EB1A104K	B	18.1/53.6
C522	4030016930	S.CER ECJ0EB1A104K	T	51.2/31.8
C523	4030016930	S.CER ECJ0EB1A104K	T	51.2/33
C524	4030018910	S.CER C1608 JB 0J 475K-T	T	9.5/56
C525	4030018910	S.CER C1608 JB 0J 475K-T	B	25.8/58.3
C526	4030017730	S.CER ECJ0EB1E471K	B	29.8/57.9
C527	4030016790	S.CER ECJ0EB1C103K	B	26.1/50.3
C528	4030017670	S.CER ECJ0EC1H390J	B	37.4/120.7
C529	4030017630	S.CER ECJ0EC1H120J	B	38.3/112.2
C530	4030017420	S.CER ECJ0EC1H470J	T	60.4/62.3
C531	4030017670	S.CER ECJ0EC1H390J	B	93.3/62
C532	4030017670	S.CER ECJ0EC1H390J	B	93.6/52.9
C533	4510008120	S.ELE 16 CE 100 BS	T	125.1/26.4
C534	4030016790	S.CER ECJ0EB1C103K	T	118.5/26.7

[MAIN UNIT]

REF NO.	ORDER NO.	DESCRIPTION	M.	H/V LOCATION
C535	4030016790	S.CER ECJ0EB1C103K	B	67.4/101.6
C536	4030016790	S.CER ECJ0EB1C103K	B	65.7/98.3
C538	4030006860	S.CER C1608 JB 1H 102K-T	T	36.2/145.1
C539	4030017790	S.CER ECJ0EB1E682K	T	22.8/57
C540	4030017730	S.CER ECJ0EB1E471K	T	21.2/56.6
C541	4030016930	S.CER ECJ0EB1A104K	T	22.8/55.4
C542	4030017440	S.CER ECJ0EC1H221J	T	27.1/55
C543	4030016930	S.CER ECJ0EB1A104K	T	56.5/68.9
C544	4030017460	S.CER ECJ0EB1E102K	T	62.4/72.9
C545	4030011060	S.CER GRM31M2C2H4R0CY21L [USA-01]	T	97.6/106.8
	4030011060	S.CER GRM31M2C2H4R0CY21L [EXP-01]		
	4030011050	S.CER GRM31M3C2H3R0CY21L [USA-02]		
	4030011050	S.CER GRM31M3C2H3R0CY21L [EXP-02]		
	4030011060	S.CER GRM31M2C2H4R0CY21L [EUR-01]		
C546	4030018910	S.CER C1608 JB 0J 475K-T	B	40.4/56.7
C547	4030017760	S.CER ECJ0EB1H222K	T	53.7/72.1
C548	4030016930	S.CER ECJ0EB1A104K	T	14.1/120.6
C549	4030017420	S.CER ECJ0EC1H470J	T	23.1/86.8
C550	4030017420	S.CER ECJ0EC1H470J	T	70.1/82.6
C551	4030017330	S.CER ECJ0EF1C104Z	T	114.2/28.9
C552	4030016790	S.CER ECJ0EB1C103K	B	121.9/48.8
C553	4030016930	S.CER ECJ0EB1A104K	B	30.8/19.4
C555	4030016930	S.CER ECJ0EB1A104K	B	69.8/75.5
C556	4030016930	S.CER ECJ0EB1A104K	T	105.2/28.6
C557	4030016930	S.CER ECJ0EB1A104K	T	97/28.6
C558	4550006250	S.TAN TEESVA 1A 106M8R	T	95.1/27.9
C559	4550007080	S.TAN TEESVA 1C 106M8R	T	45.9/75.5
C562	4030017420	S.CER ECJ0EC1H470J	T	38.5/76.1
C563	4030016930	S.CER ECJ0EB1A104K	B	26.5/122.3
C564	4030017570	S.CER ECJ0EC1H040B	B	68.3/131.3
C565	4030017340	S.CER ECJ0EC1H010B	B	47.9/113.5
C566	4030018860	S.CER ECJ0EB0J105K	B	39/72.7
C571	4030017580	S.CER ECJ0EC1H060C	T	64.6/99.1
C572	4030017580	S.CER ECJ0EC1H060C	T	65.6/99.1
C573	4030017580	S.CER ECJ0EC1H060C	T	65.3/97.4
C574	4030017580	S.CER ECJ0EC1H060C	B	64/134.7
C575	4030017420	S.CER ECJ0EC1H470J	B	62.9/132.4
C576	4030017460	S.CER ECJ0EB1E102K	T	67.1/106.5
C577	4030017460	S.CER ECJ0EB1E102K	T	67.1/104.9
C578	4030017200	S.CER GRM31BR32J102KY01L (GHM1030 R)	T	92/126
C579	4550006250	S.TAN TEESVA 1A 106M8R	B	94.7/50.6
C580	4030017420	S.CER ECJ0EC1H470J	T	100.7/73.5
C581	4030018910	S.CER C1608 JB 0J 475K-T	B	46.3/60.9
C582	4030018910	S.CER C1608 JB 0J 475K-T	T	69.7/98.2
C583	4030016930	S.CER ECJ0EB1A104K	B	46.3/58.6
C584	4030016790	S.CER ECJ0EB1C103K	B	54.9/55.3
C585	4030016930	S.CER ECJ0EB1A104K	B	54.9/58.6
C586	4030017730	S.CER ECJ0EB1E471K	B	54.9/56.9
C587	4030016790	S.CER ECJ0EB1C103K	B	52.3/59.8
C588	4030018910	S.CER C1608 JB 0J 475K-T	T	70.9/98.2
C601	4030011060	S.CER GRM31M2C2H4R0CY21L [USA-01]	T	97.6/111.3
	4030011060	S.CER GRM31M2C2H4R0CY21L [EXP-01]		
	4030011060	S.CER GRM31M2C2H4R0CY21L [USA-02]		
	4030011060	S.CER GRM31M2C2H4R0CY21L [EXP-02]		
	4030011070	S.CER GRM31M2C2H5R0CY21L [EUR-01]		
C610	4030018080	S.CER ECJ0EB1H182K	T	63.3/69.6
C612	4030017460	S.CER ECJ0EB1E102K	B	55.7/29.9
C614	4030017730	S.CER ECJ0EB1E471K	B	29/13.2
C615	4030017650	S.CER ECJ0EC1H270J	B	63.2/117.5
C616	4030017460	S.CER ECJ0EB1E102K	T	93.8/64.6
C617	4030017420	S.CER ECJ0EC1H470J	T	60/64.8
C618	4030017420	S.CER ECJ0EC1H470J	T	64.9/53.3
C619	4030017420	S.CER ECJ0EC1H470J	T	74.2/107.7
C620	4030017420	S.CER ECJ0EC1H470J	T	73.7/96.8
C621	4030017420	S.CER ECJ0EC1H470J	T	31.5/2.8
C622	4030018910	S.CER C1608 JB 0J 475K-T	T	64.3/73.2
C623	4030017330	S.CER ECJ0EF1C104Z	B	126.8/16
C624	4030017330	S.CER ECJ0EF1C104Z	B	126.3/20.3
C625	4030017460	S.CER ECJ0EB1E102K	B	126.8/17.2
C626	4510009810	S.ELE EEEFK1E220R	B	129.4/23
C630	4030017420	S.CER ECJ0EC1H470J [EUR-01] only	T	106.4/106.8
C631	4030017580	S.CER ECJ0EC1H060C [EUR-01] only	T	113.5/108.3
C637	4510009680	S.ELE EEEFK1E471P	B	84.9/23.4
J1	6510026770	S.CON AXK540147YG	T	23.1/63.7
J2	6510023092	S.CON 20FLT-SM2-TB(LF)(SN)(M)	T	14.8/15.6
J4	6510023511	S.CON 28FLT-SM		

**[MAIN UNIT]**

REF NO.	ORDER NO.	DESCRIPTION	M.	H/V LOCATION
W1	7120000470	JUM ERDS2T0		
W2	7120000470	JUM ERDS2T0		
W4	8900017520	CAB OPC-1783		
EP1	6910015370	S.BEA ACZ1005Y-102-T	B	129.1/48.4
EP2	6910015370	S.BEA ACZ1005Y-102-T	B	117.2/48.4
EP3	6910015370	S.BEA ACZ1005Y-102-T	B	32.4/81.6
EP4	6910016330	S.BEA MMZ1005S 601CT-S	B	30.4/60.5
EP5	6910015370	S.BEA ACZ1005Y-102-T	B	39/74.5
EP6	6910015370	S.BEA ACZ1005Y-102-T	B	37.8/109
EP7	6910016330	S.BEA MMZ1005S 601CT-S	B	40.7/36.7
EP8	6910015370	S.BEA ACZ1005Y-102-T	B	94.5/48.8
EP9	6910016330	S.BEA MMZ1005S 601CT-S	T	48.8/39.3
EP10	6910011560	BEA HF70BB4.5X5X1.6		
EP13	6910011330	TER OT-009 M3		
EP14	6910011330	TER OT-009 M3		

**[CONNECT UNIT]**

REF NO.	ORDER NO.	DESCRIPTION	M.	H/V LOCATION
C601	4030017420	S.CER ECJ0EC1H470J	T	13.8/12.4
C602	4030017400	S.CER ECJ0EC1H220J	T	12.2/12.4
C603	4030017420	S.CER ECJ0EC1H470J	T	16.5/12.4
C604	4030017400	S.CER ECJ0EC1H220J	T	15/14.2
C605	4030017420	S.CER ECJ0EC1H470J	T	17.8/13.9
C606	4030017420	S.CER ECJ0EC1H470J	T	19.4/12.4
C607	4030017420	S.CER ECJ0EC1H470J	T	20.5/13.9
C608	4030017420	S.CER ECJ0EC1H470J	T	22.6/12.4
C609	4030017420	S.CER ECJ0EC1H470J	T	25.5/12.4
C610	4030017420	S.CER ECJ0EC1H470J	T	29.7/12.8
C611	4030017420	S.CER ECJ0EC1H470J	T	31/14.1
C612	4030017420	S.CER ECJ0EC1H470J	T	32.4/12.8
C613	4030017420	S.CER ECJ0EC1H470J	T	33.5/14.1
C614	4030017420	S.CER ECJ0EC1H470J	T	35.2/14.1
C615	4030017420	S.CER ECJ0EC1H470J	T	35.7/12.8
C616	4030017420	S.CER ECJ0EC1H470J	B	35.2/15.6
C617	4030017420	S.CER ECJ0EC1H470J	T	37.5/13.5
C618	4030017420	S.CER ECJ0EC1H470J	T	39.3/12.2
C619	4030017420	S.CER ECJ0EC1H470J	T	39.9/13.4
C620	4030017420	S.CER ECJ0EC1H470J	T	41.3/12.6
C621	4030017420	S.CER ECJ0EC1H470J	T	27.4/13.9
J601	6510026290	S.CON IMSA-9631S-28Y921	B	22.8/16.2
J602	6510023210	CON CD6125SA1J0 <CVI>		
S1	2260003070	S.SWI MINISMDC150F/24-2	B	38.9/18
W601	8900017500	CAB OPC-1852 (P0.5,N28,L90) <TJM>		

M.=Mounted side (T: Mounted on the Top side, B: Mounted on the Bottom side)  
S.=Surface mount







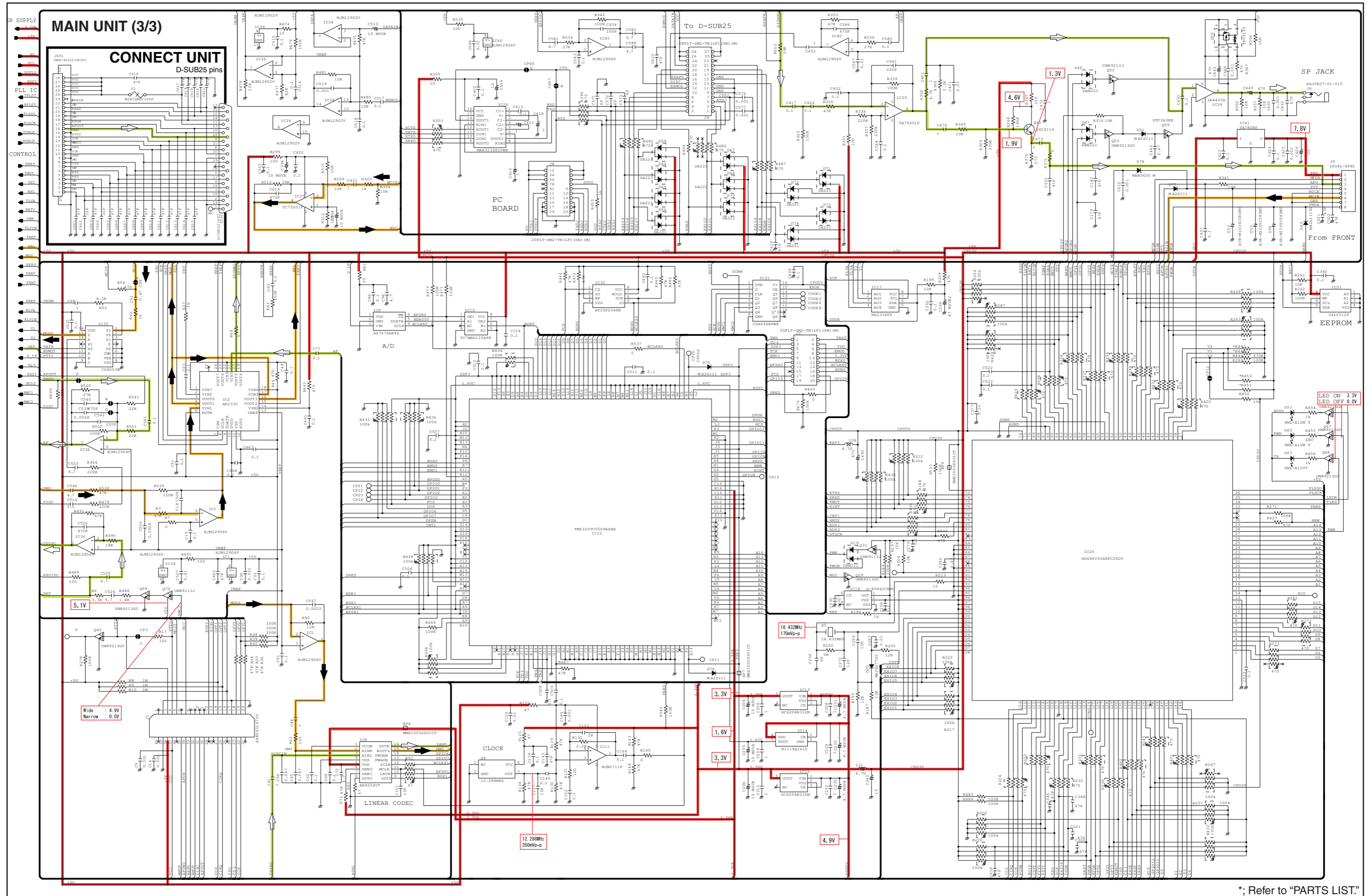

\*; Refer to "PARTS LIST."



# SERVICE MANUAL

CHANNEL EXTENSION MODULE  
**UR-FR6000**  
**UR-FR6100**

---

---

---

---

S-14506XZ-C1  
May. 2008

## INTRODUCTION

This service manual describes the latest service information for the **UR-FR6000** UHF DIGITAL REPEATER at the time of publication.

MODEL	VERSION	FREQUENCY RANGE	CH. SPACING
UR-FR6000	USA-01	400–470 MHz	6.25/12.5/25.0 kHz
	EXP-01	(Low band)	12.5/25.0 kHz
	USA-02	450–520 MHz	6.25/12.5/25.0 kHz
	EXP-02	(High band)	12.5/25.0 kHz
UR-FR6100	EUR-01	400–470 MHz (Low band)	12.5/20.0/25.0 kHz

### UNIT ABBREVIATIONS:

M=MAIN UNIT  
CN=CONNECT UNIT

## CAUTION

**NEVER** connect the repeater to an AC outlet or to a DC power supply that uses more than specified. This will ruin the repeater.

**DO NOT** expose the repeater to rain, snow or any liquids.

**DO NOT** reverse the polarities of the power supply when connecting the repeater.

**DO NOT** apply an RF signal of more than 20 dBm (100 mW) to the antenna connector. This could damage the repeater's front-end.

To upgrade quality, any electrical or mechanical parts and internal circuits are subject to change without notice or obligation.



## ORDERING PARTS

Be sure to include the following four points when ordering replacement parts:

1. 10-digit Icom parts numbers
2. Component name
3. Equipment model name and unit name
4. Quantity required

### <ORDER EXAMPLE>

1110003491 S.IC TA31136FNG UR-FR6000 MAIN UNIT 2 pieces  
8820001210 Screw 2438 screw UR-FR6000 Top cover 10 pieces

Addresses are provided on the inside back cover for your convenience.

## REPAIR NOTES

1. Make sure the problem is internal before disassembling the repeater.
2. **DO NOT** open the repeater until the repeater is disconnected from its power source.
3. **DO NOT** force any of the variable components. Turn them slowly and smoothly.
4. **DO NOT** short any circuits or electronic parts. An insulated tuning tool **MUST** be used for all adjustments.
5. **DO NOT** keep power ON for a long time when the repeater is defective.
6. **DO NOT** transmit power into a Standard Signal Generator or a Sweep Generator.
7. **ALWAYS** connect a 50 dB to 60 dB attenuator between the repeater and a Deviation Meter or Spectrum Analyzer when using such test equipment.
8. **READ** the instructions of test equipment thoroughly before connecting a test equipment to the repeater.



---

## CONTENTS

---

**SECTION 1 SPECIFICATIONS**

**SECTION 2 INSIDE VIEWS**

**SECTION 3 DISASSEMBLY INSTRUCTION**

**SECTION 4 OPTIONAL UNIT INSTALLATION**

**SECTION 5 CIRCUIT DESCRIPITON**

5-1	RECEIVER CIRCUITS.....	5-1
5-2	TRANSMITTER CIRCUITS.....	5-1
5-3	OTHER CIRCUITS.....	5-2
5-4	CPU (M: IC20) PORT ALLOCATION.....	5-3

**SECTION 6 ADJUSTMENT PROCEDURES**

6-1	PREPARATION.....	6-1
6-2	FREQUENCY ADJUSTMENT.....	6-6
6-3	TRANSMIT ADJUSTMENT.....	6-7
6-4	RECEIVE ADJUSTMENT.....	6-8

**SECTION 7 PARTS LIST**

**SECTION 8 MECHANICAL PARTS**

**SECTION 9 BOARD LAYOUTS**

**SECTION 10 BLOCK DIAGRAM**

**SECTION 11 VOLTAGE DIAGRAM**

	MAIN UNIT (1/3).....	11-1
	MAIN UNIT (2/3).....	11-2
	MAIN UNIT (3/3).....	11-3
	CONNECT UNIT.....	11-4

# SECTION 1

# SPECIFICATIONS

■ GENERAL	[UR-FR6000]	[UR-FR6100]
• Frequency coverage	400–470 MHz [USA-01], [EXP-01] 450–520 MHz [USA-02], [EXP-02]	400–470 MHz
• Conventional channels	max. 32 ch	
• Type of emission	Wide 16K0F3E	
	–	Middle 14K0F3E
	Narrow 11K0F3E/11K0F7E/11K0F7D/11K0F7W	Narrow 8K50F3E
	Digital 4K00F1E/4K00F1D/4K00F3E	
• Antenna impedance	50 Ω (Nominal)	
• Operating temperature range	–22°F to +140°F (–30°C to +60°C)	–25°C to +55°C
• Power supply requirement (nominal)	13.6 V DC (Negative ground)	13.2 V DC (Negative ground)
• Current drain (Approx.)	Receiving 500 mA (stand-by), 1900 mA (max. audio)	
	Transmitting 15.0 A (at 50 W)	Transmitting 7.0 A (at 25 W)
• Weight (Approx.)	4 lb <sup>27</sup> / <sub>32</sub> oz.	2.2 kg

■ TRANSMITTER	[UR-FR6000]	[UR-FR6100]
• Output power	50 W	25 W
• Modulation	Variable reactance frequency modulation	
• Max. permissible deviation	±5.0 kHz (Wide)	
	–	±4.0 kHz (Middle)
	±2.5 kHz (Narrow)	
• Frequency stability	±0.5 ppm	±0.5 kHz
• Spurious emissions	80 dB typ.	0.25 μW (≤1 GHz), 1.00 μW (>1 GHz)
• Adjacent channel power	Wide 73 dB typ.	Wide 73 dB min.
	–	Middle 73 dB min.
	Narrow 67 dB typ.	Narrow 65 dB min.
	Digital 65 dB typ.	Digital 60 dB min.
• Audio harmonic distortion	1% typ. (at AF 1 kHz 40% deviation)	
• Audio frequency response	+2 dB to –8 dB of 6 dB/oct. Wide/Middle from 300 Hz–3000 Hz Narrow from 300 Hz–2550 Hz	
• FM Hum and noise (300 Hz–3000 Hz, 750 us)	Wide 50 dB typ. Narrow 45 dB typ.	
• Intermodulation attenuation	–	40 dB min.

■ RECEIVER	[UR-FR6000]	[UR-FR6100]
• Receive system	Double-conversion superheterodyne system	
• Intermediate frequencies	1st IF: 46.35 MHz, 2nd IF: 450 kHz	
• Sensitivity	Wide/Narrow 0.25 $\mu$ V typ. at 12 dB SINAD	Wide/Middle/Narrow –10 dB $\mu$ max. at 12 dB SINAD
	Digital 0.25 $\mu$ V typ. at 5% BER	Digital 0 dB $\mu$ V emf max. at 1% BER (PN9)
• Squelch sensitivity (at threshold)	Wide/Narrow 0.25 $\mu$ V typ.	Wide/Middle/Narrow 0.25 $\mu$ V typ.
• Adjacent channel selectivity	Wide 78 dB typ.	Wide 70 dB min.
	–	Middle 70 dB min.
	Narrow 56 dB typ.	Narrow 60 dB min.
	Digital 63 dB typ.	Digital 45 dB min.
• Spurious response	Wide/Narrow 70 dB	Wide/Middle/Narrow 70 dB min.
	Digital 65 dB $\mu$ V emf	Digital 70 dB $\mu$ V emf min.
• Intermodulation	Wide 70 dB min.	
	–	Middle 70 dB min.
	Narrow 70 dB min.	
	Digital 71 dB $\mu$ V emf min.	
• Hum and noise	Wide 50 dB typ.	Wide 45 dB min.
	–	Middle 43 dB min.
	Narrow 45 dB typ.	Narrow 40 dB min.
	Digital 55 dB typ.	Digital 55 dB min.
• Audio output power (at 5% distortion with a 4 $\Omega$ load)	4.0 W typ.	3.5 W min.
• Audio output impedance	4 $\Omega$	

Specifications are measured in accordance with TIA-603-B (for Wide and Narrow) or EN 301 166 (Digital) for UR-FR6000.

Specifications are measured in accordance with EN 300 086 (for Wide, Middle and Narrow) or EN 301 166 (Digital) for UR-FR6100.

**All stated specifications are subject to change without notice or obligation.**



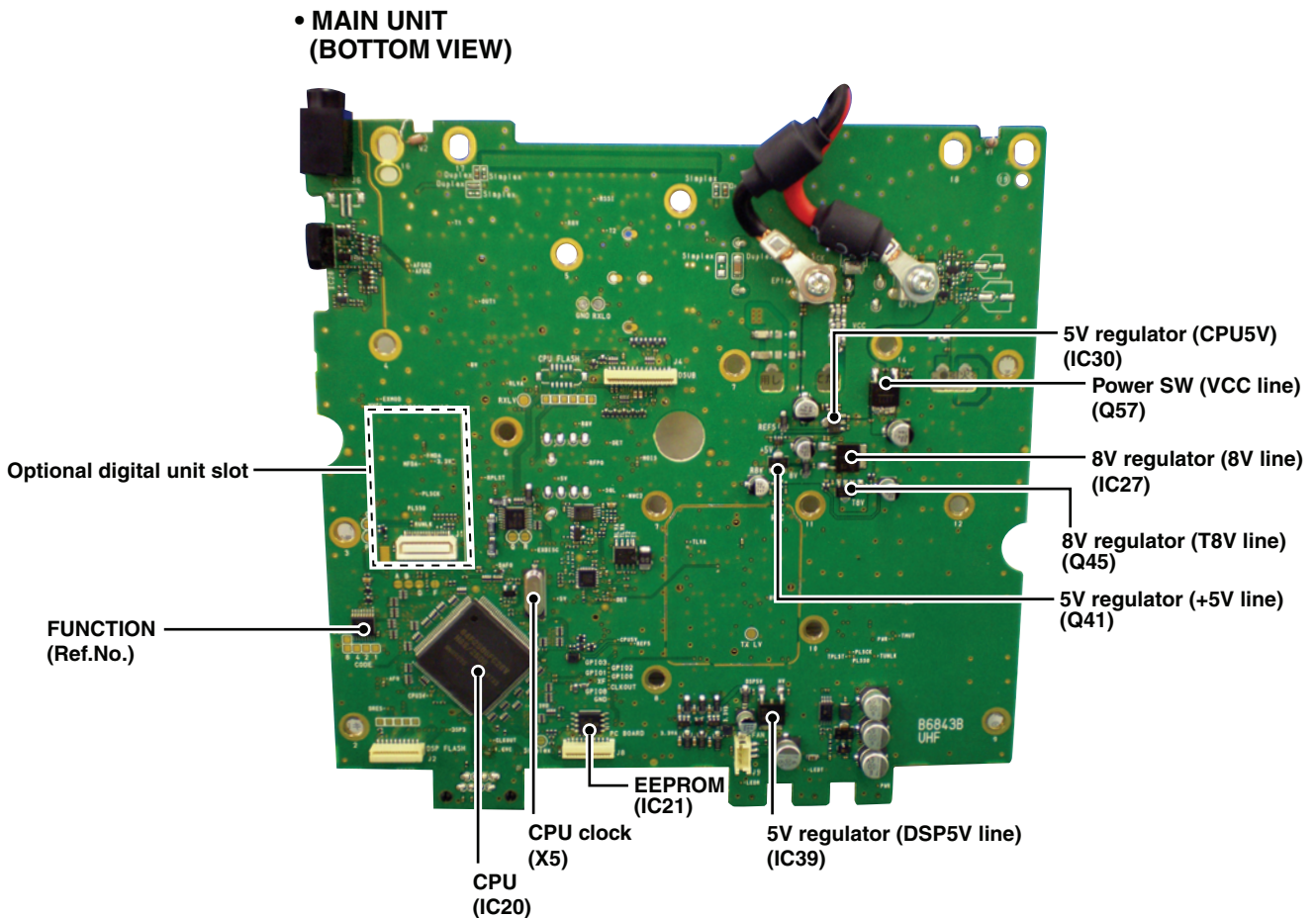
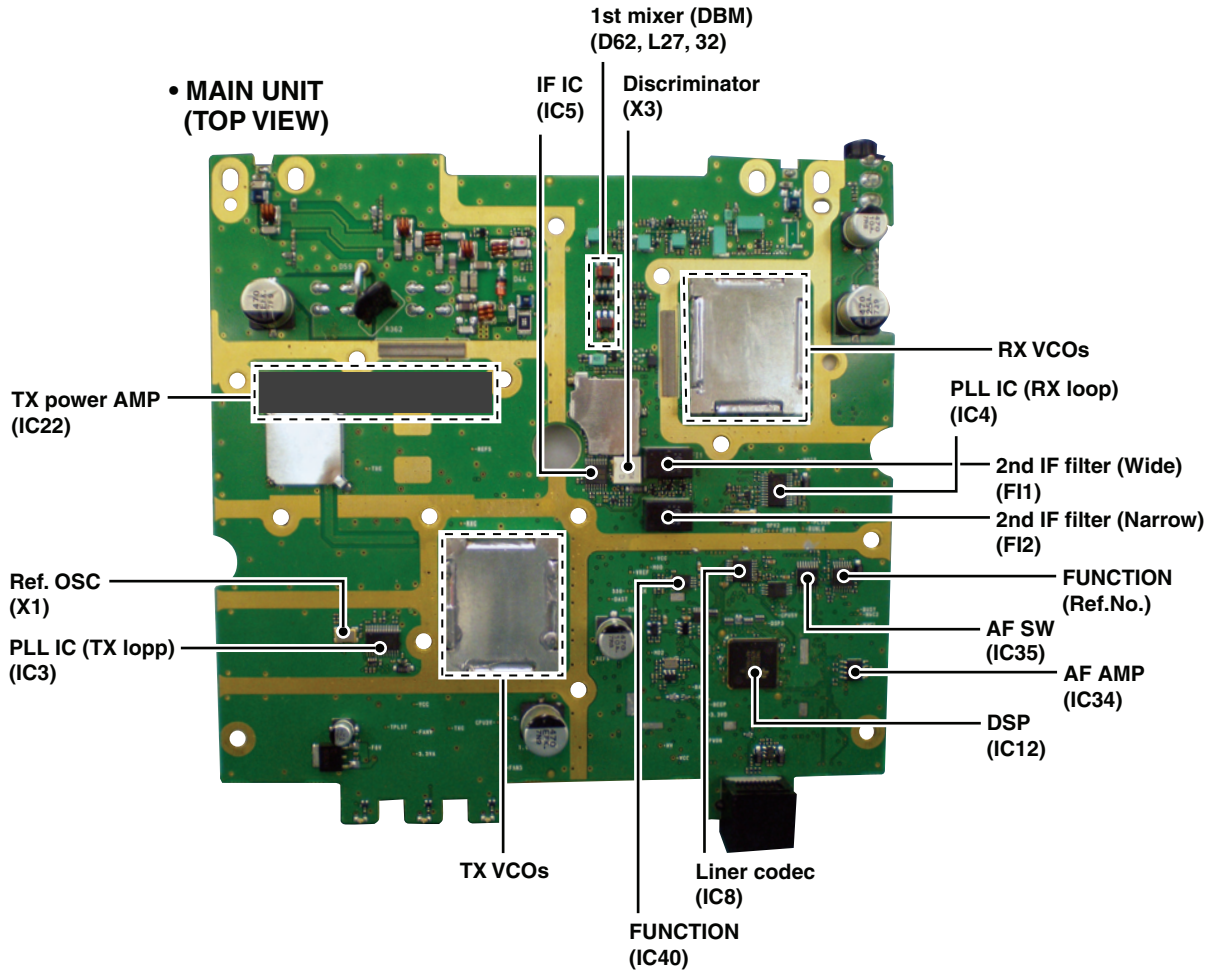

# SECTION 3 DISASSEMBLY INSTRUCTION

## • Removing the MAIN UNIT

① Unscrew 9 screws, and remove the cover.

(If you are going to install an optional unit, see page 4-1 for the installation.)

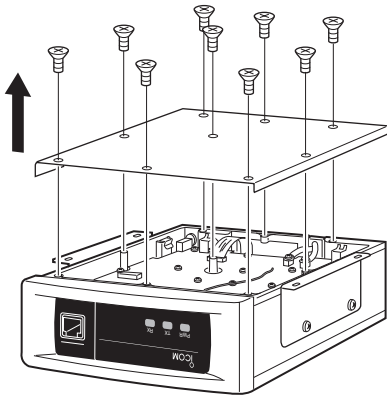

- ② Unsolder 2 points at the ANT cases.
- ③ Unscrew 4 screws from the ANT cases, and remove them.
- ④ Disconnect the flat cable from J4 and the speaker cable from J9.

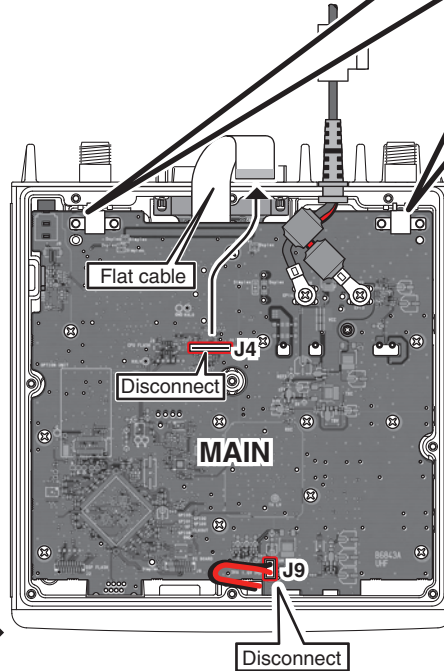
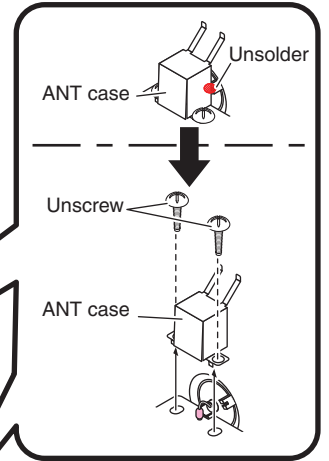

- ⑤ Unsolder 2 points at the bottom of ANT connectors.
- ⑥ Unsolder 4 points at the PA module leads.
- ⑦ Unscrew 2 screws from W4.

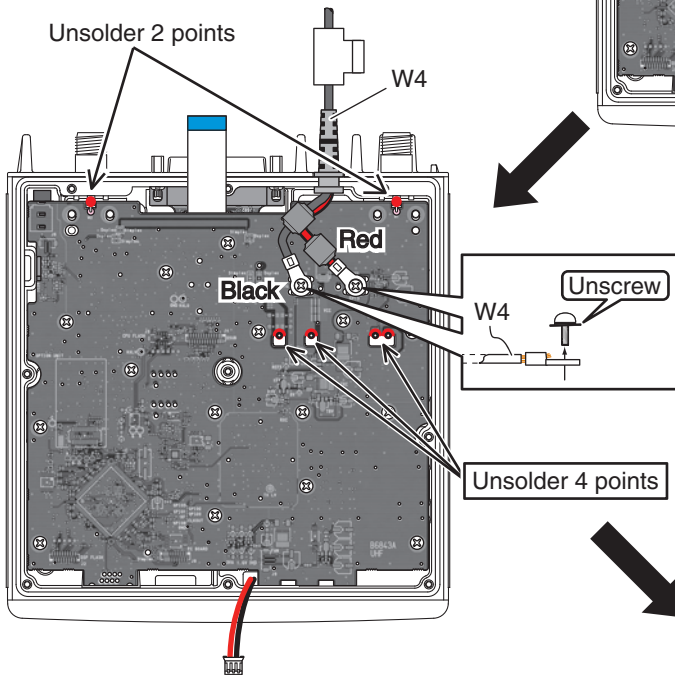

- ⑧ Remove the clip from the side of chassis.
- ⑨ Unscrew 15 screws from the MAIN UNIT, then take off the MAIN UNIT PCB from the chassis.

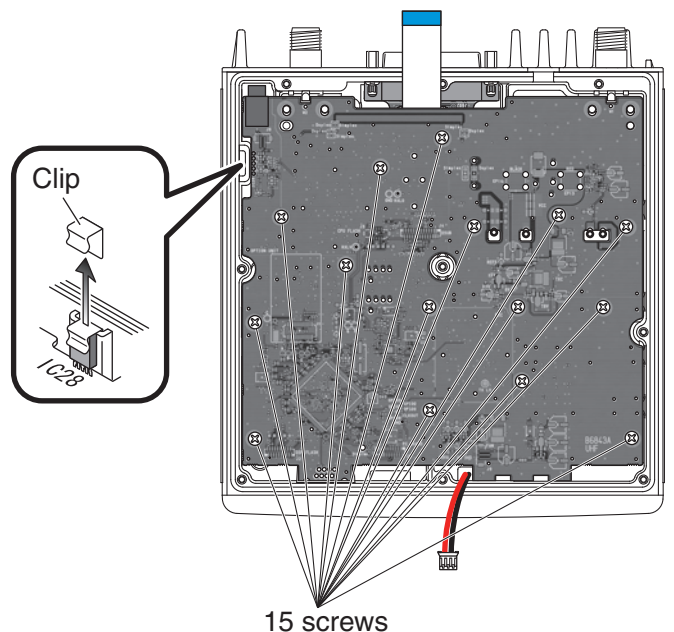

# SECTION 4 OPTIONAL UNIT INSTALLATION

Install UT-109R or UT-110R as follows.

- ① Disassembly the repeater until the MAIN UNIT is exposed. (see the page 3-1)
- ② Modify the patterns on the MAIN UNIT as below.

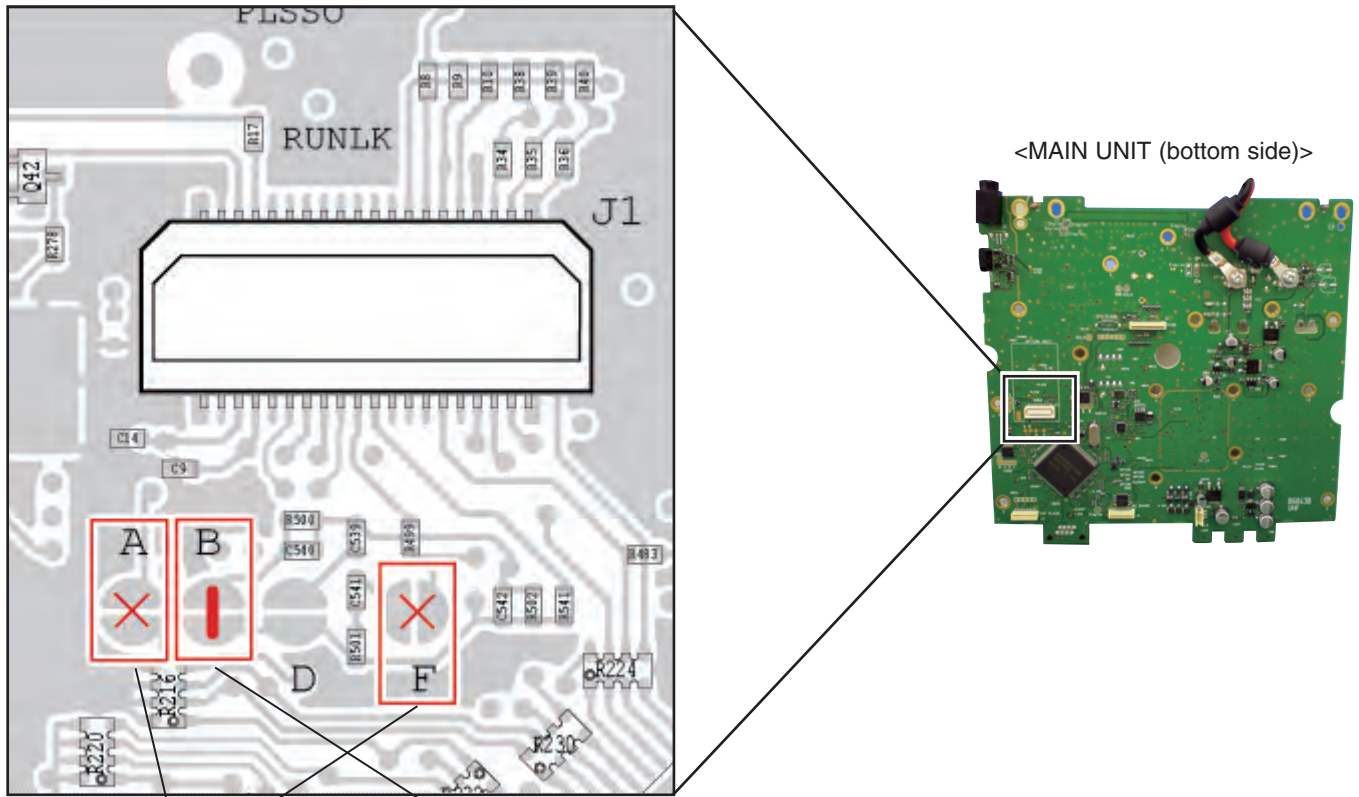

A and F; Cut the pattern

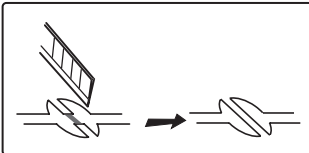

B; Short the pattern

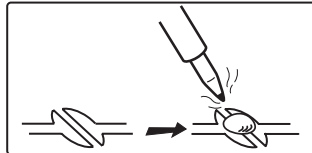

- ③ Remove the protective paper of optional unit, and install it to the J1 as below.

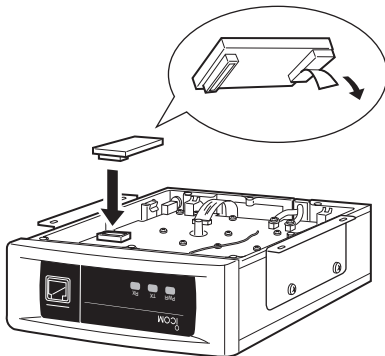

- ④ Replace the cover, screws, etc. to recover the whole assembly.

**NOTE: When uninstalling the scrambler unit**

Be sure to recover the disconnected or connected points, otherwise no TX modulation or AF output is available.



## 5-1 TRANSMITTER CIRCUITS

### TX PLL CIRCUIT

TX PLL IC (IC3) outputs resulting signal of phase-comparison of REF signal (15.3 MHz) and feedback OSC signal from TX VCO. The phase-difference signal is passed through the active loop filter (Q4, 10, 13) and applied to the TX VCO. The voltage of TX LV is adjusted to appropriate one. The OSC signal of TX VCO is FM-modulated by applied modulation signals.

### TX VCO CIRCUITS

There are 2 VCOs; VCO for band LOW (Q23, D10, 14, L19) and band HIGH (Q22, D9, 13, L18), and these VCO (=OSC freq.) are switched by the VCO SW (Q27, 28). The OSC frequencies of these VCO are adjusted (=Locked) by the TX LV signal (Lock Voltage). The modulation signals applied to the Variable Capacitor (VD; D17 or D18) vary the capacitor reactance of it for FM modulation. The output signals of these VCOs are applied to the power AMP circuits via buffers (Q24, 35).

A portion of these output signals are passed through the doubler (Q33) to extract 2nd harmonics, then applied to the PLL IC (IC3) via the LPF.

### YGR/PA CIRCUITS

The output signals from TX VCOs are amplified by pre-AMPs (Q37, 38), the amplified the PA module (IC22) to obtain required TX power. The power-amplified TX signals are passed through the ANT SW (D44) and LPF (for harmonics removal) then applied to the TX ANT.

### APC CIRCUIT

D45, D48 and D49 detect the TX power and the detected voltage are applied to the IC23 of APC circuit. Comparing the detected voltage (in proportion to TX power) and power setting voltage (as a reference voltage), IC23 adjusts the bias (pin 2: VGG) of PA module to control the TX power.

### MODULATION CIRCUITS

The audio signals from the Microphone (MIC signals) are applied to the MIC AMP (IC25). The amplified MIC signals are passed through the SW IC (IC35) which signal selects the source of MIC signals from J5 (from MIC) and from D-SUB connector (DEXM).

The MIC signals from the SW IC are amplified by an AMP (IC1) then applied to the LINEAR CODEC IC (IC8) where the MIC signals are converted in to the digital signals. The converted digital signals are processed (pre-emphasis, limit, etc.) by the DSP (IC12), then recovered to the analog audio signals. The AF signals are amplified by IC1 and level-adjusted by Ele.VR (IC2), then applied to the TX VCO and TCXO (X1) as the modulation signals.

### SIGNALING (ENCODE)

The Continuous Tone (CTCSS/DTCS), Single Tone (5-Tone/DTMF/CW\_ID) signals are encoded in the DSP (IC12), and mixed with MIC signals, level-adjusted by Ele. VR (IC2), then applied to the TX VCO and TCXO (X1) for modulation.

## 5-2 RECEIVER CIRCUITS

### RX PLL CIRCUIT

The RX PLL IC (IC4) outputs resulting signal of phase-comparison of REF signal from the TCXO (X2: 15.3 MHz) and feedback OSC signal from RX VCO. The phase-difference signal is passed through the active loop filter (Q6, 11, 14) and applied to the RX VCO. The voltage of RX LV (lock voltage) is adjusted to appropriate one by "RX LVA" signal.

A portion of reference frequency signal from the TCXO (X2: 15.3 MHz) is passed through the tripler (Q2) to extract 3rd harmonics, then applied to the IF IC (IC5).

### RX VCO

There are 2 VCOs; VCO for band LOW (Q21, D8, 16, L21) and band HIGH (Q20, D7, 15, L20), and these VCO (=OSC freq.) are switched by the VCO SW (Q26, 30). The OSC frequencies of these VCO are adjusted (=Locked) by the RX LV signal (Lock Voltage). The output signals of these VCOs are applied to the 1st mixer (L27, 32, D62) via buffers (Q25, 34) and LO AMP (Q65).

A portion of these output signals are passed through the buffer (Q25) doubler (Q32) to extract 2nd harmonics, then applied to the PLL IC (IC4) via the LPF.

### RF BPF CIRCUITS

RX signals from the RX ANT connector (J11) are passed through the 1st stage of BPF (D28, 29, 31, 32, L44, 47) then amplified by the RF AMP (Q36). The amplified RX signals are passed through the 2nd stage of BPF to remove unwanted signals for good image response then applied to the 1st mixer (L27, 32, D62).

Being mixed with 1st LO from the RX VCO, the RX signals are converted into the 46.35 MHz 1st IF signal. The 1st and 2nd stage of the BPF are tune to the pass band frequency by applying the tracking voltage "T1" and "T2" from the DAC (IC17). The gain of low noise RF AMP (Q36) is controlled by the AGC circuit (Q39, D27) according to the RX signal strength.

## **IF FILTER/IF AMP CIRCUITS**

The 1st IF signal from the 1st mixer (L27, 32, D62) is amplified by the post AMP (Q63, 64) and 1st stage of IF AMP (Q7) then filtered by crystal filter (F13 or F14), and then applied to the IF IC (IC5).

The crystal filters (F13 or F14) are switched by the "NWC 1" signal from the CPU (IC20) according to the RX mode; Wide (Middle), Narrow and Digital.

### **<ANALOG RX>**

Being mixed with the 2nd LO, the 1st IF signal is converted into the 450 kHz 2nd IF signal then detected by the internal quadrature detector (X3 as a discriminator) to demodulate. The demodulated AF signals are amplified by the AF AMP (IC36), and applied to the LINER CODEC (IC8). The AF signals are converted into the digital signal then processed by the DSP (IC12) then recovered to the analog audio signals.

The ceramic filters (F11 or F12) are switched by the "NWC2" signal from the CPU (IC20) according to the RX mode; Wide (Middle), Narrow and Digital.

### **<DIGITAL RX>**

The 450 kHz 2nd IF signal is amplified by IC7 then applied to the DSP (IC12) via ADC (IC9) and digital demodulated. The processed digital signal is converted into the analog audio signal by the LINEAR CODEC (IC8).

## **AF AMPLIFIER CIRCUITS**

The AF signals from the LINEAR CODEC are amplified by the AF AMP (IC36) and level-adjusted by DAC (IC2), then applied to IC28 via IC29 to be power-amplified.

## **SIGNALING (DECODE)**

The Continuous Tone (CTCSS/DTCS), Single Tone (5-Tone/DTMF/CW\_ID) signals in the demodulated AF signals are decoded in the DSP (IC8).

## **5-3 OTHER CIRCUITS**

### **POWER SUPPLY**

The power supply is switched by Q57 (ON/OFF). 5V (REF5) from the regulator (IC30) is passed through L58 to supply to CPU. The 5V also supplies to other sections of the repeater via Q41 as "+5V."

8V from the regulator (IC27) are supplies to various circuits, and also supplies to TX circuits as "T8V" and RX circuits as "8V."

5V from the regulator (IC39) supplies DSP as "DSP5" and supplies logic circuits; CPU, DSP, etc. via regulators (IC13, 14, 15).

The regulator "F8V" (IC41) provides the supply for FRONT UNIT.

### **COMPANDER**

The compander in the DSP (IC12) compresses the amplitude of MIC signals in TX, and expands in RX to provide high quality recovered sounds.

### **LED**

DS1 (BUSY), DS2(PWR) and DS3 (TX) indicate the repeater's status: Power ON, T/RX and Cloning.

## 5-4 CPU (M: IC20) PORT ALLOCATION

Pin No.	LINE NAME	DESCRIPTION	IN/OUT	CONDITION
140-144	D0-D4	DSP data bus line.	I/O	-
1-11	D5-D15	DSP data bus line.	I/O	-
15-28	A1-A14	DSP data bus line.	I/O	-
29	HRW	DSP data line.	I/O	-
32	FANS	Cooling fan (CH: MF1) rotation detect.	I	"H"=While the cooling fan is rotating.
33	TLED	TX indicator LED control signal.	O	"H"=TX
34	LEDR	RX indicator LED control signal.	O	"H"=Squelch open.
35	PLSCK	PLL (M: IC4) serial clock.	O	-
36	PLSSO	PLL (M:IC4) serial data.	O	-
41	PWON	Power line "VCC" control signal.	O	"H"=Power ON.
42	AFON2	AF power AMP. (M: IC28) control signal.	O	"H"=AF power AMP ON.
43	AFON	AF output select signal.	O	"H"=AF signals are output from the [ACCESSORY CONNECTOR].
44	ESCL	Serial clock to the EEPROM (M: IC21).	O	-
45	ESDA	Serial data to the EEPROM (M: IC21).	O	-
46	TXC	TX power line "T8V" control signal.	O	"H"=TX
47	RXC	RX power line "R8V" control signal.	O	"H"=RX
48	RPLST	RX PLL (M: IC4) strobe.	O	-
49	TPLST	TX PLL (M: IC3) strobe.	O	-
50	RUNLK	RX PLL (M: IC4) unlock signal.	I	"L"=Unlocked
51	TUNLK	TX PLL (M: IC3) unlock signal.	I	"L"=Unlocked
52	XCTS	Serial data from the RS-232 line driver (M: IC26).	I	-
53	XRTS	Serial data to the RS-232 line driver (M: IC26).	O	-
55	EXDA	External D/A port.	O	-
56	BEEP	Beep sounds (square waves).	O	-
57-59	OPV3-OPV1	Optional unit detect.	I	-
60	MMUT	MIC mute signal to the installed optional unit.	O	"H"=MIC mute
61	HANG	Microphone hang-up detect.	I	"L"=Hang-up
62	PTT	[PTT] key input. (pull up)	I	-
63	RMUT	RX mute signal to the installed optional unit.	O	"H"=RX mute
64	EXAD	External A/D port.	I	-
65	TEMP	Temperature detect.	I	-
68	RLVIN	RX PLL lock voltage.	I	-
69	BATV	Voltage monitor (divided voltage of "VCC").	I	-
70	TLVIN	TX PLL lock voltage.	I	-
71	RSSI	RSSI signal from the IF IC (M: 5).	I	-
74	XTXD	External data to the RS-232 driver (M: IC26).	O	-
75	XRXD	External data from the RS-232 driver (M: IC26).	I	-
76	TMUT	TX mute signal.	O	"H"=TX mute
77	HINT	DSP IC control signal.	O	-
78	INT1	DSP IC control signal.	O	-
79	HRDY	DSP IC control signal.	O	-
81	HDS1	DSP IC control signal.	O	-
82	HDS2	DSP IC control signal.	O	-
100	RES	CPU reset signal from the reset IC (F: IC501).	O	-
101-108	EXIO1-EXIO8	External data bus line.	I/O	+5 V pull-up
112	POSW	[PWR] key input. (pull-up)	I	-
113	NOIS	Noise detect.	I	"H"=RX signal is absent (squelch close).
114	CSFT	Clock frequency shift signal.	O	-
119	SSO	Serial data to the seri-para converter (M: IC31).	O	-
120	SCK	Clock signal to the seri-para converter (M: IC31).	O	-
121	EXIO9	External data bus line.	I/O	+5 V pull-up
122	DSDA	Serial data to the DAC (M: IC17).	O	-

**3-4 CPU (M: IC20) PORT ALLOCATION (continued)**

Pin No.	LINE NAME	DESCRIPTION	IN/OUT	CONDITION
123	DAST	Strobe to the DAC (M: IC2).	O	-
125	FMDA	Data from the FRONT CPU (F: IC502).	I	-
126	MFDA	Data to the FRONT CPU (F: IC502).	O	-
127	OPT2	Port for optional unit.	O	-
128	OPT1	Port for optional unit.	I	-
129	OPT3	Port for optional unit.	I	-
131	CSO	Port for optional unit.	O	-
132	CSI	Port for optional unit.	I	-
133	EXOE	Output enable signal to the seri-para converter (M: IC31).	O	-
134	EXST	Strobe to the seri-para converter (M: IC31).	O	-
135	DRES	Reset signal to the DSP IC (M: IC12).	O	-
136	HCS	DSP data line.	I/O	-
138	GPIO2	DSP data line.	I/O	-
139	GPIO1	DSP data line.	I/O	-



# SECTION 6 ADJUSTMENT PROCEDURE

## 6-1 PREPARATION

### ■ REQUIRED EQUIPMENTS

EQUIPMENT	SPECIFICATION	EQUIPMENT	SPECIFICATION
Adjustment Software	"CS-FR5000" (Revision 1.0 or later)	JIG cable	Modified OPC-1122U (USB type) (see the illust below)
Power Supply	Output voltage : 13.6 V DC [UR-FR6000] 13.2 V DC [UR-FR6100] Current capacity : More than 20 A [UR-FR6000] More than 10 A [UR-FR6100]	Attenuator	Power attenuation : 40 dB Capacity : More than 60 W [UR-FR6000] More than 30 W [UR-FR6100]
RF Power Meter (terminated type)	Measuring range : 1–60 W [UR-FR6000] 1–30 W [UR-FR6100] Frequency range : 100–600 MHz Impedance : 50 Ω SWR : Less than 1.2 : 1	Standard Signal Generator (SSG)	Frequency range : 0.1–600 MHz Output level : 0.1 mV to 32 mV (–127 to –17 dBm)
Frequency Counter	Frequency range : 0.1–600 MHz Frequency accuracy : ±1 ppm or better Input level : Less than 1 mW	Audio Generator	Frequency range : 300–3000 Hz Output level : 1–500 mV
Modulation Analyzer	Frequency range : 30–600 MHz Measuring range : 0 to ±10 kHz	AC Millivoltmeter	Measuring range : 10 mV to 10 V
		Oscilloscope	Frequency range : DC–20 MHz Measuring range : 0.01–20 V
		External Speaker	Input impedance : 4 Ω Capacity : More than 5 W

### ■ JIG CABLE

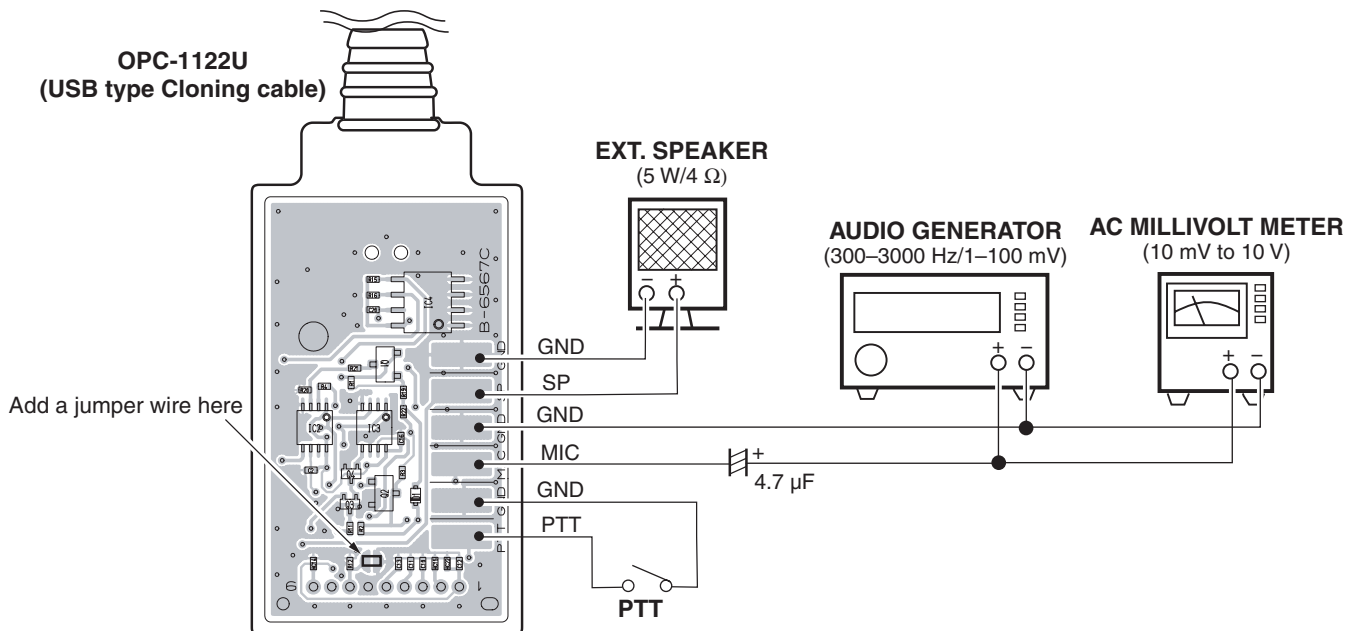

## CONNECTION

**NOTE:** Installing your UR-FR6000/UR-FR6100 into an IC-FR6000/IC-FR6100 is necessary for adjustment.

### FRONT VIEW

Turn the extended module's power ON  
(see the IC-FR6000/IC-FR6100 Instruction Manual)

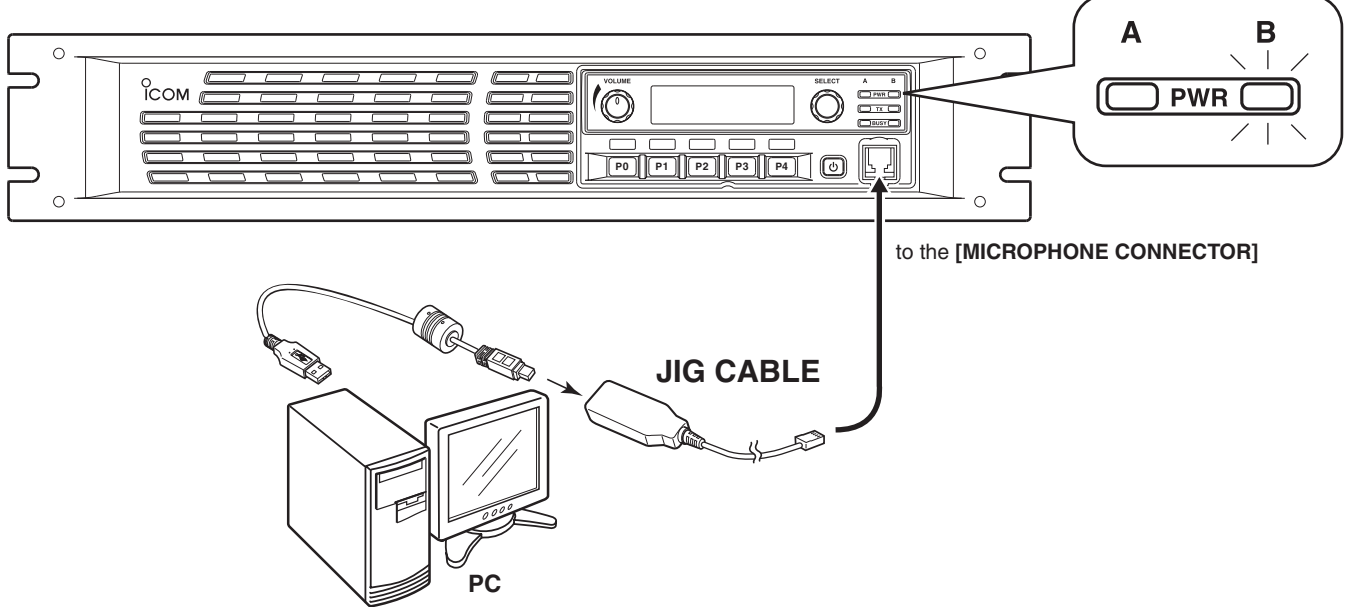

### REAR VIEW

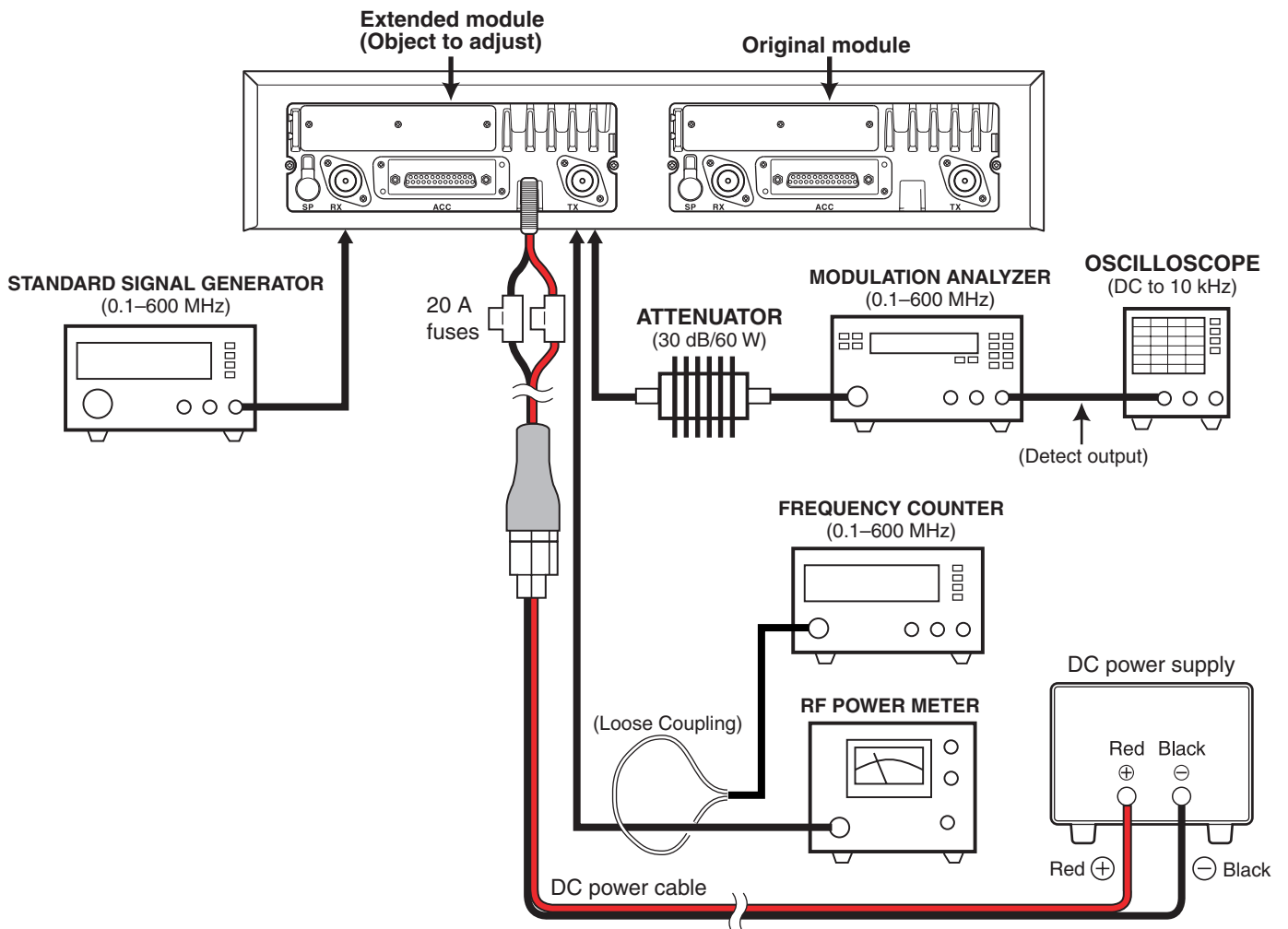

## ADJUSTMENT CHANNEL LISTS

Clone the adjust channels into the repeater before starting adjustment. Each channel must be assigned [Frequency], [RF PWR], [CH Type], [TX C. Tone] and [W/N] as below.

### • Channel list for [Low band] version

CH	Atr	Inh	Operation Mode	Frequency (MHz)			Text	TOT			RF PWR	Lock-out	to an	CH Type	Au Res	FM	
				RX	TX	TX Inh		Local Mic	Repeat/EPTT	TX C.Tone						W/N	
1- 1	AB		Simplex	400.100000	<-		LV L ADJ				L1		Analog	Tim		W	
1- 2			Simplex	435.100000	<-		LV H ADJ				L1		Analog	Tim		W	
1- 3			Simplex	434.950000	<-		LV L VRFY				L1		Analog	Tim		W	
1- 4			Simplex	469.900000	<-		LV H VRFY				L1		Analog	Tim		W	
1- 5			Simplex	469.900000	<-		TX Freq				L1		Analog	Tim		W	
1- 6			Simplex	400.100000	<-		TX PWR Hi				H		Analog	Tim		W	
1- 7			Simplex	400.100000	<-		TX PWR L2				L2		Analog	Tim		W	
1- 8			Simplex	400.100000	<-		TX PWR L1				L1		Analog	Tim		W	
1- 9			Simplex	400.100000	<-		BAL				L1		Analog	Tim		W	
1- 10			Simplex	435.100000	<-		BAL Offset				L1		Analog	Tim		W	
1- 11			Simplex	400.100000	<-		DG Dev.				L1		Digital	Tim	----	-	
1- 12			Simplex	411.500000	<-		DG Dev. 0				L1		Digital	Tim	----	-	
1- 13			Simplex	423.200000	<-		DG Dev. 1				L1		Digital	Tim	----	-	
1- 14			Simplex	434.900000	<-		DG Dev. 2				L1		Digital	Tim	----	-	
1- 15			Simplex	435.100000	<-		DG Dev. Offs				L1		Digital	Tim	----	-	
1- 16			Simplex	446.600000	<-		DG Dev. 3				L1		Digital	Tim	----	-	
1- 17			Simplex	458.300000	<-		DG Dev. 4				L1		Digital	Tim	----	-	
1- 18			Simplex	469.900000	<-		DG Dev. 5				L1		Digital	Tim	----	-	
1- 19			Simplex	400.100000	<-		AN Dev. W				L1		Analog	Tim		W	
1- 20			Simplex	400.100000	<-		AN Dev. M				L1		Analog	Tim		W	
1- 21			Simplex	400.100000	<-		AN Dev. N				L1		Analog	Tim		N	
1- 22			Simplex	400.100000	<-		CT/DT Dev.				L1		Analog	Tim	151.4	W	
1- 23			Simplex	400.100000	<-	i	BPF C T2				L1		Analog	Tim		W	
1- 24			Simplex	469.900000	<-	i	BPF H ALL				L1		Analog	Tim		W	
1- 25			Simplex	400.100000	<-	i	RSSI				L1		Analog	Tim		W	
1- 26			Simplex	400.100000	<-	i	SQL				L1		Analog	Tim		W	

### • Channel list for [High band] version

CH	Atr	Inh	Operation Mode	Frequency (MHz)			Text	TOT			RF PWR	Lock-out	to an	CH Type	Au Res	FM	
				RX	TX	TX Inh		Local Mic	Repeat/EPTT	TX C.Tone						W/N	
1- 1	AB		Simplex	450.100000	<-		LV L ADJ				L1		Analog	Tim		W	
1- 2			Simplex	485.100000	<-		LV H ADJ				L1		Analog	Tim		W	
1- 3			Simplex	484.950000	<-		LV L VRFY				L1		Analog	Tim		W	
1- 4			Simplex	519.900000	<-		LV H VRFY				L1		Analog	Tim		W	
1- 5			Simplex	519.900000	<-		TX Freq				L1		Analog	Tim		W	
1- 6			Simplex	450.100000	<-		TX PWR Hi				H		Analog	Tim		W	
1- 7			Simplex	450.100000	<-		TX PWR L2				L2		Analog	Tim		W	
1- 8			Simplex	450.100000	<-		TX PWR L1				L1		Analog	Tim		W	
1- 9			Simplex	450.100000	<-		BAL				L1		Analog	Tim		W	
1- 10			Simplex	485.100000	<-		BAL Offset				L1		Analog	Tim		W	
1- 11			Simplex	450.100000	<-		DG Dev.				L1		Digital	Tim	----	-	
1- 12			Simplex	461.500000	<-		DG Dev. 0				L1		Digital	Tim	----	-	
1- 13			Simplex	473.200000	<-		DG Dev. 1				L1		Digital	Tim	----	-	
1- 14			Simplex	484.900000	<-		DG Dev. 2				L1		Digital	Tim	----	-	
1- 15			Simplex	485.100000	<-		DG Dev. Offs				L1		Digital	Tim	----	-	
1- 16			Simplex	496.600000	<-		DG Dev. 3				L1		Digital	Tim	----	-	
1- 17			Simplex	508.300000	<-		DG Dev. 4				L1		Digital	Tim	----	-	
1- 18			Simplex	519.900000	<-		DG Dev. 5				L1		Digital	Tim	----	-	
1- 19			Simplex	450.100000	<-		AN Dev. W				L1		Analog	Tim		W	
1- 20			Simplex	450.100000	<-		AN Dev. M				L1		Analog	Tim		W	
1- 21			Simplex	450.100000	<-		AN Dev. N				L1		Analog	Tim		N	
1- 22			Simplex	450.100000	<-		CT/DT Dev.				L1		Analog	Tim	151.4	W	
1- 23			Simplex	450.100000	<-	i	BPF C T2				L1		Analog	Tim		W	
1- 24			Simplex	519.900000	<-	i	BPF H ALL				L1		Analog	Tim		W	
1- 25			Simplex	450.100000	<-	i	RSSI				L1		Analog	Tim		W	
1- 26			Simplex	450.100000	<-	i	SQL				L1		Analog	Tim		W	

## WHOLE PROCEDURE OF THE ADJUSTMENT

- ① Connect the repeater and PC with the JIG cable (see the page 6-2).
- ② Turn the repeater power ON.
- ③ Boot up 'CS-FR5000.'
- ④ Set the [Digital Function] to "Enable."

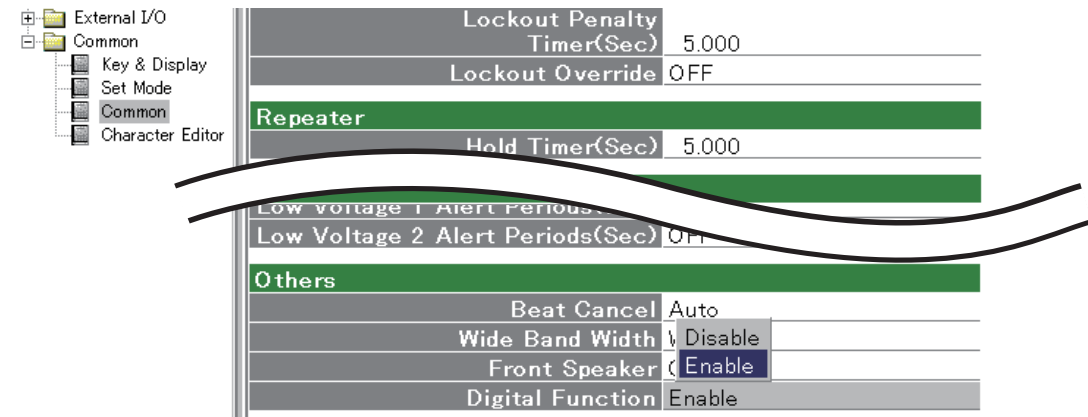

- ④ Click  or [Read ← TR] in the [Adjust] menu, then the "Adjust Utility" window (see the page 6-5) appears.

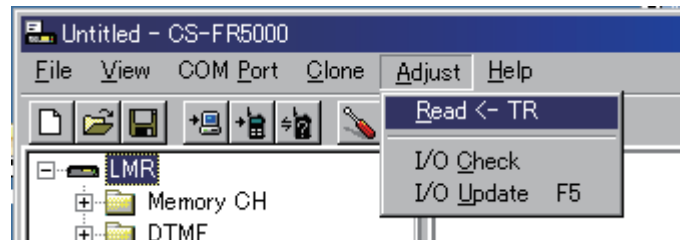

- ⑤ Set or modify adjustment values as specified in the guidances on the pages 6-6 to 6-9.

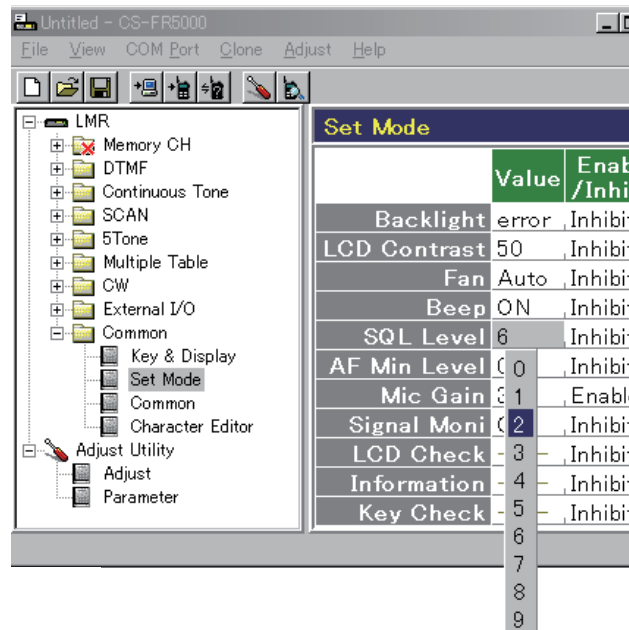

### \*For [UR-FR6100]:

Set the [Wide Band Width] to "Middle" when adjust "ANALOG DEVIATION" in Middle mode.

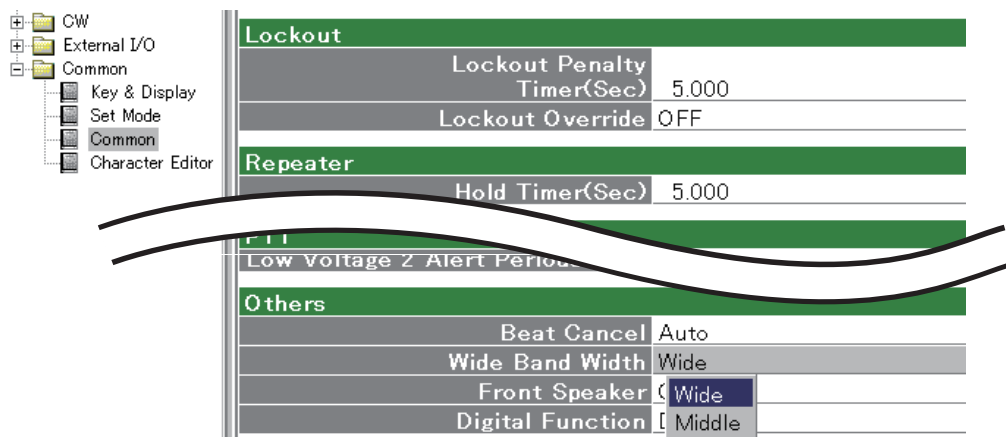



# ADJUST UTILITY WINDOW

Adjust Utility				
Setting				
	CH No.	1	Receive Sim	
	RX Freq.		451.10000MHz	
	TX Freq.		452.10000MHz	
	RF Power.		Low	
	W/N		Wide	
	CH Type		RX=Digital TX=Digital	
Mode setting	TX Mode	17	Digital PNB	
	RX Mode	2	Digital	
	AF Volume	0	[-----]	
Adjust				
TX output power	Power (H)	208	[-----]	
	Power (L2)	150	[-----]	
	Power (L1)	76	[-----]	
Analog deviation	MOD (Wide)	139	[-----]	
	MOD (Mid)	144	[-----]	
	MOD (Narrow)	65	[-----]	
	MOD (Digital)	105	[-----]	
CTCSS/DTCS deviation	CTCSS/DTCS	137	[-----]	
	S.Tone	75	[-----]	
Squelch	SQL	50	[-----]	
Expert				
TX frequency	RX REF	178	[-----]	
	TX REF	126	[-----]	
Lock volatge (Preset)	RX LVA L	80	[-----] [Enter] to Sweep	
	RX LVA H	62	[-----] [Enter] to Sweep	
	TX LVA L	166	[-----] [Enter] to Sweep	
	TX LVA H	105	[-----] [Enter] to Sweep	
Lock volatge (Adjustment)	LV (RX L)	36	0.70V	
	LV (RX H)	36	0.70V	
	LV (TX L)	36	0.70V	
	LV (TX H)	36	0.70V	
S-meter	RSSI	74	[Enter] to Capture	
Modulation balance	BAL	174	[-----]	
	BAL Offset (High)	0	[-----]	
Modulation balance (High)	PWR Hi Slant Band 0	0	[-----] 399.900000 - 411.599999 MHz	
	PWR Hi Slant Band 1	3	[-----] 411.600000 - 423.299999 MHz	
	PWR Hi Slant Band 2	4	[-----] 423.300000 - 434.999999 MHz	
	PWR Hi Slant Band 3	25	[-----] 435.000000 - 446.699999 MHz	
	PWR Hi Slant Band 4	8	[-----] 446.700000 - 458.399999 MHz	
	PWR Hi Slant Band 5	6	[-----] 458.400000 - 470.099999 MHz	
	PWR Hi Slant Band 6	0	[-----] 470.100000 - 481.799999 MHz	
	PWR L2 Slant Band 0	0	[-----] 399.900000 - 411.599999 MHz	
	PWR L2 Slant Band 1	4	[-----] 411.600000 - 423.299999 MHz	
	PWR L2 Slant Band 2	4	[-----] 423.300000 - 434.999999 MHz	
	PWR L2 Slant Band 3	17	[-----] 435.000000 - 446.699999 MHz	
	PWR L2 Slant Band 4	8	[-----] 446.700000 - 458.399999 MHz	
	PWR L2 Slant Band 5	6	[-----] 458.400000 - 470.099999 MHz	
	PWR L2 Slant Band 6	0	[-----] 470.100000 - 481.799999 MHz	
	PWR L1 Slant Band 0	0	[-----] 399.900000 - 411.599999 MHz	
	PWR L1 Slant Band 1	0	[-----] 411.600000 - 423.299999 MHz	
	PWR L1 Slant Band 2	2	[-----] 423.300000 - 434.999999 MHz	
	PWR L1 Slant Band 3	14	[-----] 435.000000 - 446.699999 MHz	
PWR L1 Slant Band 4	6	[-----] 446.700000 - 458.399999 MHz		
PWR L1 Slant Band 5	4	[-----] 458.400000 - 470.099999 MHz		
PWR L1 Slant Band 6	0	[-----] 470.100000 - 481.799999 MHz		
Digital deviation	MOD Slant Band 0	0	[-----] 399.900000 - 411.599999 MHz	
	MOD Slant Band 1	-9	[-----] 411.600000 - 423.299999 MHz	
	MOD Slant Band 2	-13	[-----] 423.300000 - 434.999999 MHz	
	MOD Slant Band 3	-2	[-----] 435.000000 - 446.699999 MHz	
	MOD Slant Band 4	-5	[-----] 446.700000 - 458.399999 MHz	
	MOD Slant Band 5	2	[-----] 458.400000 - 470.099999 MHz	
	MOD Slant Band 6	0	[-----] 470.100000 - 481.799999 MHz	
	MOD Offset (High)	0	[-----]	
*2Receive sensitivity (Band center)	BPF C ALL		[Enter] to Sweep	
	*1Receive sensitivity preset	BPF T1 C	4 [-----] [Enter] to Sweep	
	*1Receive sensitivity (Band center)	BPF T2 C	25	[-----] [Enter] to Sweep
		BPF L ALL		[Enter] to Sweep
	Receive sensitivity (Band high)	BPF T1 L	80	[-----] [Enter] to Sweep
		BPF T2 L	45	[-----] [Enter] to Sweep
		BPF H ALL		[Enter] to Sweep
		BPF T1 H	69	[-----] [Enter] to Sweep
BPF T2 H		53	[-----] [Enter] to Sweep	

\*1[Low band] only  
\*2[High band] only

## 6-2 FREQUENCY ADJUSTMENT

- 1) Select an adjustment item using cursor or [↑] / [↓] keys of the PC's keyboard.
- 2) Set or modify the adjustment value as specified using [←] / [→] keys of the PC's keyboard, then push the [ENTER] key.

ADJUSTMENT	ADJUSTMENT CONDITION	OPERATION	ADJUSTMENT ITEM	VALUE
PLL LOCK VOLTAGE -Preparation-	1	-	[LV (RX L)] [LV (RX H)] [LV (TX L)] [LV (TX H)]	36 [0.70V] (for each item)
-Adjust-RX (Band low)	2	• CH. : 1-1 • Receiving	[RX LVA L]	(Automatic adjustment)
RX (Band high)	3	• CH. : 1-2 • Receiving	[RX LVA H]	
TX (Band low)	4	• CH. : 1-1 • Transmitting	[TX LVA L]	
TX (Band high)	5	• CH. : 1-2 • Transmitting	[TX LVA H]	
LOCK VOLTAGE VERIFY	1	• CH. : 1-3 • Receiving	[RX LIVIN] (I/O Check window)	3.0–4.3 V (Verify)
RX (Band low)	2	• CH. : 1-4 • Receiving		3.0–4.0 V (Verify)
RX (Band high)	3	• CH. : 1-3 • Transmitting	[TX LIVIN] (I/O Check window)	2.7–4.0 V (Verify)
TX (Band low)	4	• CH. : 1-4 • Transmitting		3.0–4.2 V (Verify)
TX (Band high)	1	-	[TX Mode]	"1"
TX FREQUENCY	2	• CH. : 1-5 • Transmitting	[TX REF]	469.9000 MHz [Low band] 519.9000 MHz [High band]

### • I/O CHECK WINDOW

I/O Check			
Input	Dec	Hex	Data
VIN	180	B4	14.12V
TEMPS	108	06	28.21°C
RX LVIN	116	74	2.27V
TX LVIN	219	DB	4.29V
SD	28	1C	0.55V
Output			
	Dec	Hex	Data
BPF T1	165	A5	3.24V
BPF T2	253	FD	4.96V
RF POWER	0	0	0.00V
RX LVA	165	A5	3.24V
TX LVA	145	91	2.84V
RX REF	77	4D	1.51V
TX REF	126	7E	2.47V
MOD BAL	0	0	0.00V
DEV	43	2B	0.84V
FANV	255	FF	5.00V

Lock voltage verify

## 6-3 TRANSMIT ADJUSTMENT

1) Select an adjustment item using cursor or [↑] / [↓] keys of the PC's keyboard.

2) Set or modify the adjustment value as specified using [←] / [→] keys of the PC's keyboard, then push the [ENTER] key.

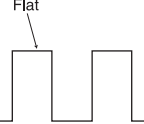
ADJUSTMENT		ADJUSTMENT CONDITION	OPERATION	ADJUSTMENT ITEM	VALUE
<b>TX Output Power</b> -Preparation-	1	—	• Connect an RF power meter to the TX antenna connector.	—	—
-Adjust- (Hi Power)	2	• CH. : 1-6 • Transmitting	1) Adjust the TX output power using [←] / [→] keys of the PC's keyboard. 2) Push the [ENTER] key to store the adjust value.	[Power(Hi)]	50 W [UR-FR6000] 25 W [UR-FR6100]
(L2 Power)	3	• CH. : 1-7 • Transmitting		[Power(L2)]	25 W [UR-FR6000] 10 W [UR-FR6100]
(L1 Power)	4	• CH. : 1-8 • Transmitting		[Power(L1)]	5 W [UR-FR6000] 2.5 W [UR-FR6100]
<b>MODULATION BALANCE</b> -Preparation-	1	• Connect a Modulation Analyzer to the TX antenna connector through an attenuator.	• Set the Modulation Analyzer as; HPF : OFF LPF : 20 kHz De-emphasis : OFF Detector : (P-P)/2	—	—
	2	• Connect an Audio Generator to the MIC line through the JIG cable.	• Set the Audio Generator as; Modulation : 1 kHz Level : 40 mV rms Wave form : Sine wave	—	—
	3	—	• Set the item [TX Mode] to "2."	[TX Mode]	"2"
-Adjust- (VCO 1)	4	• CH. : 1-9 • Transmitting	1) Adjust the wave form using [←] / [→] keys of the PC's keyboard. 2) Push the [ENTER] key to store the adjust value.	[BAL]	(square wave form)
(VCO 2)	5	• CH. : 1-10 • Transmitting		[BAL Offset (High)]	
<b>DIGITAL DEVIATION</b> -Preparation-	1	—	• Set the item [TX Mode] to "16."	[TX Mode]	"16"
	2	• Connect a Modulation Analyzer to the TX antenna connector through an attenuator.	• Set the Modulation Analyzer as; HPF : OFF LPF : 20 kHz De-emphasis : OFF Detector : (P-P)/2	—	—
-Adjust- (Band 1)	3	• CH. : 1-11 • Transmitting	1) Adjust the deviation using [←] / [→] keys of the PC's keyboard. 2) Push the [ENTER] key to store the adjust value.	[MOD (Digital)]	±1.39–1.43 kHz
(Band 2)	4	• CH. : 1-12 • Transmitting		[MOD Slant Band 0]	
(Band 3)	5	• CH. : 1-13 • Transmitting		[MOD Slant Band 1]	
(Band 4)	6	• CH. : 1-14 • Transmitting		[MOD Slant Band 2]	
(Band 5)	7	• CH. : 1-15 • Transmitting		[MOD Offset (High)]	
(Band 6)	8	• CH. : 1-16 • Transmitting		[MOD Slant Band 3]	
(Band 7)	9	• CH. : 1-17 • Transmitting		[MOD Slant Band 4]	
(Band 8)	10	• CH. : 1-18 • Transmitting		[MOD Slant Band 5]	

### 6-3 TRANSMIT ADJUSTMENT (continued)

- 1) Select an adjustment item using cursor or [↑] / [↓] keys of the PC's keyboard.
- 2) Set or modify the adjustment value as specified using [←] / [→] keys of the PC's keyboard, then push the [ENTER] key.

ADJUSTMENT	ADJUSTMENT CONDITION	OPERATION	ADJUSTMENT ITEM	VALUE
<b>ANALOG DEVIATION</b> <b>-Preparation-</b>	1	–	• Set the item [TX Mode] to "1."	[TX Mode] "1"
	2	• Connect a Modulation Analyzer to the TX antenna connector through an attenuator.	• Set the Modulation Analyzer as; HPF : OFF LPF : 20 kHz De-emphasis : OFF Detector : (P-P)/2	– –
	3	• Connect an Audio Generator to the MIC line through the JIG cable.	• Set the Audio Generator as; Modulation : 1 kHz Level : 40 mV rms Wave form : Sine wave	– –
<b>-Adjust-</b> <b>(Wide)</b>	4	• CH. : 1-10 • Transmitting	1) Adjust the deviation using [←] / [→] keys of the PC's keyboard. 2) Push the [ENTER] key to store the adjust value.	[MOD (Wide)] ±4.05–4.15 kHz
<b>(Middle)</b> <b>&lt;[UR-FR6100] only&gt;</b>	5	• CH. : 1-11 • [Wide Band Width] : "Middle" (see the page 6-4) • Transmitting		[MOD (Middle)] ±3.15–3.25 kHz
<b>(Narrow)</b>	6	• CH. : 1-12 • Transmitting		[MOD (Narrow)] ±2.05–2.15 kHz
<b>CTCSS/DTCSS DEVIATION</b> <b>-Preparation-</b>	1	–	• Set the item [TX Mode] to "3."	[TX Mode] "3"
<b>-Adjust-</b>	2	• CH. : 1-19 • Transmitting	1) Adjust the deviation using [←] / [→] keys of the PC's keyboard. 2) Push the [ENTER] key to store the adjust value.	[CTCSS] ±0.68–0.72 kHz

### 6-4 RECEIVE ADJUSTMENT

- 1) Select an adjustment item using cursor or [↑] / [↓] keys of the PC's keyboard.
- 2) Set or modify the adjustment value as specified using [←] / [→] keys of the PC's keyboard, then push the [ENTER] key.

ADJUSTMENT	ADJUSTMENT CONDITION	OPERATION	ADJUSTMENT ITEM/POINT	VALUE
<b>RECEIVE SENSITIVITY</b> <b>-Preparation-</b>	1	–	• Set the item [RX Mode] to "1."	[RX Mode] "1"
	2	• Connect an SSG to the RX antenna connector.	• Set the SSG as; Frequency : 400.100 MHz [UR-FR6000] 450.100 MHz [UR-FR6100] Level : +20 dBμ Modulation : 1 kHz Deviation : 3.5 kHz	– –
<b>-Adjust-</b> <b>(Band center)</b> <b>For [Low band] version</b>	3	• CH. : 1-20 • Receiving	1) Set the item [BPFT1 C] to "10." 2) Select the item [BPF T2 C], then push the [ENTER] key.	[BPFT1 C] "10"
			[BPF T2 C]	(Automatic adjustment)
<b>-Adjust-</b> <b>(Band center)</b> <b>For [High band] version</b>		• CH. : 1-20 • Receiving	• Select the item [BPF C ALL], then push the [ENTER] key.	
<b>(Band high)</b>	4	• CH. : 1-21 • Receiving	• Select the item [BPF H ALL], then push the [ENTER] key.	[BPF H ALL]



**6-4 RECEIVE ADJUSTMENT (continued)**

1) Select an adjustment item using cursor or [↑] / [↓] keys of the PC's keyboard.

2) Set or modify the adjustment value as specified using [←] / [→] keys of the PC's keyboard, then push the [ENTER] key.

ADJUSTMENT	ADJUSTMENT CONDITION	OPERATION	ADJUSTMENT ITEM/POINT	VALUE	
<b>S-METER</b> <b>-Preparation-</b>	<b>NOTE:</b> "RECEIVE SENSITIVITY" MUST be adjusted before "S-METER." When "RECEIVE SENSITIVITY" is re-adjusted, "S-METER" MUST be re-adjusted too.				
	1	<ul style="list-style-type: none"> <li>• Connect an SSG to the RX antenna connector.</li> </ul>	<ul style="list-style-type: none"> <li>• Set the SSG as;                      Frequency : 400.100 MHz [Low band]                      450.100 MHz [High band]                      Modulation : 1 kHz                      Deviation : 3.5 kHz</li> </ul>	-	-
<b>-Adjust-</b> <b>(S3 level)</b>	2	<ul style="list-style-type: none"> <li>• CH. : 1-22</li> <li>• Receiving</li> </ul>	1) Set the SSG as; Level : +23 dB $\mu$ 2) Select the item <b>[RSSI S3 Level]</b> , then push the [ENTER] key to store the adjust value.	<b>[RSSI S3 Level]</b>	(Automatic adjustment)
<b>(S1 level)</b>	3	<ul style="list-style-type: none"> <li>• CH. : 1-22</li> <li>• Receiving</li> </ul>	1) Set the SSG as; Level : -7 dB $\mu$ 2) Select the item <b>[RSSI S1 Level]</b> , then push the [ENTER] key, to store the adjust value.	<b>[RSSI S1 Level]</b>	(Automatic adjustment)
<b>SQUELCH</b> <b>-Preparation-</b>	1	-	<ul style="list-style-type: none"> <li>• Set the item <b>[SQL Level]</b> to "2."</li> </ul>	<b>[SQL Level]</b>	"2"
	2	<ul style="list-style-type: none"> <li>• Connect an SSG to the RX antenna connector.</li> </ul>	<ul style="list-style-type: none"> <li>• Set the SSG as;                      Frequency : 400.100 MHz [Low band]                      450.100 MHz [High band]                      Modulation : 1 kHz                      Deviation : 3.5 kHz                      Level : -14 dB<math>\mu</math></li> </ul>	-	-
<b>-Adjust-</b>	2	<ul style="list-style-type: none"> <li>• CH. : 1-23</li> <li>• Receiving</li> </ul>	1) Decrease the adjustment value <b>[SQL]</b> to close the squelch once, then increase the value to open the squelch. 2) Select the item <b>[SQL]</b> , then push the [ENTER] key to store the adjust value.	<b>[SQL]</b>	(Automatic adjustment)

## SECTION 7

## PARTS LIST

## [MAIN UNIT]

REF NO.	ORDER NO.	DESCRIPTION	M.	H/V LOCATION
IC1	1110005330	S.IC NJM12904V-TE1-#ZZZB	T	58.1/71.4
IC2	1110007290	S.IC AK2330P-L	T	58.7/56.1
IC3	1130010100	S.IC LMX2352TMX/NOBP	B	120.2/43.9
IC4	1130010100	S.IC LMX2352TMX/NOBP	B	28/78.8
IC5	1110003491	S.IC TA31136FNG (D,EL)	B	70.4/82.5
IC7	1110007280	S.IC NJM2716F-TE1-#ZZZB	B	56.8/46.4
IC8	1130012910	S.IC AK4554VTP-E2/P	B	36.2/59.9
IC9	1190002080	S.IC AD7476ARTZ-500RL7	B	49.6/46.4
IC10	1130013040	S.IC TC7WBD125AFK (T5L,F)	B	46.6/49.2
IC11	1110006230	S.IC NJM2711F-TE1-#ZZZB	B	53.1/35
IC12	1140013290	S.IC TMS320VC5509AZHH	B	33.3/37.8
IC13	1180002590	S.REG XC6204B332MR	T	80.9/21.3
IC14	1180003270	S.REG R1114Q161D-TR-F	T	84.4/21.4
IC15	1180002590	S.REG XC6204B332MR	T	87.8/21.3
IC17	1190001340	S.IC M62334FP 600C	T	67.3/61.7
IC18	1110005771	S.IC S-80942CNMC-G9CT2G	T	41.2/52.8
IC20	1140014550	S.IC HD64F2506RFC26VD	T	33.5/37.6
IC21	1140012950	S.IC 24LC512T-I/SM	T	59.1/21.8
IC22	1150002092	RA30H4047M-121 [EUR-01]		
	1150002211	IC RA55H4047M-121 [USA-01], [EXP-01]		
IC22	1150002221	IC RA55H4452M-121 [High band]		
IC23	1110002751	S.IC TA75S01F (TE85R,F)	T	139.3/125.6
IC25	1130008561	S.IC TC75S51F (TE85L,F)	B	29/16.3
IC26	1120003070	S.IC MAX3232EIPWR	T	42.7/70
IC27	1180001251	S.IC TA7808F (TE16L,Q)	T	116.6/84.1
IC28	1110003091	IC LA4425A-E		
IC29	1110002751	S.IC TA75S01F (TE85R,F)	T	12/123.1
IC30	1110003390	S.IC AN8005M-(E1)	T	114.1/91.8
IC31	1130011760	S.IC CD4094BPWR	T	8.1/45.2
IC32	1130013360	S.IC AT25F2048N-10SU-2.7SL383	B	8.9/36.1
IC34	1110005340	S.IC NJM12902V-TE1-#ZZZB	B	12.2/58.2
IC35	1140013200	S.IC CD4053BPWR	B	20.6/58.2
IC36	1110005330	S.IC NJM12904V-TE1-#ZZZB	B	27.8/55.4
IC37	1120002830	S.IC NJM125F-TE1-#FZZB	T	56.6/66.7
IC38	1110006380	S.IC LM2904PWR	T	114.1/23.8
IC39	1180001071	S.IC TA7805F (TE16L,Q)	T	101.2/24.3
IC40	1110005330	S.IC NJM12904V-TE1-#ZZZB	B	50.6/57.2
IC41	1180001251	S.IC TA7808F (TE16L,Q)	B	132/16.7
Q1	1590003230	S.TR UNR9113J-(TX)	B	53.4/79.7
Q2	1530002851	S.TR 2SC4116-BL (TE85R,F)	B	34.9/77.7
Q3	1560001360	S.FET 2SK3019 TL	B	66.4/76.6
Q4	1560000541	S.FET 2SK880-Y (T5RICOM,F)	B	88.8/41.5
Q5	1560000541	S.FET 2SK880-Y (T5RICOM,F)	B	33.3/107.5
Q6	1560000541	S.FET 2SK880-Y (T5RICOM,F)	B	29.6/101.3
Q7	1530002601	S.FET 2SC4215-O (TE85R,F)	B	72.9/92.5
Q8	1560000541	S.FET 2SK880-Y (T5RICOM,F)	B	92.7/47.7
Q9	1560001360	S.FET 2SK3019 TL	B	39.5/104.5
Q10	1530002851	S.TR 2SC4116-BL (TE85R,F)	B	88.8/44.6
Q11	1530002851	S.TR 2SC4116-BL (TE85R,F)	B	29.6/104.4
Q12	1590003230	S.TR UNR9113J-(TX)	B	65.6/101.6
Q13	1530002851	S.TR 2SC4116-BL (TE85R,F)	B	88.8/47.7
Q14	1530002851	S.TR 2SC4116-BL (TE85R,F)	B	29.6/104.5
Q15	1530002851	S.TR 2SC4116-BL (TE85R,F)	B	92.7/44.6
Q16	1530002851	S.TR 2SC4116-BL (TE85R,F)	B	33.3/104.5
Q19	1530002601	S.TR 2SC4215-O (TE85R,F)	B	63.2/106.8
Q20	1530002920	S.TR 2SC4226-T1 R25	B	38.8/123.1
Q21	1530002920	S.TR 2SC4226-T1 R25	B	39.6/114.5
Q22	1530002920	S.TR 2SC4226-T1 R25	B	94.6/64.3
Q23	1530002920	S.TR 2SC4226-T1 R25	B	95.2/55.4
Q24	1530003311	S.TR 2SC5107-O (TE85R,F)	B	100.5/58.6
Q25	1530003311	S.TR 2SC5107-O (TE85R,F)	B	44.9/116.2
Q26	1590001400	S.TR XP1214 (TX)	B	40.5/117.8
Q27	1590001400	S.TR XP1214 (TX)	B	96/59.6
Q28	1590003290	S.TR UNR9213J-(TX)	B	93.3/59.6
Q29	1590003290	S.TR UNR9213J-(TX)	T	57.2/41.9
Q30	1590003290	S.TR UNR9213J-(TX)	B	37.8/117.8
Q31	1590003230	S.TR UNR9113J-(TX)	T	57.2/39.8
Q32	1530003980	S.TR 2SC5700WB-TR-E	B	46.5/109.1
Q33	1530003980	S.TR 2SC5700WB-TR-E	B	102.1/53.4
Q34	1530003311	S.TR 2SC5107-O (TE85R,F)	B	46.2/123.1
Q35	1530003311	S.TR 2SC5107-O (TE85R,F)	B	101.9/64.4
Q36	1580000731	S.FET 3SK293 (TE85L,F)	B	47.3/136.1
Q37	1530003311	S.TR 2SC5107-O (TE85R,F)	B	132.5/84.5
Q38	1530002680	S.TR 2SC3335-T1	B	138.1/88.8
Q39	1560000841	S.FET 2SK1829 (TE85R,F)	T	53.2/140.8
Q40	1590001190	S.TR XP6501-(TX).AB	T	101.6/87.4
Q41	1520000460	S.TR 2SB1132 T100 R	T	101.6/82.8
Q42	1590003290	S.TR UNR9213J-(TX)	T	13.3/67.6
Q43	1590003290	S.TR UNR9213J-(TX)	T	138.8/122.9
Q44	1590003290	S.TR UNR9213J-(TX)	T	122.8/79.2
Q45	1540000550	S.TR 2SD1664 T100Q	T	117/76.3
Q46	1530002851	S.TR 2SC4116-BL (TE85R,F)	T	137.4/120.3
Q48	1510000920	S.TR 2SA1577 T106 Q	T	101.5/77.8
Q49	1590003290	S.TR UNR9213J-(TX)	T	102.2/73.7
Q52	1590003290	S.TR UNR9213J-(TX)	T	10.9/131.6
Q53	1590003290	S.TR UNR9213J-(TX)	T	10.9/129.6
Q56	1590003321	S.FET TPC6103 (TE85L,F)	T	7.6/132.6
Q57	1550000100	S.FET 2SJ377 (TE16L,NQ)	T	125.2/99.6
Q58	1590003290	S.TR UNR9213J-(TX)	T	130.2/102.1
Q59	1590000990	S.TR DTC363EK T146	T	7.6/127.6
Q61	1530002851	S.TR 2SC4116-BL (TE85R,F)	T	6.8/118.4
Q62	1540000441	S.TR 2SD1619T-TD-E	T	118.4/18.5
Q63	1560000990	S.FET PMBFJ310	B	66.3/110
Q64	1560000990	S.FET PMBFJ310	B	63.3/110
Q65	1530003311	S.TR 2SC5107-O (TE85R,F)	B	59.6/123.7

## [MAIN UNIT]

REF NO.	ORDER NO.	DESCRIPTION	M.	H/V LOCATION
Q66	1590003290	S.TR UNR9213J-(TX)	B	94.9/4.7
Q67	1590003290	S.TR UNR9213J-(TX)	B	124.9/4.7
Q68	1590003290	S.TR UNR9213J-(TX)	B	109.9/4.7
Q69	1590003290	S.TR UNR9213J-(TX)	T	9.5/53.3
Q70	1590003230	S.TR UNR9113J-(TX)	T	9.5/51
D1	1750001070	S.DIO DAN235ETL	B	57.3/78.6
D2	1750001070	S.DIO DAN235ETL	B	50/79.7
D3	1790001621	S.DIO 1SV308 (TPL3,F)	B	70.3/93.4
D4	1790001621	S.DIO 1SV308 (TPL3,F)	B	67.8/93.4
D7	1750001150	S.VCP HVC383BTRF-E	B	30.8/122.3
D8	1750001150	S.VCP HVC383BTRF-E	B	30.6/112.7
D9	1750001150	S.VCP HVC383BTRF-E	B	85.6/63.5
D10	1750001150	S.VCP HVC383BTRF-E	B	85.7/53.3
D11	1790001621	S.DIO 1SV308 (TPL3,F)	B	63.5/103.1
D12	1790001621	S.DIO 1SV308 (TPL3,F)	B	62.7/101.1
D13	1750000711	S.VCP HVC350BTRF-E	B	87.3/66.8
D14	1750000711	S.VCP HVC350BTRF-E	B	87.1/55.4
D15	1750000711	S.VCP HVC350BTRF-E	B	32.6/125.4
D16	1750000711	S.VCP HVC350BTRF-E	B	32/114.5
D17	1720000570	S.VCP MA368 (TX)	B	94.6/66.6
D18	1720000570	S.VCP MA368 (TX)	B	91.4/57.7
D19	1750000520	S.DIO DAN222TL	T	59.6/39.8
D20	1790001260	S.DIO MA2S077-(TX)	T	38.9/57.8
D21	1750000711	S.VCP HVC350BTRF-E	B	66.1/135.8
D22	1750000711	S.VCP HVC350BTRF-E	B	62.9/135.8
D24	1750000711	S.VCP HVC350BTRF-E	B	56.1/135.9
D27	1790001250	S.DIO MA2S111-(TX)	B	57.2/140.4
D28	1750000711	S.VCP HVC350BTRF-E	B	35.9/134.4
D29	1750000711	S.VCP HVC350BTRF-E	B	37.1/134.4
D31	1750000711	S.VCP HVC350BTRF-E	B	32.4/136.5
D32	1750000711	S.VCP HVC350BTRF-E	B	32.4/135.3
D33	1790001240	S.DIO MA2S728-(TX)	B	57.8/144.2
D34	1790001260	S.DIO MA2S077-(TX)	B	85.4/137.8
D38	1750001360	S.DIO L709CER (9401)	B	87.8/135.6
D40	1750000370	S.DIO DA221 TL	T	112.6/77
D44	1710001061	DIO L407CDB		
D45	1790001211	S.DIO 1SS375-TL-E	B	96.3/138.1
D46	1750000520	S.DIO DAN222TL	T	13.3/131.1
D47	1750000520	S.DIO DAN222TL	T	13.2/129.1
D48	1790000660	S.DIO MA728 (TX)	B	121.1/142.5
D49	1790000660	S.DIO MA728 (TX)	B	140.6/133
D51	1790001250	S.DIO MA2S111-(TX)	T	10.5/127.1
D53	1790001810	S.VSR AVR-M1005C080MTABB	T	32.5/11.5
D55	1790001810	S.VSR AVR-M1005C080MTABB	T	30.5/11.5
D56	1790001810	S.VSR AVR-M1005C080MTABB	B	33.2/22.1
D59	1790000700	DIO DSA3A1		
D61	1160000070	S.DIO DAN202K T146	T	118.4/14.3
D62	1750000431	S.DIO HSB88WSTR-E	B	68.3/123.3
D63	1790001250	S.DIO MA2S111-(TX)	B	34.1/20.7
D64	1750000370	S.DIO DA221 TL	T	63.2/93.9
D65	1750000370	S.DIO DA221 TL	T	65.2/93.9
D66	1750000370	S.DIO DA221 TL	T	67.2/93.9
D67	1750000370	S.DIO DA221 TL	T	62.5/105.6
D68	1750000370	S.DIO DA221 TL	T	60.5/104.7
D69	1750000370	S.DIO DA221 TL	T	69.2/93.9
D70	1750000370	S.DIO DA221 TL	T	71.2/93.9
D71	1750000370	S.DIO DA221 TL	T	69.4/109.5
D72	1750000370	S.DIO DA221 TL	T	71.5/109.5
D73	1750000370	S.DIO DA221 TL	T	73.5/109.5
D74	1750000370	S.DIO DA221 TL	T	75.6/109.5
D75	1790001250	S.DIO MA2S111-(TX)	B	41/38.6
D76	1790001250	S.DIO MA2S111-(TX)	B	26.4/41.3
D77	1790001250	S.DIO MA2S111-(TX)	B	49.4/29.9
D78	1730002360	S.ZEN MA8062-M (TX)	B	52.3/29.9
F11	2020001520	CER CFWLA450KFFA-B0		
F12	2020001460	CER CFWLA450KFFA-B0		
F13	2030000500	S.MLH FL-401 (46.35 MHz)	B	72/101
F14	2030000670	S.MLH FL-420 (46.35 MHz)	B	63.4/91.1
F15	2040001440	S.LC NFE31PT152Z1E9L	T	114.2/110.3
F16	2040001440	S.LC NFE31PT152Z1E9L	T	114.2/113.4
F17	2040001440	S.LC NFE31PT152Z1E9L	T	114.2/116.5
X1	6050012380	S.XTL CR-826 (15.3 MHz)	B	128.6/45.3
X2	6050012380	S.XTL CR-826 (15.3 MHz)	B	35.6/72.3
X3	6070000300	S.DCR JTBM450CX24 <JJE>	B	63.5/83.5
X4	6050012350	S.XTL CR-817 (12.288 MHz)	B	52.8/38.2
X5	6050012680	S.XTL CR-858 (SMD-49H.432MHZ)	T	46.9/52.7
L1	6200004660	S.COL MLF1608A 1R8K-T	B	115.6/39.2
L2	6200004660	S.COL MLF1608A 1R8K-T	B	23.6/82.4
L3	6200004480	S.COL MLF1608D R82K-T	B	39.4/79.3
L4	6200003540	S.COL MLF1608D R22K-T	B	36.9/76.9
L5	6200005661	S.COL ELJRE 10NGFA [High band]	B	102.7/46.7
	6200005671	S.COL ELJRE 12NGFA [Low band]	B	102.7/46.7
L6	6200005671	S.COL ELJRE 12NGFA	B	44.6/99.3
L8	6200004741	S.COL NLV25T-1R2J	B	28.5/121.7
L9	6200004741	S.COL NLV25T-1R2J	B	28.5/124.9
L10	6200004741	S.COL NLV25T-1R2J	B	28.5/114.1
L11	6200004741	S.COL NLV25T-1R2J	B	83.7/63.1
L12	6200004741	S.COL NLV25T-1R2J	B	83.7/54.6
L13	6200004741	S.COL NLV25T-1R2J	B	30.6/117.2
L14	6200004741	S.COL NLV25T-1R2J	B	84.2/66.2

M.=Mounted side (T: Mounted on the Top side, B: Mounted on the Bottom side)  
S.=Surface mount

[MAIN UNIT]

REF NO.	ORDER NO.	DESCRIPTION	M.	H/V LOCATION
L15	6200004741	S.COL NLV25T-1R2J	B	84.2/57.7
L18	6200009260	S.COL C3328A-5N0J-A	B	88.7/63.1
L19	6200009260	S.COL C3328A-5N0J-A	B	89.8/54
L20	6200009390	S.COL C3328A-8N0J-A	B	33.2/121.7
L21	6200009390	S.COL C3328A-8N0J-A	B	34.7/113.1
L22	6200003550	S.COL MLF1608A 4R7K-T	B	73.4/109.9
L23	6200002861	S.COL NLV25T-4R7J	B	57.6/108.9
L24	6200010740	S.COL C2520C-R27G-A	B	70/109.1
L25	6200004741	S.COL NLV25T-1R2J	B	97.1/64.6
L26	6200004741	S.COL NLV25T-1R2J	B	98.1/53.9
L27	6130002961	S.COL #617DB-1327=P3	B	68.3/117
L28	6200005711	S.COL ELJRE 27NGFA	B	62.3/123.6
L29	6200005721	S.COL ELJRE 33NGFA	B	102.6/58.6
L30	6200005721	S.COL ELJRE 33NGFA	B	46.9/116.2
L31	6200002861	S.COL NLV25T-4R7J	T	91.1/19.9
L32	6130002961	S.COL #617DB-1327=P3	B	68.3/128.7
L33	6200005671	S.COL ELJRE 12NGFA	B	47.3/107.1
L34	6200005691	S.COL ELJRE 18NGFA [High band]	B	61.1/117.5
	6200005711	S.COL ELJRE 27NGFA [Low band]	B	61.1/117.5
L35	6200005661	S.COL ELJRE 10NGFA [High band]	B	102.7/51.6
	6200005671	S.COL ELJRE 12NGFA [Low band]	B	102.7/51.6
L36	6200005711	S.COL ELJRE 27NGFA	B	44.3/123.1
L37	6200005691	S.COL ELJRE 18NGFA [High band]	B	61.1/120.1
	6200005711	S.COL ELJRE 27NGFA [Low band]	B	61.1/120.1
L38	6200005711	S.COL ELJRE 27NGFA	B	100/64.4
L39	6200009320	S.COL C3328A-12NG-A	B	70.8/137.3
L40	6200009320	S.COL C3328A-12NG-A	B	59.5/135.7
L41	6200009320	S.COL C3328A-12NG-A	B	51.4/136.3
L42	6200005711	S.COL ELJRE 27NGFA	B	134.7/83.8
L43	6200005711	S.COL ELJRE 27NGFA	B	142/87.1
L44	6200010290	S.COL C6328A-22NG-A [Low band]	B	41.9/136.2
	6200013490	S.COL C6328A-17NG-A [High band]	B	41.9/136.2
L45	6200005641	S.COL ELJRE 6N8ZF	B	142.7/90.6
L46	6200005671	S.COL ELJRE 12NGFA [EUR-01]	B	142/94.6
	6200005691	S.COL ELJRE 18NGFA except [EUR-01]	B	142/94.6
L47	6200010290	S.COL C6328A-22NG-A [Low band]	B	34.8/140.3
	6200013490	S.COL C6328A-17NG-A [High band]	B	34.8/140.3
L48	6200010100	S.COL C2012C-33NG-A	B	39.7/142.2
L49	6200010040	S.COL AS100340-10N	B	95.5/119.7
L50	6200005691	S.COL ELJRE 18NGFA	B	88/137.7
L52	6200010420	S.COL FHW1210HC 1R0JGT <JJE>	B	86.6/122.3
L53	6200010150	S.COL AS080340-15N	B	92.5/134.3
L54	6200010150	S.COL AS080340-15N	B	99.7/133.8
L55	6200010150	S.COL AS080340-15N	B	107.5/135.8
L56	6200010150	S.COL AS080340-15N	B	114.4/138.9
L57	6200010150	S.COL AS080340-15N	B	144.6/142.1
L58	6200002861	S.COL NLV25T-4R7J	T	55.4/37.5
L59	6200010420	S.COL FHW1210HC 1R0JGT <JJE>	B	147.1/146.2
L60	6200010420	S.COL FHW1210HC 1R0JGT <JJE>	B	24.5/145
L61	6200002961	S.COL NLV32T-4R7J	T	118.4/23.8
L65	6200004741	S.COL NLV25T-1R2J	B	41.3/123.3
L66	6200004741	S.COL NLV25T-1R2J	B	42.8/113.5
R1	7030005700	S.RES ERJ2GEJ 274 X (270 k)	T	54.5/63.5
R2	7030005050	S.RES ERJ2GEJ 103 X (10 k)	T	59/61.8
R3	7030005240	S.RES ERJ2GEJ 473 X (47 k)	T	62.4/69.6
R4	7030007340	S.RES ERJ2GEJ 153 X (15 k)	B	57.3/80.1
R6	7030007300	S.RES ERJ2GEJ 332 X (3.3 k)	T	9.5/57.1
R7	7030010040	S.RES ERJ2GEJ-JPW	T	61.6/66.3
R8	7030005160	S.RES ERJ2GEJ 105 X (1 M)	T	24.9/70.4
R9	7030005160	S.RES ERJ2GEJ 105 X (1 M)	T	25.8/70.4
R10	7030005160	S.RES ERJ2GEJ 105 X (1 M)	T	26.7/70.4
R12	7510001730	S.TMR ERTJ0EP 473J	B	129.1/49.3
R13	7030005090	S.RES ERJ2GEJ 104 X (100 k)	B	130.8/49.3
R15	7030007340	S.RES ERJ2GEJ 153 X (15 k)	B	54.5/78.3
R17	7030004980	S.RES ERJ2GEJ 101 X (100)	T	19.8/68.8
R18	7030007340	S.RES ERJ2GEJ 153 X (15 k)	B	55.3/79.2
R20	7030008300	S.RES ERJ2GEJ 184 X (180 k)	T	56.2/63.5
R22	7410001130	S.ARY EXB28V102JX	B	122.6/39
R23	7410001130	S.ARY EXB28V102JX	B	23.1/76.3
R25	7030004970	S.RES ERJ2GEJ 470 X (47)	B	65.3/79.4
R26	7030010040	S.RES ERJ2GEJ-JPW	B	57.8/64.5
R27	7030005120	S.RES ERJ2GEJ 102 X (1 k)	T	57.8/51
R29	7030007570	S.RES ERJ2GEJ 122 X (1.2 k)	B	35.8/75.5
R30	7030007340	S.RES ERJ2GEJ 153 X (15 k)	B	52.8/81.1
R32	7030007340	S.RES ERJ2GEJ 153 X (15 k)	B	51.2/78.3
R33	7030007340	S.RES ERJ2GEJ 153 X (15 k)	B	48.4/78.2
R34	7030005240	S.RES ERJ2GEJ 473 X (47 k)	T	27.1/68.1
R35	7030005240	S.RES ERJ2GEJ 473 X (47 k)	T	28/68.1
R36	7030005240	S.RES ERJ2GEJ 473 X (47 k)	T	28.9/68.1
R38	7030005230	S.RES ERJ2GEJ 334 X (330 k)	T	27.6/70.4
R39	7030005230	S.RES ERJ2GEJ 334 X (330 k)	T	28.6/70.4
R40	7030005230	S.RES ERJ2GEJ 334 X (330 k)	T	29.5/70.4
R41	7030005240	S.RES ERJ2GEJ 473 X (47 k)	B	68.2/78.2
R42	7030007060	S.RES ERJ2GEJ 684X (680 k)	B	34.6/75.9
R43	7030007290	S.RES ERJ2GEJ 222 X (2.2 k)	B	62.8/77.7
R44	7030005030	S.RES ERJ2GEJ 152 X (1.5 k)	B	71.4/78.2
R45	7030004970	S.RES ERJ2GEJ 470 X (47)	B	64.6/75.5
R46	7030005000	S.RES ERJ2GEJ 471 X (470)	T	52.7/57.1
R47	7030005290	S.RES ERJ2GEJ 682 X (6.8 k)	B	64.6/76.4
R48	7030005030	S.RES ERJ2GEJ 152 X (1.5 k)	B	62.8/76.4
R49	7030010040	S.RES ERJ2GEJ-JPW	T	55.2/57
R52	7030004980	S.RES ERJ2GEJ 101 X (100)	B	34.1/56.4
R53	7030005210	S.RES ERJ2GEJ 822 X (8.2 k)	B	16.8/57.6
R54	7030005000	S.RES ERJ2GEJ 471 X (470)	B	19.4/64.3
R56	7030004970	S.RES ERJ2GEJ 470 X (47)	B	121.9/50.4
R57	7030005040	S.RES ERJ2GEJ 472 X (4.7 k)	B	62.8/75.5
R58	7030008290	S.RES ERJ2GEJ 183 X (18 k)	B	56.5/49
R59	7030008290	S.RES ERJ2GEJ 183 X (18 k)	B	57.4/49
R60	7030005000	S.RES ERJ2GEJ 471 X (470)	B	33.1/75.2
R62	7030005120	S.RES ERJ2GEJ 102 X (1 k)	B	18.5/62.5
R63	7030005090	S.RES ERJ2GEJ 104 X (100 k)	T	55.5/60
R65	7030005000	S.RES ERJ2GEJ 471 X (470)	B	125.1/47.3

[MAIN UNIT]

REF NO.	ORDER NO.	DESCRIPTION	M.	H/V LOCATION
R66	7030004980	S.RES ERJ2GEJ 101 X (100)	B	56.5/50.6
R68	7030005040	S.RES ERJ2GEJ 472 X (4.7 k)	B	67.5/86.7
R69	7030005120	S.RES ERJ2GEJ 102 X (1 k)	B	32.7/83.3
R71	7030005240	S.RES ERJ2GEJ 473 X (47 k)	B	31/62.6
R72	7030004980	S.RES ERJ2GEJ 101 X (100)	B	57.6/44.2
R75	7030005110	S.RES ERJ2GEJ 224 X (220 k)	B	39.9/71.1
R76	7030005120	S.RES ERJ2GEJ 102 X (1 k)	B	91/41.5
R77	7030005580	S.RES ERJ2GEJ 560 X (56)	B	119.7/48.8
R78	7030005120	S.RES ERJ2GEJ 102 X (1 k)	B	29.6/99.3
R79	7030005580	S.RES ERJ2GEJ 560 X (56)	B	32.7/79.5
R80	7030004970	S.RES ERJ2GEJ 470 X (47)	B	23.5/41.1
R81	7030007250	S.RES ERJ2GEJ 220 X (22)	B	49.9/50.5
R82	7030008400	S.RES ERJ2GEJ 182 X (1.8 k)	B	56/44.2
R84	7030007290	S.RES ERJ2GEJ 222 X (2.2 k)	B	95.4/45.4
R85	7030007290	S.RES ERJ2GEJ 222 X (2.2 k)	B	36.9/105.6
R87	7030005090	S.RES ERJ2GEJ 104 X (100 k)	B	73.7/81.1
R88	7030005530	S.RES ERJ2GEJ 100 X (10)	B	39/71.1
R89	7030008400	S.RES ERJ2GEJ 182 X (1.8 k)	B	67.1/83.2
R90	7030008010	S.RES ERJ2GEJ 123 X (12 k)	T	54.5/73.3
R91	7030007570	S.RES ERJ2GEJ 122 X (1.2 k)	B	94.5/45.4
R92	7030005290	S.RES ERJ2GEJ 682 X (6.8 k)	B	86.7/41.5
R93	7030007570	S.RES ERJ2GEJ 122 X (1.2 k)	B	35.1/105.6
R94	7030005290	S.RES ERJ2GEJ 682 X (6.8 k)	B	28/98.3
R97	7410001170	S.ARY EXB28V470JX	B	42.9/49.9
R98	7030005530	S.RES ERJ2GEJ 100 X (10)	B	70.7/90.4
R99	7030005110	S.RES ERJ2GEJ 224 X (220 k)	B	70.7/91.3
R100	7030007570	S.RES ERJ2GEJ 122 X (1.2 k)	B	69.1/92.0
R101	7030004980	S.RES ERJ2GEJ 101 X (100)	B	86.7/43.7
R102	7030004980	S.RES ERJ2GEJ 101 X (100)	B	31.5/105.6
R103	7030004980	S.RES ERJ2GEJ 101 X (100)	B	27.8/103.9
R104	7030005050	S.RES ERJ2GEJ 103 X (10 k)	B	86.7/45.4
R105	7030005050	S.RES ERJ2GEJ 103 X (10 k)	B	31.5/109
R106	7030005050	S.RES ERJ2GEJ 103 X (10 k)	B	27.8/105.6
R107	7030004980	S.RES ERJ2GEJ 101 X (100)	B	90.8/45.4
R108	7030005030	S.RES ERJ2GEJ 152 X (1.5 k)	B	90.8/43.7
R109	7030005090	S.RES ERJ2GEJ 104 X (100 k)	B	65.7/100.1
R110	7030005810	S.RES RR0510P-152-D (1.5 k)	B	31.5/103.9
R111	7030005090	S.RES ERJ2GEJ 104 X (100 k)	B	37.8/105.6
R112	7030005220	S.RES ERJ2GEJ 223 X (22 k)	B	86.7/47.1
R113	7030005220	S.RES ERJ2GEJ 223 X (22 k)	B	27.8/107.3
R114	7030007300	S.RES ERJ2GEJ 332 X (3.3 k)	B	69.4/94.8
R115	7030007300	S.RES ERJ2GEJ 332 X (3.3 k)	B	66.8/96.2
R116	7030005050	S.RES ERJ2GEJ 103 X (10 k)	B	90.8/48.8
R117	7030005120	S.RES ERJ2GEJ 102 X (1 k)	B	90.8/47.1
R118	7030007280	S.RES ERJ2GEJ 331 X (330)	B	72.8/94.8
R119	7030007270	S.RES ERJ2GEJ 151 X (150)	B	67.2/90
R120	7030005800	S.RES RR0510P-102-D (1 k)	B	31.5/107.3
R121	7030009820	S.RES RR0510P-681-D (680)	B	26.2/109
R122	7030004970	S.RES ERJ2GEJ 470 X (47)	B	56.6/33.9
R123	7030004970	S.RES ERJ2GEJ 470 X (47)	B	49.5/38.5
R124	7030005240	S.RES ERJ2GEJ 473 X (47 k)	B	55.3/38.3
R125	7030007280	S.RES ERJ2GEJ 331 X (330)	B	82.6/51
R126	7030007290	S.RES ERJ2GEJ 224 X (2.2 k)	B	94.5/43.7
R127	7030005700	S.RES ERJ2GEJ 272 X (270 k)	T	61.2/51
R128	7030007290	S.RES ERJ2GEJ 222 X (2.2 k)	B	35.1/103.9
R129	7030005240	S.RES ERJ2GEJ 473 X (47 k)	B	55.3/35.1
R130	7030005240	S.RES ERJ2GEJ 473 X (47 k)	B	56.2/36.7
R131	7030004980	S.RES ERJ2GEJ 101 X (100)	B	54.2/32.4
R132	7030007290	S.RES ERJ2GEJ 222 X (2.2 k)	B	50.8/34.9
R133	7030007280	S.RES ERJ2GEJ 331 X (330)	B	67.5/104.4
R134	7030007270	S.RES ERJ2GEJ 151 X (150)	B	62.7/97.1
R136	7030005110	S.RES ERJ2GEJ 224 X (220 k)	B	81.7/65.3
R137	7030005110	S.RES ERJ2GEJ 224 X (220 k)	B	81.7/65.8
R140	7030007300	S.RES ERJ2GEJ 332 X (3.3 k)	B	63.8/101.1
R142	7030007300	S.RES ERJ2GEJ 332 X (3.3 k)	B	65.7/103.1
R143	7030005240	S.RES ERJ2GEJ 473 X (47 k)	B	48.6/38.5
R144	7030005240	S.RES ERJ2GEJ 473 X (47 k)	B	48.6/36.8
R145	7030010040	S.RES ERJ2GEJ-JPW	B	47.3/37.3
R146	7030005090	S.RES ERJ2GEJ 104 X (100 k)	B	97.3/47.1
R147	7030005290	S.RES ERJ2GEJ 682 X (6.8 k)	B	98.2/47.1
R148	7030004980	S.RES ERJ2GEJ 101 X (100)	B	59.3/106.8
R149	7030008290	S.RES ERJ2GEJ 183 X (18 k)	B	97.3/48.8
R150	7030005110	S.RES ERJ2GEJ 224 X (220 k)	B	91.5/66.6
R151	7030005110	S.RES ERJ2GEJ 224 X (220 k)	B	88.9/58.2
R152	7030005070	S.RES ERJ2GEJ 683 X (68 k)	B	65.2/107.0
R153	7030005000	S.RES ERJ2GEJ 471 X (470)	B	61.4/104.4
R154	7030006020	S.RES RR0510P-682-D (6.8 k)	B	36.8/121.9
R155	7030006020	S.RES RR0510P-682-D (6.8 k)	B	36.5/120.7
R156	7030006020	S.RES RR0510P-682-D (6.8 k)	B	37.4/112.2
R157	7030005530	S.RES ERJ2GEJ 100 X (10)	B	92.4/66.6
R158	7030005530	S.RES ERJ2GEJ 100 X (10)	B	88.9/57.2
R159	7030005530	S.RES ERJ2GEJ 100 X (10)	B	65.2/106.1
R160	7030010040	S.RES ERJ2GEJ-JPW	B	36.8/123.7
R161	7030			



[MAIN UNIT]

REF NO.	ORDER NO.	DESCRIPTION	M.	H/V LOCATION
R185	7030010040	S.RES ERJ2GEJ-JPW	B	62.3/117.5
R186	7030005120	S.RES ERJ2GEJ 102 X (1 k)	T	39.2/50.7
R187	7030008010	S.RES ERJ2GEJ 123 X (12 k)	T	41.5/55.9
R188	7410001150	S.ARY EXB28V471JX	T	48.5/41.1
R189	7030005090	S.RES ERJ2GEJ 104 X (100 k)	T	55.6/39.5
R190	7030008010	S.RES ERJ2GEJ 123 X (12 k)	T	43.1/55.9
R191	7030005000	S.RES ERJ2GEJ 471 X (470 k)	B	44/109.1
R192	7030005110	S.RES ERJ2GEJ 224 X (220 k)	B	44.9/109.1
R194	7030004980	S.RES ERJ2GEJ 101 X (100)	B	100.5/51.7
R195	7030005110	S.RES ERJ2GEJ 224 X (220 k)	B	100.5/53.4
R196	7030007260	S.RES ERJ2GEJ 330 X (33)	B	48/120.7
R197	7030005050	S.RES ERJ2GEJ 103 X (10 k)	T	40.5/50.6
R198	7030007260	S.RES ERJ2GEJ 330 X (33)	B	103.7/62
R199	7030005050	S.RES ERJ2GEJ 103 X (10 k)	T	67.6/57.5
R200	7030004980	S.RES ERJ2GEJ 101 X (100)	B	43.1/122.6
R201	7030005070	S.RES ERJ2GEJ 683 X (68 k)	B	48/122.6
R202	7030005160	S.RES ERJ2GEJ 105 X (1 M)	T	41.4/48.6
R204	7030005050	S.RES ERJ2GEJ 103 X (10 k)	T	54.7/39.5
R205	7030008010	S.RES ERJ2GEJ 123 X (12 k)	T	34.5/57.9
R207	7030005070	S.RES ERJ2GEJ 683 X (68 k)	B	103.7/64
R208	7030010040	S.RES ERJ2GEJ-JPW	B	46.2/120.7
R209	7030005000	S.RES ERJ2GEJ 471 X (470)	T	67.6/56
R212	7410001140	S.ARY EXB28V104JX	T	52.3/41.1
R213	7030005530	S.RES ERJ2GEJ 100 X (10)	T	41.4/47.7
R214	7030004980	S.RES ERJ2GEJ 101 X (100)	B	98.9/64
R215	7030010040	S.RES ERJ2GEJ-JPW	B	100.9/62
R216	7410001140	S.ARY EXB28V104JX	T	17.3/52.4
R217	7410001140	S.ARY EXB28V104JX	T	38.6/56
R218	7030005110	S.RES ERJ2GEJ 224 X (220 k)	B	65/137.9
R220	7410001140	S.ARY EXB28V104JX	T	15.2/50.7
R222	7410001140	S.ARY EXB28V104JX	T	36.1/56
R223	7030005050	S.RES ERJ2GEJ 103 X (10 k)	B	64/136.3
R224	7410001150	S.ARY EXB28V471JX	T	30.4/53.1
R225	7030005110	S.RES ERJ2GEJ 224 X (220 k)	B	64/137.9
R226	7030005110	S.RES ERJ2GEJ 224 X (220 k)	B	57.2/136.1
R227	7410001150	S.ARY EXB28V471JX	T	42.9/28.9
R230	7410001150	S.ARY EXB28V471JX	T	28.6/50.9
R231	7030005010	S.RES ERJ2GEJ 681 X (680)	B	55/138
		except [EUR-01] [EUR-01]	B	55/138
R232	7410001150	S.ARY EXB28V471JX	T	25.9/49.4
R233	7030005530	S.RES ERJ2GEJ 100 X (10)	B	54.1/136.1
R234	7410001150	S.ARY EXB28V471JX	T	42.5/25.7
R235	7410001150	S.ARY EXB28V471JX	T	24.2/47.6
R236	7030005090	S.RES ERJ2GEJ 104 X (100 k)	B	133.1/82.8
R237	7030004970	S.RES ERJ2GEJ 470 X (47)	B	48.4/138.3
R238	7410001150	S.ARY EXB28V471JX	T	45.7/28.9
R239	7410001150	S.ARY EXB28V471JX	T	22.4/45.8
R240	7030004980	S.RES ERJ2GEJ 101 X (100)	B	135.8/84.5
R241	7030005710	S.RES ERJ2GEJ 121 X (12)	B	48.4/133.8
R242	7030009320	S.RES ERJ2GEJ 4R7 X (4.7)	B	47.4/138.3
R243	7030005090	S.RES ERJ2GEJ 104 X (100 k)	B	46.4/138.3
R244	7410001150	S.ARY EXB28V471JX	T	39.7/25.8
R245	7410001150	S.ARY EXB28V471JX	T	20.2/42.4
R246	7030005240	S.RES ERJ2GEJ 473 X (47 k)	B	44.4/136.1
R247	7030008290	S.RES ERJ2GEJ 183 X (18 k)	B	47.4/140.4
R248	7030005600	S.RES ERJ2GEJ 273 X (27 k)	B	137.4/85.8
R253	7030004970	S.RES ERJ2GEJ 470 X (47)	B	138.8/85.4
R255	7030008400	S.RES ERJ2GEJ 182 X (1.8 k)	B	51.4/140.4
R257	7410001140	S.ARY EXB28V104JX	T	14.5/45.7
R258	7030005110	S.RES ERJ2GEJ 224 X (220 k)	B	58.3/140.4
R259	7030005170	S.RES ERJ2GEJ 474 X (470 k)	B	56.1/140.4
R260	7030005050	S.RES ERJ2GEJ 103 X (10 k)	T	144.6/121.4
R261	7030005050	S.RES ERJ2GEJ 103 X (10 k)	T	52.5/25.2
R262	7030005090	S.RES ERJ2GEJ 104 X (100 k)	T	51.9/22.8
R263	7410001140	S.ARY EXB28V104JX	T	46.2/20
R264	7410001140	S.ARY EXB28V104JX	T	50.2/24
R265	7030007280	S.RES ERJ2GEJ 331 X (330)	T	143/121.4
R266	7030005090	S.RES ERJ2GEJ 104 X (100 k)	B	34.6/133.5
R267	7410001140	S.ARY EXB28V104JX	T	14.8/43.1
R268	7410001150	S.ARY EXB28V471JX	T	45.7/31.8
R269	7030007270	S.RES ERJ2GEJ 151 X (150)	B	142.6/92.6
R270	7030005050	S.RES ERJ2GEJ 103 X (10 k)	B	30.6/134
R271	7030005090	S.RES ERJ2GEJ 104 X (100 k)	T	23.8/26.7
R272	7410001150	S.ARY EXB28V471JX	T	17.9/32.3
R273	7410001150	S.ARY EXB28V471JX	T	17.9/35.1
R274	7030005090	S.RES ERJ2GEJ 104 X (100 k)	B	31.5/134
R277	7030004980	S.RES ERJ2GEJ 101 X (100)	T	143.4/126.6
R278	7030005090	S.RES ERJ2GEJ 104 X (100 k)	T	13.9/65.6
R279	7030007290	S.RES ERJ2GEJ 222 X (2.2 k)	T	103.6/88.4
R280	7030004990	S.RES ERJ2GEJ 221 X (220)	T	138.4/128.2
R281	7410001150	S.ARY EXB28V471JX	T	21.3/31.8
R282	7030005090	S.RES ERJ2GEJ 104 X (100 k)	T	37.8/20.3
R283	7030005100	S.RES ERJ2GEJ 154 X (150 k)	T	141.5/126.6
R285	7030005050	S.RES ERJ2GEJ 103 X (10 k)	T	101.6/79.5
R287	7410001140	S.ARY EXB28V104JX	T	49.7/27.7
R288	7030005110	S.RES ERJ2GEJ 224 X (220 k)	T	136.8/124.7
R289	7030006070	S.RES ERJ12VJ101U (100)	B	86.9/117.5
R290	7030005110	S.RES ERJ2GEJ 224 X (220 k)	T	137.2/122.6
R291	7030005040	S.RES ERJ2GEJ 472 X (4.7 k)	T	139.2/121.2
R292	7030005050	S.RES ERJ2GEJ 103 X (10 k)	T	139.3/128.2
R295	7030006610	S.RES ERJ2GEJ 394 X (390 k)	T	136.3/122.6
R296	7030007300	S.RES ERJ2GEJ 332 X (3.3 k)	T	121.8/77.2
R297	7030007300	S.RES ERJ2GEJ 332 X (3.3 k)	T	122.8/77.2
R298	7030000440	S.RES MCR10EZJH 3.3 k	T	120.4/77.3
R299	7030004980	S.RES ERJ2GEJ 101 X (100)	B	29.1/17.4
R300	7030005530	S.RES ERJ2GEJ 100 X (10)	T	47.6/73.1
R301	7030008300	S.RES ERJ2GEJ 184 X (180 k)	B	85.7/131
R303	7410001150	S.ARY EXB28V471JX	T	47.7/68.4
R304	7030005050	S.RES ERJ2GEJ 103 X (10 k)	B	95.4/135.9
R306	7520000260	S.POS PRF18BB471QB1RB	B	87.3/130.2
R308	7030007340	S.RES ERJ2GEJ 153 X (15 k) [EUR-01]	T	140.7/128.3
		except [EUR-01]	T	140.7/128.3

[MAIN UNIT]

REF NO.	ORDER NO.	DESCRIPTION	M.	H/V LOCATION
R309	7030005040	S.RES ERJ2GEJ 472 X (4.7 k)	T	102.2/75.7
R313	7030005050	S.RES ERJ2GEJ 103 X (10 k)	T	103.5/77.8
R315	7030005700	S.RES ERJ2GEJ 274 X (270 k)	B	98.6/137.3
R316	7030005050	S.RES ERJ2GEJ 103 X (10 k)	T	11.2/128.2
R320	7030005090	S.RES ERJ2GEJ 104 X (100 k)	T	15/124.1
R321	7030003320	S.RES ERJ3GEYJ 101 V (100)	B	119.5/142.1
R322	7030007350	S.RES ERJ2GEJ 393 X (39 k)	B	119.4/144.2
R324	7030005050	S.RES ERJ2GEJ 103 X (10 k)	B	31.3/12
R325	7030005120	S.RES ERJ2GEJ 102 X (1 k)	B	32.3/12
R326	7030005240	S.RES ERJ2GEJ 473 X (47 k)	T	13.2/125.7
R327	7030000220	S.RES MCR10EZJH 47 (470)	B	119.7/132.8
R328	7030000260	S.RES MCR10EZJH 100 (101)	B	139.3/144.3
R331	7030004980	S.RES ERJ2GEJ 101 X (100)	T	12/120
R332	7030003320	S.RES ERJ3GEYJ 101 V (100)	B	139.5/135
R333	7030007350	S.RES ERJ2GEJ 393 X (39 k)	B	139.3/131.4
R334	7030005651	S.RES ERA3YKD 304V (300 k)	T	57.8/30.5
R335	7030005871	S.RES ERA3YKD 104V (100 k)	T	55.9/29.7
R336	7030005110	S.RES ERJ2GEJ 224 X (220 k)	T	12/120.9
R337	7030005110	S.RES ERJ2GEJ 224 X (220 k)	T	13.2/120.6
R339	7030005090	S.RES ERJ2GEJ 104 X (100 k)	T	12/125.3
R341	7030005050	S.RES ERJ2GEJ 103 X (10 k)	B	33.3/12
R342	7030005090	S.RES ERJ2GEJ 104 X (100 k)	B	45.3/56.9
R346	7410001150	S.ARY EXB28V471JX	T	43.5/73.8
R347	7030005000	S.RES ERJ2GEJ 471 X (470)	T	9.8/132.9
R348	7030000620	S.RES MCR10EZJH 100 k	B	147.2/150.9
R349	7030000620	S.RES MCR10EZJH 100 k	B	26/149.7
R350	7030003350	S.RES ERJ3GEYJ 103 V (10 k)	B	6.4/131
R352	7030005040	S.RES ERJ2GEJ 472 X (4.7 k)	T	10.2/125.3
R353	7030005240	S.RES ERJ2GEJ 473 X (47 k)	B	55.8/56.9
R354	7030005700	S.RES ERJ2GEJ 274 X (270 k)	T	125.2/103.6
R355	7030005090	S.RES ERJ2GEJ 104 X (100 k)	T	129.2/103.6
R356	7030005050	S.RES ERJ2GEJ 103 X (10 k)	T	9.8/134.5
R357	7030003350	S.RES ERJ3GEYJ 103 V (10 k)	B	10.1/150.2
R362	7540000290	ABS ERZV10D220		
R364	7030005110	S.RES ERJ2GEJ 224 X (220 k)	T	65.1/71.2
R365	7030005050	S.RES ERJ2GEJ 103 X (10 k)	T	7.4/120.7
R366	703000722 X	S.RES ERJ2GEJ 222 X (2.2 k)	B	7/123.5
R367	7030004980	S.RES ERJ2GEJ 101 X (100)	T	9.7/117.3
R368	7030008300	S.RES ERJ2GEJ 184 X (180 k)	T	8.5/117.8
R369	7030005230	S.RES ERJ2GEJ 334 X (330 k)	T	9.7/118.2
R370	7030008280	S.RES ERJ2GEJ 271 X (270)	T	6.1/120.7
R371	7030010040	S.RES ERJ2GEJ-JPW	T	5/117.3
R372	7030005000	S.RES ERJ2GEJ 471 X (470)	T	115.3/15.8
R373	7030005050	S.RES ERJ2GEJ 103 X (10 k)	T	115.3/14
R374	7030000140	S.RES MCR10EZJH 10 (100)	T	111.2/12.3
R375	7030010040	S.RES ERJ2GEJ-JPW	T	100.1/16.3
R376	7030004980	S.RES ERJ2GEJ 101 X (100)	B	62.3/122.2
R377	7030005000	S.RES ERJ2GEJ 471 X (470)	B	62.3/124.7
R378	7030005210	S.RES ERJ2GEJ 822 X (8.2 k)	B	63.2/126.1
R379	7030005210	S.RES ERJ2GEJ 822 X (8.2 k)	B	59.6/126.1
R380	7030007260	S.RES ERJ2GEJ 300 X (33)	B	57.8/123.7
R381	7030004990	S.RES ERJ2GEJ 221 X (220) [Low band]	B	61.4/126.1
		7030007270 S.RES ERJ2GEJ 151 X (150) [High band]	B	61.4/126.1
R424	7410001150	S.ARY EXB28V471JX	T	46.3/42.9
R425	7410001150	S.ARY EXB28V471JX	T	36.8/23
R426	7410001150	S.ARY EXB28V471JX	T	47.8/93.9
R427	7030005000	S.RES ERJ2GEJ 471 X (470)	T	25.5/26.7
R428	7410001140	S.ARY EXB28V104JX	T	48/22.7
R429	7410001140	S.ARY EXB28V104JX	T	49.7/30.2
R430	7410001140	S.ARY EXB28V104JX	T	52.3/43.6
R431	7410001150	S.ARY EXB28V471JX	T	17.9/40.3
R432	7410001140	S.ARY EXB28V104JX	T	15.2/48.2
R433	7410001150	S.ARY EXB28V471JX	T	39.6/23
R434	7410000750	S.ARY EXB-V4V 104JV (100 k)	B	36.8/48.2
R435	7410001140	S.ARY EXB28V104JX	B	39.1/47.8
R436	7410001140	S.ARY EXB28V104JX	B	44.3/41.2
R438	7410001140	S.ARY EXB28V104JX	B	34.4/47.7
R443	7030005000	S.RES ERJ2GEJ 471 X (470)	T	60.4/59.2
R444	7030005240	S.RES ERJ2GEJ 473 X (47 k)	B	13.5/33.6
R445	7030005240	S.RES ERJ2GEJ 473 X (47 k)	B	13.5/36.1
R446	7030005240	S.RES ERJ2GEJ 473 X (47 k)	B	13.5/37.4
R447	7030005090	S.RES ERJ2GEJ 104 X (100 k)	T	50.2/19.2
R448	7030005090	S.RES ERJ2GEJ 104 X (100 k)	T	49.3/19.2
R449	7030005170	S.RES ERJ2GEJ 474 X (470 k)	T	39.5/19.2
R450	7030005050	S.RES ERJ2GEJ 103 X (10 k)	T	50.2/16.5
R453	7030005120	S.RES ERJ2GEJ 102 X (1 k)	T	52/13.9
R454	7030005120	S.RES ERJ2GEJ 102 X (1 k)	B	94.9/7.2
R455	7030005010	S.RES ERJ2GEJ 681 X (680)	B	124.9/2.7
R456	7030005120	S.RES ERJ2GEJ 102 X (1 k)	B	109.9/2.7
R467	7030005240	S.RES ERJ2GEJ 473 X (47 k)	B	38/44.6
R468	7410001140	S.ARY EXB28V104JX	B	31.8/48.5
R469				



[MAIN UNIT]

REF NO.	ORDER NO.	DESCRIPTION	M.	H/V LOCATION
R492	7030005240	S.RES ERJ2GEJ 473 X (47 k)	B	29.8/58.8
R493	7030010040	S.RES ERJ2GEJ-JPW	T	11.3/19
R494	7030005000	S.RES ERJ2GEJ 471 X (470)	T	73.2/98.2
R495	7030005100	S.RES ERJ2GEJ 154 X (150 k)	T	55.2/55.3
R496	7030005070	S.RES ERJ2GEJ 683 X (68 k)	T	52.7/56.2
R497	7030005700	S.RES ERJ2GEJ 274 X (270 k)	T	52.7/55.3
R498	7030005600	S.RES ERJ2GEJ 273 X (27 k)	B	61.4/103.1
R499	7030004980	S.RES ERJ2GEJ 101 X (100)	T	24.4/57
R500	7030005600	S.RES ERJ2GEJ 273 X (27 k)	T	21.2/57.5
R501	7030005220	S.RES ERJ2GEJ 223 X (22 k)	T	22.8/53.8
R502	7030005090	S.RES ERJ2GEJ 104 X (100 k)	T	28/55
R503	7030007350	S.RES ERJ2GEJ 393 X (39 k)	T	55.5/58.4
R505	7030010040	S.RES ERJ2GEJ-JPW	T	113.4/18.3
R506	7030005110	S.RES ERJ2GEJ 224 X (220 k)	T	113.4/19.3
R507	7030005090	S.RES ERJ2GEJ 104 X (100 k)	T	115/19.3
R508	7030010040	S.RES ERJ2GEJ-JPW	T	144.6/119.6
R509	7030005050	S.RES ERJ2GEJ 103 X (10 k)	B	33.3/15.2
R510	7030007350	S.RES ERJ2GEJ 393 X (39 k)	B	29/14.1
R511	7030005050	S.RES ERJ2GEJ 103 X (10 k)	B	29.1/18.5
R512	7030005050	S.RES ERJ2GEJ 103 X (10 k)	B	30.8/18.5
R513	7030007280	S.RES ERJ2GEJ 331 X (330)	B	72.3/90.4
R530	7030005240	S.RES ERJ2GEJ 473 X (47 k)	T	62.5/66.3
R531	7030007290	S.RES ERJ2GEJ 222 X (2.2 k)	B	64.6/78.2
R532	7030005000	S.RES ERJ2GEJ 471 X (470)	B	45.1/37.1
R533	7030005090	S.RES ERJ2GEJ 104 X (100 k)	B	57.2/18.4
R534	7030005600	S.RES ERJ2GEJ 273 X (27 k)	B	45.3/58.6
R535	7030004980	S.RES ERJ2GEJ 101 X (100)	B	55.8/55.3
R536	7030005600	S.RES ERJ2GEJ 273 X (27 k)	B	55.8/58.6
R537	7030010040	S.RES ERJ2GEJ-JPW	B	41.6/41.2
R539	7030005100	S.RES ERJ2GEJ 154 X (150 k)	T	64.2/71.2
R540	7030005090	S.RES ERJ2GEJ 104 X (100 k)	T	90.6/17.9
R541	7030005220	S.RES ERJ2GEJ 223 X (22 k)	T	28.9/55.5
R542	7030005110	S.RES ERJ2GEJ 224 X (220 k)	B	39.9/72.7
R543	7030005080	S.RES ERJ2GEJ 823 X (82 k)	B	40.8/71.1
C1	4030017420	S.CER ECJ0EC1H470J	B	120.7/39
C2	4030017420	S.CER ECJ0EC1H470J	B	22.9/78.1
C3	4030016930	S.CER ECJ0EB1A104K	B	130.8/50.2
C4	4030017420	S.CER ECJ0EC1H470J	B	122.2/37.1
C5	4030017420	S.CER ECJ0EC1H470J	B	21.7/77.1
C6	4030016930	S.CER ECJ0EB1A104K	B	52.4/77.9
C7	4030017420	S.CER ECJ0EC1H470J	B	123.1/37.1
C8	4030017420	S.CER ECJ0EC1H470J	B	21.7/75.5
C9	4030017460	S.CER ECJ0EB1E102K	T	17.6/59
C10	4030016930	S.CER ECJ0EB1A104K	B	55.7/77.9
C11	4030016930	S.CER ECJ0EB1A104K	B	124/37.1
C12	4030016930	S.CER ECJ0EB1A104K	B	22.1/74.3
C13	4030016930	S.CER ECJ0EB1A104K	B	55.6/80.7
C14	4030017460	S.CER ECJ0EB1E102K	T	16.1/59.9
C15	4030016930	S.CER ECJ0EB1A104K	B	62.4/67.5
C16	4030017420	S.CER ECJ0EC1H470J	B	56.2/64.5
C17	4030016930	S.CER ECJ0EB1A104K	B	115.6/40.6
C18	4030017700	S.CER ECJ0EC1H151J	T	62.4/71.2
C19	4030016930	S.CER ECJ0EB1A104K	B	22.9/80.3
C20	4550006250	S.TAN TEESVA 1A 106M8R	B	115.4/37.5
C21	4550006250	S.TAN TEESVA 1A 106M8R	B	21.3/80.5
C22	4030016930	S.CER ECJ0EB1A104K	B	50/77.9
C23	4030016930	S.CER ECJ0EB1A104K	T	57.8/52.6
C24	4030016930	S.CER ECJ0EB1A104K	B	50.3/81.1
C25	4030016930	S.CER ECJ0EB1A104K	B	54.4/81.1
C26	4030017460	S.CER ECJ0EB1E102K	B	117.8/39.2
C27	4030017460	S.CER ECJ0EB1E102K	B	23.8/80.3
C28	4030016930	S.CER ECJ0EB1A104K	B	53.3/77.9
C30	4030017460	S.CER ECJ0EB1E102K	T	59.8/67
C31	4030016930	S.CER ECJ0EB1A104K	T	60.5/53
C32	4030017590	S.CER ECJ0EC1H070C	B	38.4/79.1
C33	4030016930	S.CER ECJ0EB1A104K	T	58.9/67
C34	4030017570	S.CER ECJ0EC1H040B	B	37.2/78.7
C35	4030016930	S.CER ECJ0EB1A104K	B	38.3/76
C36	4030017500	S.CER ECJ0EC1H560J	B	37.2/79.6
C37	4030016930	S.CER ECJ0EB1A104K	B	48.4/79.8
C38	4030016930	S.CER ECJ0EB1A104K	B	69.8/78.2
C39	4030017360	S.CER ECJ0EC1H030B	B	71.4/77.3
C40	4030017760	S.CER ECJ0EB1H222K	B	68.2/77.3
C41	4030018860	S.CER ECJ0EB0J105K	B	31/58.2
C42	4030017760	S.CER ECJ0EB1H222K	B	68.2/76.4
C43	4030016930	S.CER ECJ0EB1A104K	B	55.6/49
C44	4030018860	S.CER ECJ0EB0J105K	B	35.7/56.4
C45	4030016950	S.CER ECJ0EB1A473K	B	34.5/55.2
C47	4030017460	S.CER ECJ0EB1E102K	B	64.6/77.3
C48	4030016930	S.CER ECJ0EB1A104K	T	52.7/54.4
C49	4030018860	S.CER ECJ0EB0J105K	B	15.6/58.3
C50	4030016930	S.CER ECJ0EB1A104K	B	130.8/48.4
C51	4030017620	S.CER ECJ0EC1H100C	B	125.1/45.3
C52	4030017420	S.CER ECJ0EC1H470J	B	120.6/48.8
C53	4030017420	S.CER ECJ0EC1H470J	B	32.7/78.4
C54	4030017660	S.CER ECJ0EC1H330J	B	32.7/77.3
C56	4030016950	S.CER ECJ0EB1A473K	B	31.9/59.1
C59	4030017430	S.CER ECJ0EC1H101J	B	32.7/76.4
C60	4030017620	S.CER ECJ0EC1H100C	B	32.3/72.9
C61	4030018900	S.CER ECJ0EB0J474K	B	18/63.8
C62	4030016930	S.CER ECJ0EB1A104K	B	63.3/55.2
C63	4030016930	S.CER ECJ0EB1A104K	T	55.5/61.6
C66	4030017430	S.CER ECJ0EC1H101J	B	123.5/48.4
C67	4030017460	S.CER ECJ0EB1E102K	B	67.5/87.7
C69	4030016930	S.CER ECJ0EB1A104K	B	29.8/63
C70	4030017460	S.CER ECJ0EB1E102K	B	64.3/79.4
C71	4030016930	S.CER ECJ0EB1A104K	B	57.6/43.3
C72	4030018910	S.CER C1608 JB 0J 475K-T	B	29.3/61.9
C73	4030017460	S.CER ECJ0EB1E102K	B	96.3/45.4
C75	4030017460	S.CER ECJ0EB1E102K	B	36/105.6
C77	4030016930	S.CER ECJ0EB1A104K	T	53.9/57.7
C78	4030017460	S.CER ECJ0EB1E102K	B	119.7/50.4

[MAIN UNIT]

REF NO.	ORDER NO.	DESCRIPTION	M.	H/V LOCATION
C79	4030017460	S.CER ECJ0EB1E102K	B	34.3/79.5
C80	4030017350	S.CER ECJ0EC1H020B [Low band]	B	102.4/45.6
	4030017550	S.CER ECJ0EC1H1R5B [High band]	B	102.4/45.6
C81	4030017350	S.CER ECJ0EC1H020B [Low band]	B	42.2/99.6
	4030017550	S.CER ECJ0EC1H1R5B [High band]	B	42.2/99.6
C82	4550006250	S.TAN TEESVA 1A 106M8R	B	61.1/79.2
C83	4030017460	S.CER ECJ0EB1E102K	B	71.7/86.7
C84	4030017420	S.CER ECJ0EC1H470J	B	74.7/81.1
C85	4030017590	S.CER ECJ0EC1H070C	B	56/43.3
C86	4030016930	S.CER ECJ0EB1A104K	B	51.7/47.1
C87	4030018910	S.CER C1608 JB 0J 475K-T	B	54.3/48.4
C88	4030017770	S.CER ECJ0EB1E332K	B	86.7/40.6
C89	4030017770	S.CER ECJ0EB1E332K	B	28/99.3
C90	4030017680	S.CER ECJ0EC1H820J	B	69.1/86.7
C91	4030016930	S.CER ECJ0EB1A104K	T	60.7/66.3
C92	4030016790	S.CER ECJ0EB1C103K	B	72.7/88
C93	4030017460	S.CER ECJ0EB1E102K	B	70/87.9
C96	4030018910	S.CER C1608 JB 0J 475K-T	B	49.2/48.9
C97	4030016930	S.CER ECJ0EB1A104K	B	57.4/50.6
C98	4030017460	S.CER ECJ0EB1E102K	B	35.1/107.3
C99	4030017460	S.CER ECJ0EB1E102K	B	40.8/72.7
C101	4030017620	S.CER ECJ0EC1H100C	B	37.7/63.2
C102	4550000560	S.TAN TEESVA 1V 334M8R	B	84.7/42.7
C103	4550003260	S.TAN TEESVA 1V 684M8R	B	26.2/100.4
C104	4030016930	S.CER ECJ0EB1A104K	B	39.9/74.5
C105	4030017520	S.CER ECJ0EC1HOR3B	B	103.2/47.8
C106	4030017340	S.CER ECJ0EC1H010B	B	47/100.1
C107	4030017590	S.CER ECJ0EC1H070C	B	72.3/89.5
C108	4030017460	S.CER ECJ0EB1E102K	B	94.5/47.1
C109	4030017530	S.CER ECJ0EC1HOR5B	B	101.9/48.3
C110	4030017530	S.CER ECJ0EC1HOR5B	B	46.5/101.4
C111	4030016790	S.CER ECJ0EB1C103K	B	70.7/92.3
C112	4550000270	S.TAN TEESVA 1E 474M8R	B	84.7/47.9
C113	4550000270	S.TAN TEESVA 1E 474M8R	B	26.2/105.6
C114	4030017520	S.CER ECJ0EC1HOR3B	B	103.2/49.6
C115	4030017340	S.CER ECJ0EC1H010B [High band]	B	47/102.8
	4030017550	S.CER ECJ0EC1H1R5B [Low band]	B	47/102.8
C116	4030017460	S.CER ECJ0EB1E102K	B	70.7/89.5
C117	4030016790	S.CER ECJ0EB1C103K	B	69.1/90.4
C118	4030016790	S.CER ECJ0EB1C103K	B	69.1/91.3
C121	4030016790	S.CER ECJ0EB1C103K	B	71.1/94.8
C122	4030016790	S.CER ECJ0EB1C103K	B	67.2/91.6
C123	4030016930	S.CER ECJ0EB1A104K	B	67.5/100.1
C124	4030016930	S.CER ECJ0EB1A104K	B	48.5/50.5
C125	4030016790	S.CER ECJ0EB1C103K	B	95.4/43.7
C126	4030016790	S.CER ECJ0EB1C103K	B	57.2/35.1
C127	4030016790	S.CER ECJ0EB1C103K	B	36/103.9
C133	4030017590	S.CER ECJ0EC1H070C	B	59.4/92.8
C134	4550003260	S.TAN TEESVA 1V 684M8R	B	26.2/112.4
C135	4030016930	S.CER ECJ0EB1A104K	B	37.8/103.9
C136	4030016930	S.CER ECJ0EB1A104K	B	50.4/36.8
C137	4030017620	S.CER ECJ0EC1H100C	B	56.2/38.3
C138	4030017640	S.CER ECJ0EC1H150J	B	75.8/101.1
C139	4030017650	S.CER ECJ0EC1H270J	B	59.4/91.9
C140	4030016930	S.CER ECJ0EB1A104K	B	55.3/36.7
C141	4550000270	S.TAN TEESVA 1E 474M8R	B	82.6/47.9
C144	4550006250	S.TAN TEESVA 1A 106M8R	B	94.7/41.5
C145	4030017420	S.CER ECJ0EC1H470J	B	50.4/38.5
C146	4030017460	S.CER ECJ0EB1E102K	B	56.2/35.1
C147	4550006250	S.TAN TEESVA 1A 106M8R	B	33.3/100.4
C149	4030016790	S.CER ECJ0EB1C103K	B	69.4/95.7
C150	4030016790	S.CER ECJ0EB1C103K	B	65.7/97.3
C151	4030017610	S.CER ECJ0EC1H090C	B	61.7/97.1
C152	4030016930	S.CER ECJ0EB1A104K	B	55.3/32.4
C153	4030017380	S.CER ECJ0EC1H050B	B	49.8/34.9
C154	4030017420	S.CER ECJ0EC1H470J	B	26.5/120.6
C155	4030017460	S.CER ECJ0EB1E102K	B	26.5/123.2
C156	4030017420	S.CER ECJ0EC1H470J	B	28.5/111.5
C157	4030017460	S.CER ECJ0EB1E102K	B	28/117.2
C158	4030017420	S.CER ECJ0EC1H470J	B	81.7/62.1
C159	4030017420	S.CER ECJ0EC1H470J	B	81.7/53.6
C160	4030016790	S.CER ECJ0EB1C103K	B	65.7/104.4
C161	4030016790	S.CER ECJ0EB1C103K	B	62.7/98.9
C162	4030016930	S.CER ECJ0EB1A104K	B	81.7/67.1
C163	4030016930	S.CER ECJ0EB1A104K	B	81.7/58.6
C164	4030016930	S.CER ECJ0EB1A104K	B	49.5/36.8
C165	4030017460	S.CER ECJ0EB1E102K	B	81.7/66.2
C166	4030017460	S.CER ECJ0EB1E102K	B	81.7/57.7
C167	4030017460	S.CER ECJ0EB1E102K	B	97.3/45.4
C168	4030017380	S.CER ECJ0EC1H050B	B	32.6/124.3
C169	4030017570	S.CER ECJ0EC1H040B	[High band]	B 30.8/124.4
	4030017620	S.CER ECJ0EC1H100C	[Low band]	B 30.8/124.4
C170	4030017580	S.CER ECJ0EC1H060C	B	30.6/114.4
C171	4030017380	S.CER ECJ0EC1H050B [High band]	B	30.6/115.3
	4030017630	S.CER ECJ0EC1H120J [Low band]	B	30.6/115.3
C172	4030017380	S.CER ECJ0EC1H050B [High band]	B	87.8/65.7
	4030017580	S.CER ECJ0EC1H060C [Low band]	B	87.8/6

[MAIN UNIT]

REF NO.	ORDER NO.	DESCRIPTION	M.	H/V LOCATION
C183	4030017420	S.CER ECJ0EC1H470J	T	14.9/131.3
C184	4030017620	S.CER ECJ0EC1H100C	B	34.9/124.3
C185	4030017610	S.CER ECJ0EC1H090C [High band]	B	35.4/115.3
	4030017630	S.CER ECJ0EC1H120J [Low band]	B	35.4/115.3
C186	4030017420	S.CER ECJ0EC1H470J	B	98.2/48.8
C187	4030017530	S.CER ECJ0EC1H0R5B [High band]	B	89.4/66.8
	4030017540	S.CER ECJ0EC1H1R75B [Low band]	B	89.4/66.8
C188	4030017360	S.CER ECJ0EC1H030B	B	90.6/66.6
C189	4030017340	S.CER ECJ0EC1H010B	B	87/57.2
C190	4030017340	S.CER ECJ0EC1H010B [High band]	B	87/58.2
	4030017350	S.CER ECJ0EC1H020B [Low band]	B	87/58.2
	4030017380	S.CER ECJ0EC1H050B [Low band]	B	89.4/65.7
	4030017630	S.CER ECJ0EC1H120J [High band]	B	89.4/65.7
C192	4030017600	S.CER ECJ0EC1H080C [High band]	B	90.5/56.3
	4030017630	S.CER ECJ0EC1H120J [Low band]	B	90.5/56.3
C193	4030017460	S.CER ECJ0EB1E102K	B	61.4/107.1
C194	4030017580	S.CER ECJ0EC1H060C [Low band]	B	36.8/122.8
	4030017600	S.CER ECJ0EC1H080C [High band]	B	36.8/122.8
	4030017630	S.CER ECJ0EC1H120J	B	40.1/120.7
C195	4030017620	S.CER ECJ0EC1H0100C	B	37.6/114.4
C196	4030017640	S.CER ECJ0EC1H150J	B	41/112.2
C198	4030016790	S.CER ECJ0EB1C103K	B	60.5/107.1
C200	4030017570	S.CER ECJ0EC1H040B	B	92.4/64.3
C201	4030017620	S.CER ECJ0EC1H100C	B	96/62
C202	4030017610	S.CER ECJ0EC1H090C	B	93.1/55.4
C203	4030017390	S.CER ECJ0EC1H180J	B	96.3/52.9
C204	4550006250	S.TAN TEESVA 1A 106M8R	T	81.7/17
C205	4550006250	S.TAN TEESVA 1A 106M8R	T	85.1/17
C206	4550006250	S.TAN TEESVA 1A 106M8R	T	88.8/16.7
C208	4030017490	S.CER C1608 JB 1A 105K-T	T	80/16.6
C209	4030017490	S.CER C1608 JB 1A 105K-T	T	83.4/16.6
C210	4030017490	S.CER C1608 JB 1A 105K-T	T	86.9/16.3
C211	4030016930	S.CER ECJ0EB1A104K	B	38.3/120.7
C212	4030016790	S.CER ECJ0EB1C103K	B	39.2/112.2
C213	4030017660	S.CER ECJ0EC1H330J	B	68.5/106.1
C214	4030017460	S.CER ECJ0EB1E102K	B	66.8/107
C215	4030017530	S.CER ECJ0EC1H0R5B	B	41.9/120.7
C216	4030017520	S.CER ECJ0EC1H0R3B	B	42.6/115.7
C217	4030017460	S.CER ECJ0EB1E102K	B	39.2/120.7
C218	4030017460	S.CER ECJ0EB1E102K	B	40.1/112.2
C219	4030016790	S.CER ECJ0EB1C103K	B	94.2/62
C220	4030017530	S.CER ECJ0EC1H0R5B	B	98.2/61.3
C221	4030016790	S.CER ECJ0EB1C103K	B	94.5/52.9
C222	4030017530	S.CER ECJ0EC1H0R5B	B	98.2/57.1
C224	4030017460	S.CER ECJ0EB1E102K	B	95.1/62
C225	4030017460	S.CER ECJ0EB1E102K	B	95.4/52.9
C228	4030017490	S.CER C1608 JB 1A 105K-T	T	79.8/24.4
C229	4030017490	S.CER C1608 JB 1A 105K-T	T	83.3/24.4
C230	4030017490	S.CER C1608 JB 1A 105K-T	T	86.8/24.4
C231	4550005980	S.TAN TEESVA 1A 475M8R	T	81.6/25.6
C232	4550005980	S.TAN TEESVA 1A 475M8R	T	85.1/25.6
C233	4550005980	S.TAN TEESVA 1A 475M8R	T	88.5/25.6
C235	4030017030	S.CER ECJ0EB1A273K	T	41/55
C236	4030017730	S.CER ECJ0EB1E471K	B	100.5/55
C237	4030017460	S.CER ECJ0EB1E102K	B	100.5/60.4
C238	4030017730	S.CER ECJ0EB1E471K	B	44.9/112.6
C239	4030017460	S.CER ECJ0EB1E102K	B	44.9/118
C240	4510008540	S.ELE EEEFK1C100SR	T	95.1/22.3
C241	4030017350	S.CER ECJ0EC1H020B	B	68.3/120.9
C242	4030016790	S.CER ECJ0EB1C103K	B	68.7/111.2
C243	4030017460	S.CER ECJ0EB1E102K	B	70.3/106.1
C244	4030016790	S.CER ECJ0EB1C103K	B	70.3/107
C245	4030017460	S.CER ECJ0EB1E102K	B	91.5/59.6
C246	4030017580	S.CER ECJ0EC1H060C	B	46.9/113.5
C247	4030017460	S.CER ECJ0EB1E102K	B	43.1/109.5
C248	4030017460	S.CER ECJ0EB1E102K	B	36/117.8
C249	4030017420	S.CER ECJ0EC1H470J	B	48.1/109.7
C250	4030017380	S.CER ECJ0EC1H050B	B	103.7/58.0
C251	4030017580	S.CER ECJ0EC1H060C [Low band]	B	102.6/55.9
	4030017600	S.CER ECJ0EC1H080C [High band]	B	102.6/55.9
	4030017460	S.CER ECJ0EB1E102K	B	100.5/50
C252	4030017380	S.CER ECJ0EC1H050B	B	48/116.2
C254	4030017460	S.CER ECJ0EB1E102K	B	103.7/53.4
C255	4030016930	S.CER ECJ0EB1A104K	T	42.1/50.6
C256	4030017640	S.CER ECJ0EC1H150J	T	43.1/55
C257	4030016790	S.CER ECJ0EB1C103K	T	34.5/58.8
C258	4030017580	S.CER ECJ0EC1H060C [Low band]	B	59.6/117.8
	4030017620	S.CER ECJ0EC1H100C [High band]	B	59.6/117.8
	4030017580	S.CER ECJ0EC1H060C	B	48.5/46.4
C260	4030017460	S.CER ECJ0EB1E102K	B	46.5/105.4
C262	4030016930	S.CER ECJ0EB1A104K	T	69.2/57.5
C263	4030017420	S.CER ECJ0EC1H470J	B	60.5/126.1
C264	4030017460	S.CER ECJ0EB1E102K	B	101.9/50
C265	4030017460	S.CER ECJ0EB1E102K	B	43.5/120.7
C266	4030018900	S.CER ECJ0EB0J474K	T	43.9/45.6
C267	4030017390	S.CER ECJ0EC1H180J [High band]	B	59.6/119.3
	4030017630	S.CER ECJ0EC1H120J [Low band]	B	59.6/119.3
C268	4030017420	S.CER ECJ0EC1H470J	B	62.3/126.1
C269	4550006780	S.TAN TEESVB2 QJ 476M8R	T	71.8/60.8
C270	4030016930	S.CER ECJ0EB1A104K	T	40.5/49.7
C271	4030017350	S.CER ECJ0EC1H020B	B	68.1/137.9
C272	4030017630	S.CER ECJ0EC1H120J	B	47.3/60.1
C274	4030017460	S.CER ECJ0EB1E102K	B	44.4/120.7
C275	4030017580	S.CER ECJ0EC1H060C [High band]	B	48/124.4
	4030017620	S.CER ECJ0EC1H100C [Low band]	B	48/124.4
C276	4030017530	S.CER ECJ0EC1H0R5B [Low band]	B	67.2/137.9
C277	4030016790	S.CER ECJ0EB1C103K	T	48.6/36.7
C279	4030017580	S.CER ECJ0EC1H060C [Low band]	B	59.6/120.9
	4030017620	S.CER ECJ0EC1H100C [High band]	B	59.6/120.9
	4030017460	S.CER ECJ0EB1E102K	B	98.9/66.3
C281	4030017460	S.CER ECJ0EB1E102K	B	100/62
C282	4030017580	S.CER ECJ0EC1H060C [High band]	B	61.4/122.2
	4030017620	S.CER ECJ0EC1H100C [Low band]	B	61.4/122.2
C283	4030017620	S.CER ECJ0EC1H100C	B	103.7/65.9

[MAIN UNIT]

REF NO.	ORDER NO.	DESCRIPTION	M.	H/V LOCATION
C285	4030017580	S.CER ECJ0EC1H060C [High band]	B	66.1/137.9
	4030017620	S.CER ECJ0EC1H100C [Low band]	B	66.1/137.9
C286	4030017530	S.CER ECJ0EC1H0R5B	B	64.5/139.2
C287	4030017350	S.CER ECJ0EC1H020B [Low band]	B	61.8/134.7
	4030017550	S.CER ECJ0EC1H1R5B [High band]	B	61.8/134.7
C291	4030017340	S.CER ECJ0EC1H010B	B	102.4/66.6
C292	4030017460	S.CER ECJ0EB1E102K	B	65/136.3
C293	4030017580	S.CER ECJ0EC1H060C [High band]	B	62.9/137.9
	4030017620	S.CER ECJ0EC1H100C [Low band]	B	62.9/137.9
C294	4030017530	S.CER ECJ0EC1H0R5B	B	58.3/138.5
C295	4030017460	S.CER ECJ0EB1E102K	B	65/134.7
C296	4030017580	S.CER ECJ0EC1H060C [High band]	B	56.1/138
	4030017620	S.CER ECJ0EC1H100C [Low band]	B	56.1/138
C298	4030017460	S.CER ECJ0EB1E102K	B	136.2/82.9
C299	4030017460	S.CER ECJ0EB1E102K	B	50.4/133.8
C300	4030017460	S.CER ECJ0EB1E102K	B	54.1/133.9
C301	4030016790	S.CER ECJ0EB1C103K	B	51.4/133.8
C302	4030017460	S.CER ECJ0EB1E102K	B	52/138.5
C303	4030017370	S.CER ECJ0EC1H3R5B	B	131.4/82.3
C304	4030017420	S.CER ECJ0EC1H470J	B	136.2/81.9
C305	4030017420	S.CER ECJ0EC1H470J	B	46.4/133.8
C306	4030017460	S.CER ECJ0EB1E102K	B	47.4/133.8
C307	4030017460	S.CER ECJ0EB1E102K	B	45.4/138.3
C309	4030017420	S.CER ECJ0EC1H470J	B	136.8/84.5
C310	4030017370	S.CER ECJ0EC1H3R5B [High band]	B	134.9/85.9
	4030017380	S.CER ECJ0EC1H050B [Low band]	B	134.9/85.9
C311	4030016930	S.CER ECJ0EB1A104K	B	45.4/140.4
C312	4030017420	S.CER ECJ0EC1H470J	B	50.4/140.4
C313	4030016930	S.CER ECJ0EB1A104K	B	46.4/140.4
C314	4030017460	S.CER ECJ0EB1E102K	B	49.4/140.4
C315	4030017730	S.CER ECJ0EB1E471K	B	137.8/84.5
C316	4030017570	S.CER ECJ0EC1H040B	B	130.4/80.9
C321	4030017420	S.CER ECJ0EC1H470J	T	66/57.5
C322	4030017420	S.CER ECJ0EC1H470J	T	67.6/54.3
C323	4030017620	S.CER ECJ0EC1H100C	B	44.4/137.7
C324	4030017520	S.CER ECJ0EC1H0R3B [High band]	B	134.9/88.3
	4030017530	S.CER ECJ0EC1H0R5B [Low band]	B	134.9/88.3
C326	4030017580	S.CER ECJ0EC1H060C [Low band]	B	39.3/138.2
	4030017590	S.CER ECJ0EC1H070C [High band]	B	39.3/138.2
C327	4030017350	S.CER ECJ0EC1H020B [EUR-01]	B	141.8/89.2
	4030017360	S.CER ECJ0EC1H030B except [EUR-01]	B	141.8/89.2
C328	4030017420	S.CER ECJ0EC1H470J	B	140.9/85.4
C329	4030017390	S.CER ECJ0EC1H180J [High band]	B	38.4/133.5
	4030017410	S.CER ECJ0EC1H240J [Low band]	B	38.4/133.5
C330	4030017460	S.CER ECJ0EB1E102K	B	139.9/85.4
C331	4030017460	S.CER ECJ0EB1E102K	B	59.2/140.4
C332	4030018860	S.CER ECJ0EB0J105K	B	55/140.4
C333	4030016930	S.CER ECJ0EB1A104K	T	23.1/29.4
C335	4030017550	S.CER ECJ0EC1H1R5B	B	144/89.5
C336	4030018860	S.CER ECJ0EB0J105K	B	60.1/140.4
C337	4030017580	S.CER ECJ0EC1H060C	B	142.6/91.7
C338	4030017550	S.CER ECJ0EC1H1R5B	B	39.3/139.1
C339	4030017460	S.CER ECJ0EB1E102K	B	32.5/134
C340	4030016930	S.CER ECJ0EB1A104K	T	54/20.3
C341	4030017420	S.CER ECJ0EC1H470J	T	143.1/123.3
C342	4030017730	S.CER ECJ0EB1E471K	T	138.8/108
C345	4030017460	S.CER ECJ0EB1E102K	B	30.6/135.9
C346	4030017420	S.CER ECJ0EC1H470J	T	63.1/57.2
C347	4030017460	S.CER ECJ0EB1E102K	T	143.1/124.2
C348	4030017420	S.CER ECJ0EC1H470J	T	63.8/55.2
C349	4030017580	S.CER ECJ0EC1H060C	B	143.5/95.2
C350	4030017420	S.CER ECJ0EC1H470J	T	138.7/112.3
C351	4030017460	S.CER ECJ0EB1E102K	T	138.7/113.2
C352	4030017390	S.CER ECJ0EC1H180J [High band]	B	31.6/137.9
	4030017410	S.CER ECJ0EC1H240J [Low band]	B	31.6/137.9
C353	4030017460	S.CER ECJ0EB1E102K	T	140.4/118.8
C354	4030017420	S.CER ECJ0EC1H470J	T	106.6/115.9
C355	4030017580	S.CER ECJ0EC1H060C [Low band]	B	37.5/136.8
	4030017590	S.CER ECJ0EC1H070C [High band]	B	37.5/136.8
C357	4030017630	S.CER ECJ0EC1H120J	B	39.3/140
C358	4030016790	S.CER ECJ0EB1C103K	T	137.5/128.2
C359	4510009550	S.ELE EEEFK1C100R	T	107.2/86.5
C360	4030017460	S.CER ECJ0EB1E102K	T	106.6/116.8
C361	4030011030	S.CER GRM31M4C2H1R5CY21L [EUR-01] only	B	100.2/115.8
C362	4030017510	S.CER ECJ0EC1H680J	B	39.7/144.6
C364	4030011020	S.CER GRM31M4C2H1R0CY21L	B	89.8/119.8
C365	4030017730	S.CER ECJ0EB1E471K	T	106.6/117.7
C366	4030016970	S.CER ECJ0EB1C223K	T	142.4/126.6
C367	4510009810	S.ELE EEEFK1E220R	T	107.3/95.1
C368	4030006860	S.CER C1608 JB 1H 102K-T	T	89.1/142
C369	4030017460	S.CER ECJ0EB1E102K	B	33.4/134
C370	4030011060	S.CER GRM31M2C2H4R0CY21L except [EUR-01]	B	100.2/123.1
	4030011070	S.CER GRM31M		



[MAIN UNIT]

REF NO.	ORDER NO.	DESCRIPTION	M.	H/V LOCATION
C393	4030011050	S.CER GRM31M3C2H3R0CY21L	B	98.4/126.8
C394	4550006250	S.TAN TEESVA 1A 106M8R	B	26.3/15.3
C395	4030011050	S.CER GRM31M3C2H3R0CY21L	B	100.5/126.9
C396	4510009550	S.ELE EEEFK1C100R	T	97/77.8
C397	4030017460	S.CER ECJ0EB1E102K	T	137.4/118.5
C398	4550006250	S.TAN TEESVA 1A 106M8R	B	31.7/15.5
C399	4030017460	S.CER ECJ0EB1E102K	T	100/76.1
C400	4030017460	S.CER ECJ0EB1E102K	B	86.2/129.8
C401	4030011080	S.CER GRM31M2C2H6R0DV01L	B	103.2/130.9
C402	4030016930	S.CER ECJ0EB1A104K	T	47.2/71.6
C403	4030011050	S.CER GRM31M3C2H3R0CY21L	B	106.2/130.9
C404	4030017460	S.CER ECJ0EB1E102K	T	140.7/129.2
C405	4030017420	S.CER ECJ0EC1H470J	B	56.7/55.3
C406	4030016790	S.CER ECJ0EB1C103K	T	103.5/76.2
C407	4030011030	S.CER GRM31M4C2H1R5CY21L	B	102.6/137.2
C408	4030017460	S.CER ECJ0EB1E102K	B	98.1/138.5
C409	4030011050	S.CER GRM31M3C2H3R0CY21L	B	110.9/136
C410	4030011050	S.CER GRM31M3C2H3R0CY21L	B	113/134
C411	4550007650	S.TAN F931V105MAABMA	T	37.5/68.6
C412	4030017460	S.CER ECJ0EB1E102K	T	112.6/78.5
C413	4030016930	S.CER ECJ0EB1A104K	T	38.5/71.9
C414	4030017420	S.CER ECJ0EC1H470J	B	29.7/135.9
C415	4550007650	S.TAN F931V105MAABMA	T	37.5/63.4
C416	4550006250	S.TAN TEESVA 1A 106M8R	T	107.8/81.5
C417	4030016930	S.CER ECJ0EB1A104K	T	15/125.7
C418	4550007650	S.TAN F931V105MAABMA	T	39.4/73.9
C419	4030011050	S.CER GRM31M3C2H3R0CY21L except [EUR-01]	B	115.7/134
	4030011080	S.CER GRM31M2C2H6R0DV01L [EUR-01]	B	115.7/134
C420	4030016930	S.CER ECJ0EB1A104K	B	27.4/18.5
C422	4030006860	S.CER C1608 JB 1H 102K-T	B	119.5/139.5
C423	4030017460	S.CER ECJ0EB1E102K	B	119.4/145.9
C424	4030016930	S.CER ECJ0EB1A104K	T	14.1/125.7
C426	4030009530	S.CER C1608 CH 1H 030B-T except [EUR-01]	B	120.8/139.5
	4030009540	S.CER C1608 CH 1H 1R5B-T [EUR-01]	B	120.8/139.5
C431	4030018860	S.CER ECJ0EB0J105K	B	33.3/13.6
C432	4030016930	S.CER ECJ0EB1A104K	T	10.8/120.6
C433	4030006860	S.CER C1608 JB 1H 102K-T	B	139.5/137.7
C434	4030017460	S.CER ECJ0EB1E102K	B	140.5/131
C435	4030017460	S.CER ECJ0EB1E102K	T	54.8/29.8
C436	4030011040	S.CER GRM31M4C2H2R0CY21L [EUR-01]	B	144.8/138.6
	4030011050	S.CER GRM31M3C2H3R0CY21L except [EUR-01]	B	144.8/138.6
C437	4030016930	S.CER ECJ0EB1A104K	T	34.4/12
C438	4030016790	S.CER ECJ0EB1C103K	T	112.8/88.2
C439	4510009810	S.ELE EEEFK1E220R	T	128.4/89.8
C440	4030018900	S.CER ECJ0EB0J474K	T	7.9/129.6
C441	4030017440	S.CER ECJ0EC1H221J	T	12/126.2
C442	4510008780	S.ELE EEE1EA471P	B	9.6/119.8
C443	4030017460	S.CER ECJ0EB1E102K	T	111.9/88.2
C444	4030011060	S.CER GRM31M2C2H4R0CY21L [EUR-01]	B	147/148.9
	4030011070	S.CER GRM31M2C2H5R0CY21L except [EUR-01]	B	147/148.9
C446	4030017460	S.CER ECJ0EB1E102K	T	6.6/130.1
C448	4030017460	S.CER ECJ0EB1E102K	T	128.8/102.4
C449	4510008870	S.ELE EEE1AA471UP	B	8.9/139.2
C450	4030016930	S.CER ECJ0EB1A104K	T	7/125.3
C451	4030018860	S.CER ECJ0EB0J105K	T	8.6/125.3
C452	4030018860	S.CER ECJ0EB0J105K	T	72/98.2
C453	4030017460	S.CER ECJ0EB1E102K	T	130.8/103.6
C454	4030017430	S.CER ECJ0EC1H101J	B	46.3/56.9
C458	4030017460	S.CER ECJ0EB1E102K	T	114.8/95.7
C459	4030017460	S.CER ECJ0EB1E102K	T	116.3/119.1
C460	4030017460	S.CER ECJ0EB1E102K	B	9.6/147.3
C461	4030017420	S.CER ECJ0EC1H470J	T	114.8/94.8
C462	4030017420	S.CER ECJ0EC1H470J	T	115.3/119.1
C463	4030017420	S.CER ECJ0EC1H470J	B	9.6/146.4
C464	4510009680	S.ELE EEEFK1E471P	B	144.4/121.1
C465	4550006250	S.TAN TEESVA 1A 106M8R	T	102.7/92
C466	4030017420	S.CER ECJ0EC1H470J	T	99.9/88
C467	4030016930	S.CER ECJ0EB1A104K	T	62.3/58.5
C468	4030016930	S.CER ECJ0EB1A104K	T	61.7/56.9
C470	4030018860	S.CER ECJ0EB0J105K	T	7.4/122.3
C471	4030016790	S.CER ECJ0EB1C103K	T	7/124.4
C472	4030018860	S.CER ECJ0EB0J105K	T	10.9/117.7
C473	4030018860	S.CER ECJ0EB0J105K	T	5/118.9
C474	4030017780	S.CER ECJ0EB1E472K	T	115.3/17.6
C475	4510008120	S.ELE 16 CE 100 BS	T	125.1/12.1
C476	4510008120	S.ELE 16 CE 100 BS	T	125.1/19.3
C477	4030017780	S.CER ECJ0EB1E472K	T	119/12.3
C478	4030017780	S.CER ECJ0EB1E472K	T	115.3/12.2
C479	4510008120	S.ELE 16 CE 100 BS	T	104.8/14.3
C481	4030017460	S.CER ECJ0EB1E102K	B	63.2/122.2
C491	4030016930	S.CER ECJ0EB1A104K	B	6.0/60.1
C492	4030016930	S.CER ECJ0EB1A104K	B	13.5/32.6
C493	4510008870	S.ELE EEE1AA471UP	B	66.3/45.3
C494	4030016930	S.CER ECJ0EB1A104K	T	117.2/92.6
C495	4030016930	S.CER ECJ0EB1A104K	T	117.2/90.7
C496	4030016930	S.CER ECJ0EB1A104K	T	122.4/92.2
C497	4030016930	S.CER ECJ0EB1A104K	T	109.7/82
C498	4030016930	S.CER ECJ0EB1A104K	T	11.4/43.2
C501	4030017420	S.CER ECJ0EC1H470J	T	12.2/31.2
C502	4030017420	S.CER ECJ0EC1H470J	T	29.5/2.8
C503	4030017420	S.CER ECJ0EC1H470J	T	48/99.4
C506	4030016930	S.CER ECJ0EB1A104K	B	26.3/43.3
C507	4030016930	S.CER ECJ0EB1A104K	B	32.9/31
C508	4030016930	S.CER ECJ0EB1A104K	B	40.1/42.7
C509	4030016930	S.CER ECJ0EB1A104K	B	26.2/39
C510	4030016930	S.CER ECJ0EB1A104K	B	26.6/33
C511	4030016930	S.CER ECJ0EB1A104K	B	40.1/34.2

[MAIN UNIT]

REF NO.	ORDER NO.	DESCRIPTION	M.	H/V LOCATION
C512	4030017420	S.CER ECJ0EC1H470J	T	92/14.7
C513	4550006250	S.TAN TEESVA 1A 106M8R	B	8.4/59.8
C514	4030016930	S.CER ECJ0EB1A104K	B	11.7/53.5
C515	4030016930	S.CER ECJ0EB1A104K	B	15.5/54.4
C516	4030016930	S.CER ECJ0EB1A104K	T	65.1/69.6
C517	4030016930	S.CER ECJ0EB1A104K	B	15.6/63.1
C518	4030016930	S.CER ECJ0EB1A104K	B	12.4/62.4
C519	4030017460	S.CER ECJ0EB1E102K	B	15.6/59.9
C521	4030016930	S.CER ECJ0EB1A104K	B	18.1/53.6
C522	4030016930	S.CER ECJ0EB1A104K	T	51.2/31.8
C523	4030016930	S.CER ECJ0EB1A104K	T	51.2/33
C524	4030018910	S.CER C1608 JB 0J 475K-T	T	9.5/56
C525	4030018910	S.CER C1608 JB 0J 475K-T	B	25.8/58.3
C526	4030017730	S.CER ECJ0EB1E471K	B	29.8/57.3
C527	4030016790	S.CER ECJ0EB1C103K	B	26.1/50.3
C528	4030017670	S.CER ECJ0EC1H390J	B	37.4/120.7
C529	4030017630	S.CER ECJ0EC1H120J	B	38.3/112.2
C530	4030017420	S.CER ECJ0EC1H470J	T	60.4/62.3
C531	4030017670	S.CER ECJ0EC1H390J	B	93.3/62
C532	4030017670	S.CER ECJ0EC1H390J	B	93.6/52.9
C533	4510008120	S.ELE 16 CE 100 BS	T	125.1/26.4
C534	4030016790	S.CER ECJ0EB1C103K	T	118.5/26.7
C535	4030016790	S.CER ECJ0EB1C103K	B	67.4/101.6
C536	4030016790	S.CER ECJ0EB1C103K	B	65.7/98.3
C538	4030006860	S.CER C1608 JB 1H 102K-T	T	36.2/145.1
C539	4030017790	S.CER ECJ0EB1E682K	T	22.8/57
C540	4030017730	S.CER ECJ0EB1E471K	T	21.2/56.6
C541	4030016930	S.CER ECJ0EB1A104K	T	22.8/55.4
C542	4030017440	S.CER ECJ0EC1H221J	T	27.1/55
C543	4030016930	S.CER ECJ0EB1A104K	T	56.5/68.9
C544	4030017460	S.CER ECJ0EB1E102K	T	62.4/72.9
C545	4030011040	S.CER GRM31M4C2H2R0CY21L [High band]	T	97.6/106.8
	4030011060	S.CER GRM31M2C2H4R0CY21L [Low band]	T	97.6/106.8
C546	4030018910	S.CER C1608 JB 0J 475K-T	B	40.4/56.7
C547	4030017760	S.CER ECJ0EB1H222K	T	53.7/72.1
C548	4030016930	S.CER ECJ0EB1A104K	T	14.1/120.6
C549	4030017420	S.CER ECJ0EC1H470J	T	23.1/86.8
C550	4030017420	S.CER ECJ0EC1H470J	T	70.1/82.6
C551	4030017330	S.CER ECJ0EF1C104Z	T	114.2/28.9
C552	4030016790	S.CER ECJ0EB1C103K	B	121.9/48.8
C553	4030016930	S.CER ECJ0EB1A104K	B	30.8/19.4
C555	4030016930	S.CER ECJ0EB1A104K	B	69.8/75.5
C556	4030016930	S.CER ECJ0EB1A104K	T	105.2/28.6
C557	4030016930	S.CER ECJ0EB1A104K	T	97/28.6
C558	4550006250	S.TAN TEESVA 1A 106M8R	T	95.1/27.9
C559	4550007080	S.TAN TEESVA 1C 106M8R	T	45.9/75.5
C562	4030017420	S.CER ECJ0EC1H470J	T	38.5/76.1
C563	4030016930	S.CER ECJ0EB1A104K	B	26.5/122.3
C564	4030017570	S.CER ECJ0EC1H040B	B	68.3/131.3
C565	4030017340	S.CER ECJ0EC1H010B	B	47.9/113.5
C566	4030018860	S.CER ECJ0EB0J105K	B	39/72.7
C571	4030017580	S.CER ECJ0EC1H060C	T	64.6/99.1
C572	4030017580	S.CER ECJ0EC1H060C	T	65.6/99.1
C573	4030017580	S.CER ECJ0EC1H060C	T	65.3/97.4
C574	4030017580	S.CER ECJ0EC1H060C	B	64/134.7
C575	4030017420	S.CER ECJ0EC1H470J	B	62.9/132.4
C576	4030017460	S.CER ECJ0EB1E102K	T	67.1/106.5
C577	4030017460	S.CER ECJ0EB1E102K	T	67.1/104.9
C578	4030017200	S.CER GRM31BR32J102KY01L	T	92/126
C579	4550006250	S.TAN TEESVA 1A 106M8R	B	94.7/50.6
C580	4030017420	S.CER ECJ0EC1H470J	T	100.7/73.5
C581	4030018910	S.CER C1608 JB 0J 475K-T	B	46.3/60.9
C582	4030018910	S.CER C1608 JB 0J 475K-T	T	69.7/98.2
C583	4030016930	S.CER ECJ0EB1A104K	B	46.3/58.6
C584	4030016790	S.CER ECJ0EB1C103K	B	54.9/55.3
C585	4030016930	S.CER ECJ0EB1A104K	B	54.9/58.6
C586	4030017730	S.CER ECJ0EB1E471K	B	54.9/56.9
C587	4030016790	S.CER ECJ0EB1C103K	B	52.3/59.8
C588	4030018910	S.CER C1608 JB 0J 475K-T	T	70.9/98.2
C601	4030011060	S.CER GRM31M2C2H4R0CY21L except [EUR-01]	T	97.6/111.3
	4030011070	S.CER GRM31M2C2H5R0CY21L [EUR-01]	T	97.6/111.3
C610	4030018080	S.CER ECJ0EB1H182K	T	63.3/69.6
C612	4030017460	S.CER ECJ0EB1E102K	B	55.7/29.9
C614	4030017730	S.CER ECJ0EB1E471K	B	29/13.2
C615	4030017650	S.CER ECJ0EC1H270J	B	63.2/117.5
C616	4030017460	S.CER ECJ0EB1E102K	T	93.8/64.6
C617	4030017420	S.CER ECJ0EC1H470J	T	60/64.8
C618	4030017420	S.CER ECJ0EC1H470J	T	64.9/53.3
C619	4030017420	S.CER ECJ0EC1H470J	T	74.2/107.7
C620	4030017420	S.CER ECJ0EC1H470J	T	73.7/96.8
C621	4030017420	S.CER ECJ0EC1H470J	T	31.5/2.8
C622	4030018910	S.CER C1608 JB 0J 475K-T	T	64.3/73.2
C623	4030017330	S.CER ECJ0EF1C104Z	B	126.8/16
C624	4030017330	S.CER ECJ0EF1C104Z	B	126.3/20.3
C625	4030017460	S.CER ECJ0EB1E102K	B	126.8/17.2
C626	4510009810	S.ELE EEEFK1E220R	B	129.4/23
C630	4030017420	S.CER ECJ0EC1H470J [EUR-01] only	T	106.4/106.8
C631	4030017580	S.CER ECJ0EC1H060C [EUR-01] only	T	113.5/108.

**[MAIN UNIT]**

REF NO.	ORDER NO.	DESCRIPTION	M.	H/V LOCATION
DS1	5040002961	S.LED SML-A12MT T86J	B	96/1.1
DS2	5040002961	S.LED SML-A12MT T86J	B	126/1.1
DS3	5040003000	S.LED SML-A12UT-T86	B	111/1.1
MF1	2710000870	FAN AFB0512HB-7X22 <USE>HK		
W1	7120000470	JMP ERDS2T0		
W2	7120000470	JMP ERDS2T0		
W4	8900017520	CBL OPC-1783		
EP1	6910015370	S.BEA ACZ1005Y-102-T	B	129.1/48.4
EP2	6910015370	S.BEA ACZ1005Y-102-T	B	117.2/48.4
EP3	6910015370	S.BEA ACZ1005Y-102-T	B	32.4/81.6
EP4	6910016330	S.BEA MMZ1005S 601CT-S	B	30.4/60.5
EP5	6910015370	S.BEA ACZ1005Y-102-T	B	39/74.5
EP6	6910015370	S.BEA ACZ1005Y-102-T	B	37.8/109
EP7	6910016330	S.BEA MMZ1005S 601CT-S	B	40.7/36.7
EP8	6910015370	S.BEA ACZ1005Y-102-T	B	94.5/48.8
EP9	6910016330	S.BEA MMZ1005S 601CT-S	T	48.8/39.3
EP10	6910011560	BEA HF70BB4.5X5X1.6		
EP11	6910010280	BEA HF70BB9.5X10.4X4.9		
EP12	6910010280	BEA HF70BB9.5X10.4X4.9		
EP13	6910011330	TER OT-009 M3		
EP14	6910011330	TER OT-009 M3		

**[CONNECT UNIT]**

REF NO.	ORDER NO.	DESCRIPTION	M.	H/V LOCATION
C601	4030017420	S.CER ECJ0EC1H470J	T	13.8/12.4
C602	4030017400	S.CER ECJ0EC1H220J	T	12.2/12.4
C603	4030017420	S.CER ECJ0EC1H470J	T	16.5/12.4
C604	4030017400	S.CER ECJ0EC1H220J	T	15/14.2
C605	4030017420	S.CER ECJ0EC1H470J	T	17.8/13.9
C606	4030017420	S.CER ECJ0EC1H470J	T	19.4/12.4
C607	4030017420	S.CER ECJ0EC1H470J	T	20.5/13.9
C608	4030017420	S.CER ECJ0EC1H470J	T	22.6/12.4
C609	4030017420	S.CER ECJ0EC1H470J	T	25.5/12.4
C610	4030017420	S.CER ECJ0EC1H470J	T	29.7/12.8
C611	4030017420	S.CER ECJ0EC1H470J	T	31/14.1
C612	4030017420	S.CER ECJ0EC1H470J	T	32.4/12.8
C613	4030017420	S.CER ECJ0EC1H470J	T	33.5/14.1
C614	4030017420	S.CER ECJ0EC1H470J	T	35.2/14.1
C615	4030017420	S.CER ECJ0EC1H470J	T	35.7/12.8
C616	4030017420	S.CER ECJ0EC1H470J	B	35.2/15.6
C617	4030017420	S.CER ECJ0EC1H470J	T	37.5/13.5
C618	4030017420	S.CER ECJ0EC1H470J	T	39.3/12.2
C619	4030017420	S.CER ECJ0EC1H470J	T	39.9/13.4
C620	4030017420	S.CER ECJ0EC1H470J	T	41.3/12.6
C621	4030017420	S.CER ECJ0EC1H470J	T	27.4/13.9
J601	6510026290	S.CNR IMSA-9631S-28Y921	B	22.8/16.2
J602	6510023210	CNR CD6125SA1J0 <CVI>		
S1	2260003070	S.SW MINISMDC150F/24-2	B	38.9/18
W601	8900017500	CBL OPC-1852 (P0.5,N28,L90) <TJM>		

M.=Mounted side (T: Mounted on the Top side, B: Mounted on the Bottom side)  
S.=Surface mount



# SECTION 8

# MECHANICAL PARTS

## [MAIN UNIT]

REF NO.	ORDER NO.	DESCRIPTION	QTY.
J1*	6510025220	AXK540145J	1
J2*	6510023091	20FLT-SM2-TB (LF) (SN)	1
J4*	6510023511	28FLT-SM2-TB (LF) (SN)	1
J5	6510023110	3008L-8P8C	1
J6	6450000140	HSJ0807-01-010	1
J8*	6510023091	20FLT-SM2-TB (LF) (SN)	1
J9*	6510019371	B3B-ZR-SM4-TF (LF) (SN)	1
J10	6510004910	NR-DSE-01	1
J11	6510004910	NR-DSE-01	1
MF1	2710000870	AFB0512HB-F00	1
W1	7120000470	ERDS2T0	1
W2	7120000470	ERDS2T0	1
W4	8900017520	OPC-1783	1
EP10*	6910011560	HF70BB4.5X5X1.6	2
EP11*	6910010280	HF70BB9.5X10.4X4.9	1
EP12*	6910010280	HF70BB9.5X10.4X4.9	1
EP13	6910011330	OT-009 M3	1
EP14	6910011330	OT-009 M3	1
MP1	8510018070	2979 VCO CASE	1
MP2	8510018060	2979 VCO COVER	1
MP3	8510018070	2979 VCO CASE	1
MP4	8510018060	2979 VCO COVER	1
MP5	8210024440	3063 SUB M-PANEL	1
MP6	8310070880	3063 S-LED PLATE	1
MP7	8930073920	3063 SP COVER	1
MP8	8010020980	3063 CHASSIS	1
MP9	8110009360	3063 SU-COVER	1
MP10	8110009370	3063 SL-COVER	1
MP11	8930074300	3063 PC PLATE	1
MP12	8930074180	O-RING (BR)	1
MP13	8930075020	3063 B-PACKING	1
MP14	8930075030	3063 C-PACKING	1
MP15	8930073930	3063 SP RUBBER	1
MP16	8930058990	SHIELD SPONGE (V)	1
MP17	8930062160	HIMELON SHEET (CL)	1
MP18	8930070921	2979 D-SUB PLATE-1	1
MP19	8930058990	SHIELD SPONGE (V)	1
MP20*	8510015660	2681 F-SHIELD PLATE	1
MP21	8930048550	2177 CLIP	1
MP23	8930075080	DUST CAP HR25F	1
MP24	8810009611	SCREW M2.6X6 ZK3	8
MP25	8810009611	SCREW M2.6X6 ZK3	9
MP26	8810010780	SCREW BT B0 3X20NI-ZK3 (BT)	4
MP27	8810008661	SCREW BT B0 3X8 NI-ZC3 (BT)	19
MP28	8810008661	SCREW BT B0 3X8 NI-ZC3 (BT)	2
MP29	8810008661	SCREW BT B0 3X8 NI-ZC3 (BT)	1
MP30	8810008661	SCREW BT B0 3X8 NI-ZC3 (BT)	2
MP31	8810008661	SCREW BT B0 3X8 NI-ZC3 (BT)	3
MP32	8810008661	SCREW BT B0 3X8 NI-ZC3 (BT)	4
MP33*	8510018780	3063 ANT CASE	2
MP35	8810003361	SETSCREW (C) 3X6 ZC3	2
MP37	8510018790	3063 VCO SHIELD	1
MP38*	8510018820	3063 SHIELD PLATE	1

## [ACCESSORIES]

REF NO.	ORDER NO.	DESCRIPTION	QTY.
W1	8900017530	OPC-1784	1
W2	8900017540	OPC-1785	1
MP1	8930073980	3063 ANGLE	2
MP2	8810008661	SCREW BT B0 3X8 NI-ZC3 (BT)	2
MP3	8810003361	SETSCREW (C) 3X6 ZC3	4
MP4	8810008451	SCREW BiH M4X8 ZK3	4

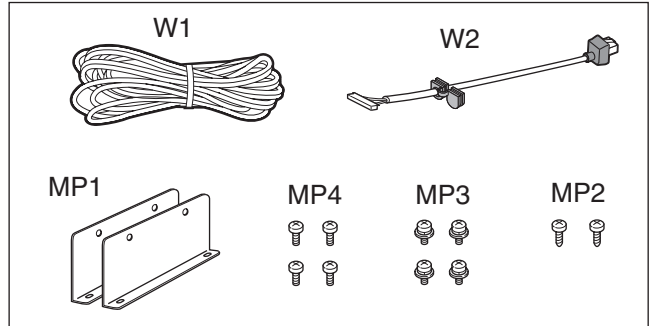

## [CONNECT UNIT]

REF NO.	ORDER NO.	DESCRIPTION	QTY.
J601*	6510026290	IMS A-9631S-28Y921	1
J602	6510023210	CD6125SA1J0	1
S1*	2260003070	MINISMDC150F/24	1
W601	8900017500	OPC-1852	1

\*: Refer to "BOARD LAYOUTS" for the location.

**Screw abbreviations** A, B0, BT: Self-tapping PH: Pan head ZK: Black NI-ZU: Nickel-Zinc SUS: Stainless

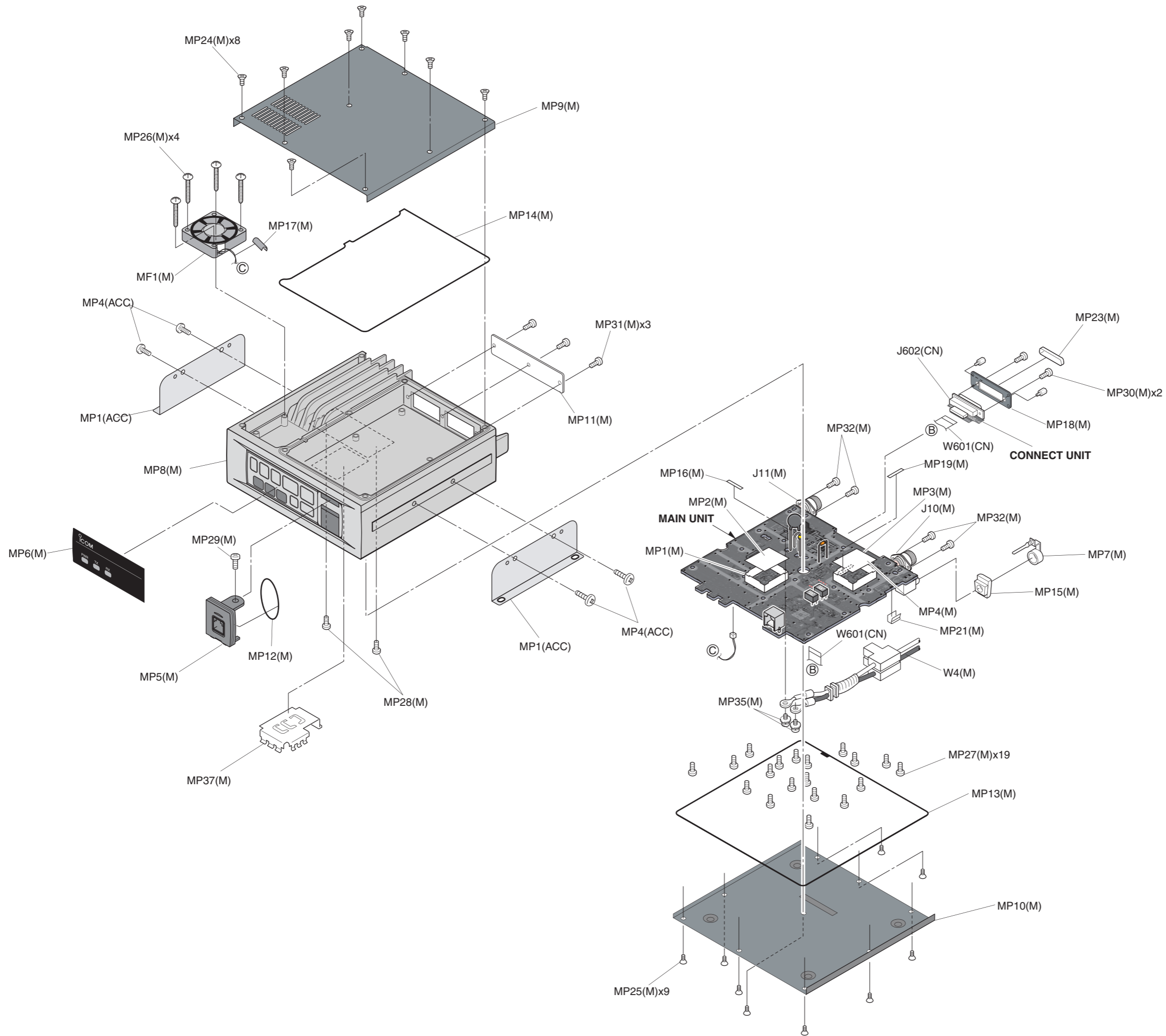

**Unit abbreviations;**  
 (C) : CHASSIS PARTS  
 (F) : FRONT UNIT  
 (M) : MAIN UNIT  
 (CN) : CONNECTOR UNIT  
 (ACC) : ACCESSORY







# SECTION 10

# BLOCK DIAGRAM

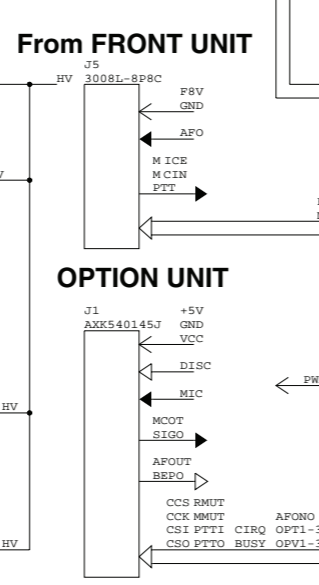
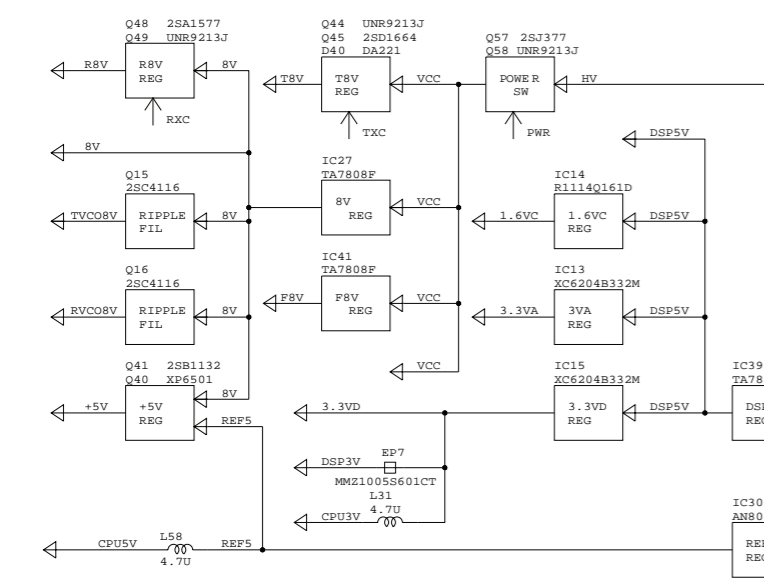
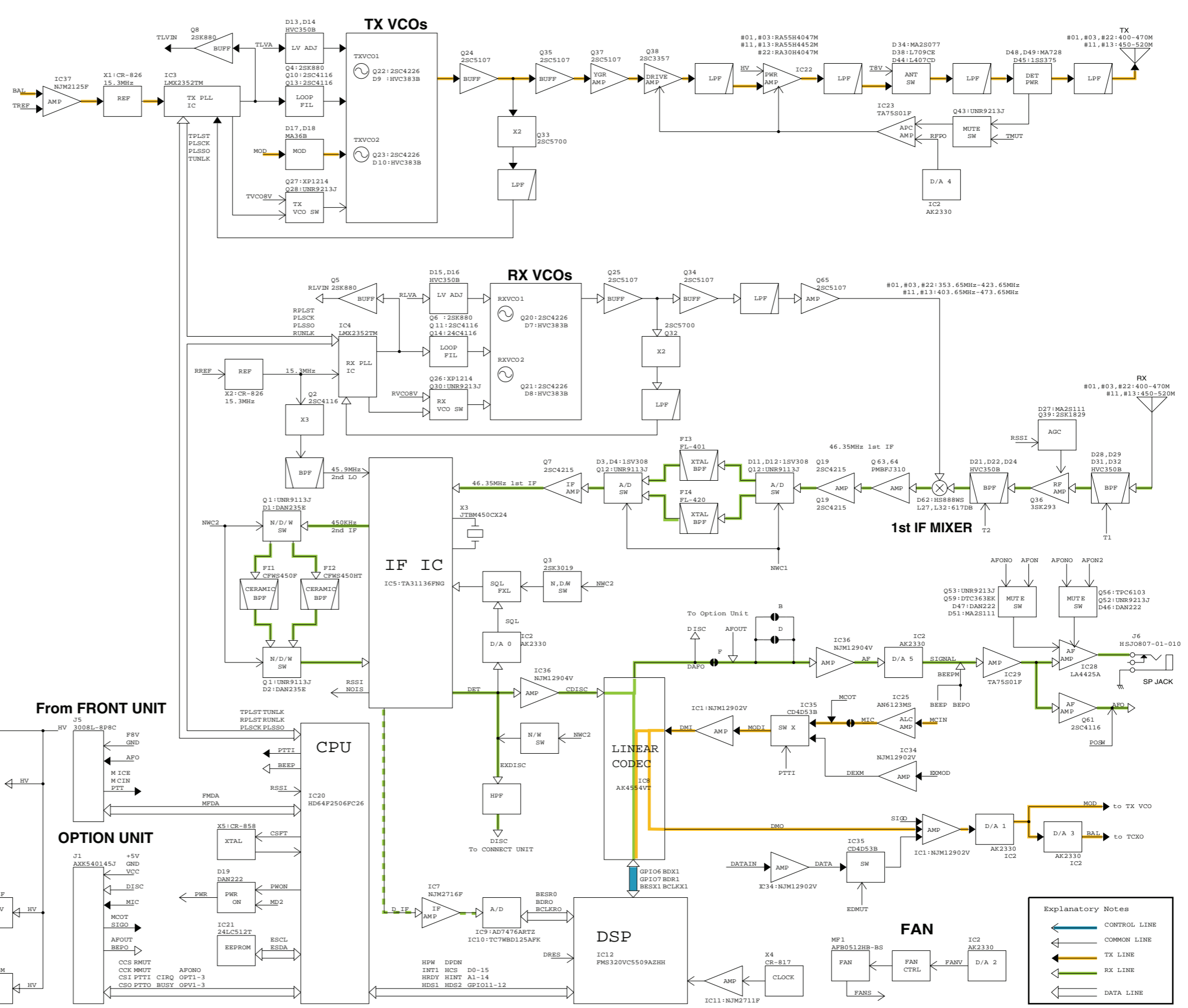
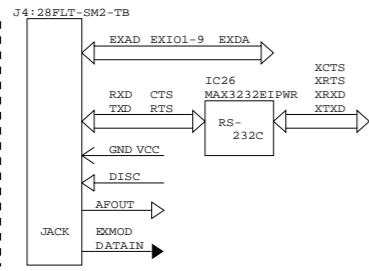
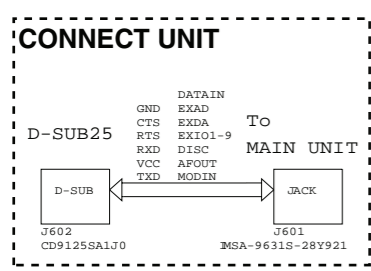

Explanatory Notes	
	CONTROL LINE
	COMMON LINE
	TX LINE
	RX LINE
	DATA LINE





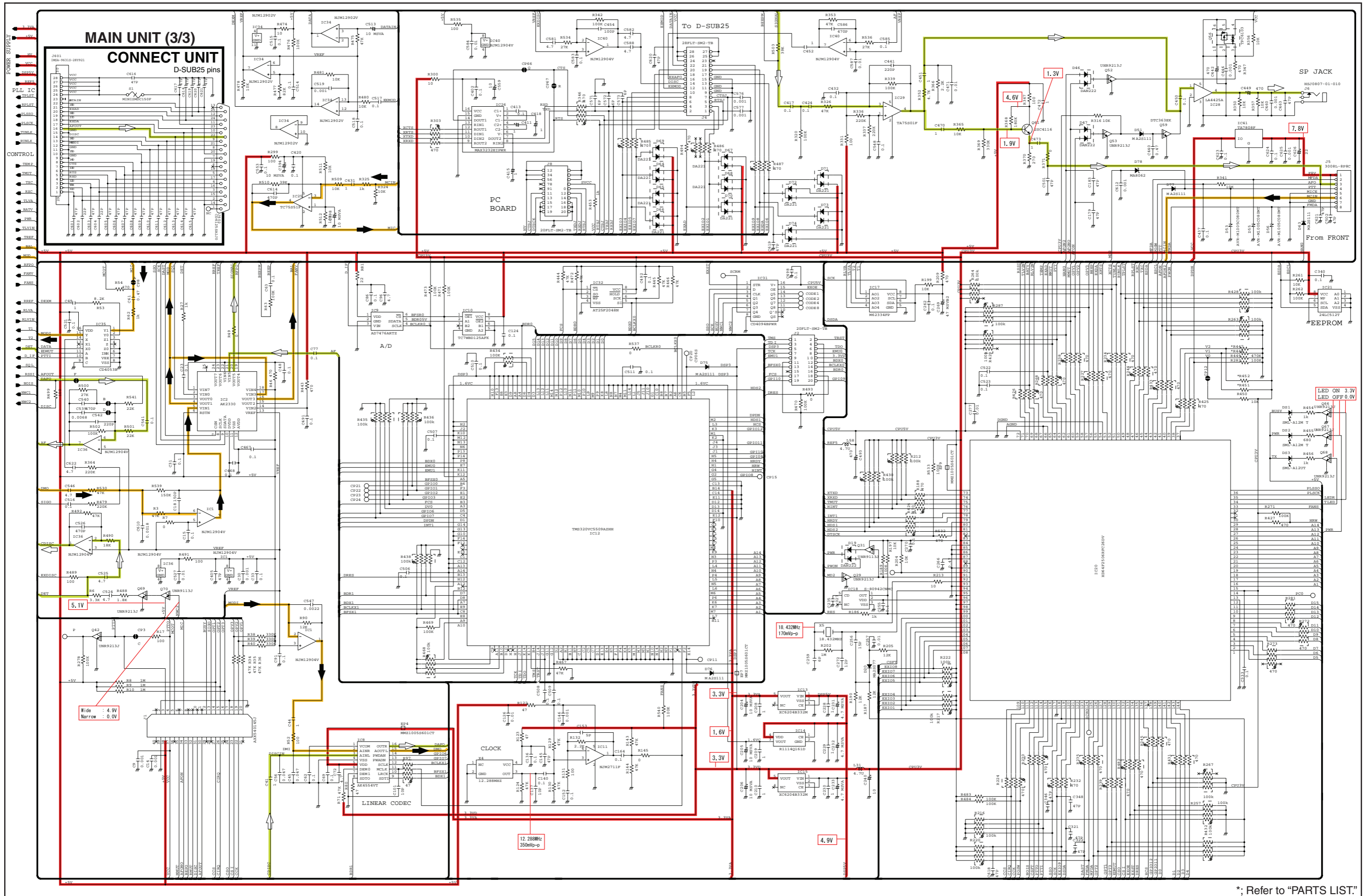

\*; Refer to "PARTS LIST"



• ACCESSORY CONNECTOR (CONNECT UNIT) INFORMATION

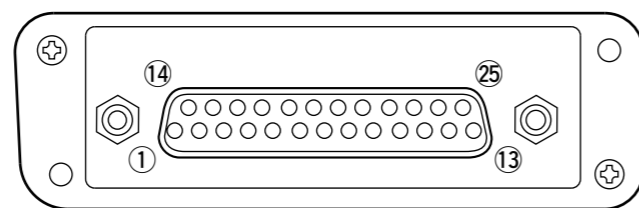
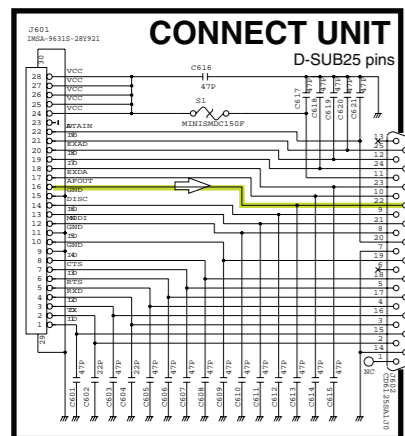

Pin No.	Pin Name	Description	Specification
1	NC	No connection	—
2	TXD	Output terminal for serial communication data.	—
3	RXD	Input terminal for serial communication data.	—
4	RTS	Output terminal for request-to-send data.	—
5	CTS	Input terminal for clear-to-send data.	—
6	NC	No connection	—
7	GND	Serial/digital signal ground	—
8	MOD IN	Modulator input from an external terminal unit.	Input level: 300 mV rms
9	DISC OUT	Output terminal for AF signals from the AF detector circuit. Output level is fixed, regardless of [AF] control.	Output level: 300 mV rms
10	EXT. D/A	The desired function can be assigned.* (Default: Null)	—
11	VCC	13.6 V DC output	Output current: Less than 1 A
12	EXT. A/D	Customize A/D input (Not used)	—
13	NC	No connection	—
14	GND	Ground	—
15	EXT./O 15	The desired function can be assigned.* (Default: Null)	+5 V pull up, Active=L
16	EXT./O 16	The desired function can be assigned.* (Default: P0 Monitor Output)	+5 V pull up, Active=L
17	EXT./O 17	The desired function can be assigned.* (Default: Busy Output)	+5 V pull up, Active=L
18	EXT./O 18	The desired function can be assigned.* (Default: Null)	+5 V pull up, Active=L
19	EXT./O 19	The desired function can be assigned.* (Default: EPTT Input)	+5 V pull up, Active=L
20	DATA IN	Input terminal for data.	—
21	EXT./O 21	The desired function can be assigned.* (Default: Analog Audible Output)	+5 V pull up, Active=L
22	AF OUT	The AF detector Output.	—
23	EXT./O 23	The desired function can be assigned.* (Default: Mic Mute Output)	+5 V pull up, Active=L
24	EXT./O 24	The desired function can be assigned.* (Default: Null)	+5 V pull up, Active=L
25	EXT./O 25	The desired function can be assigned.* (Default: Mic Hanger Output)	+5 V pull up, Active=L

\* The desired function can be assigned using the optional CS-FR5000 CLONING SOFTWARE. Ask your dealer for details.

## Icom Inc.

1-1-32, Kamiminami, Hirano-ku, Osaka 547-0003, Japan  
Phone : +81 (06) 6793 5302  
Fax : +81 (06) 6793 0013  
URL : <http://www.icom.co.jp/world/index.html>

### Icom America Inc.

<Corporate Headquarters>  
2380 116th Avenue N.E., Bellevue, WA 98004, U.S.A.  
Phone : +1 (425) 454-8155 Fax : +1 (425) 454-1509  
URL : <http://www.icomamerica.com>  
E-mail : [sales@icomamerica.com](mailto:sales@icomamerica.com)  
<Customer Service>  
Phone : +1 (425) 454-7619

### Icom Canada

Glenwood Centre #150-6165  
Highway 17 Delta, B.C., V4K 5B8, Canada  
Phone : +1 (604) 952-4266 Fax : +1 (604) 952-0090  
URL : <http://www.icomcanada.com>  
E-mail : [info@icomcanada.com](mailto:info@icomcanada.com)

### Icom (Australia) Pty. Ltd.

Unit 1 / 103 Garden Road, Clayton VIC 3168 Australia  
Phone : +61 (03) 9549-7500 Fax : +61 (03) 9549-7505  
URL : <http://www.icom.net.au>  
E-mail : [sales@icom.net.au](mailto:sales@icom.net.au)

### Icom New Zealand

146A Harris Road, East Tamaki,  
Auckland, New Zealand  
Phone : +64 (09) 274 4062 Fax : +64 (09) 274 4708  
URL : <http://www.icom.co.nz>  
E-mail : [inquiries@icom.co.nz](mailto:inquiries@icom.co.nz)

### Beijing Icom Ltd.

10C07, Long silver Mansion, No.88, Yong Ding  
Road, Haidian District, Beijing, 100039, China  
Phone : +86 (010) 5889 5391/5392/5393  
Fax : +86 (010) 5889 5395  
E-mail : [bjicom@bjicom.com](mailto:bjicom@bjicom.com)  
URL : <http://www.bjicom.com>

### Icom (Europe) GmbH

Communication Equipment  
Himmelgeister Str. 100, D-40225 Düsseldorf, Germany  
Phone : +49 (0211) 346047 Fax : +49 (0211) 333639  
URL : <http://www.icomeurope.com>  
E-mail : [info@icomeurope.com](mailto:info@icomeurope.com)

### Icom Spain S.L

Ctra. Rubi, No. 88 Bajos A 08174, Sant Cugat del Valles, Barcelona, Spain  
Phone : +34 (93) 590 26 70 Fax : +34 (93) 589 04 46  
URL : <http://www.icomspain.com>  
E-mail : [icom@icomspain.com](mailto:icom@icomspain.com)

### Icom (UK) Ltd.

Unit 9, Sea St., Herne Bay, Kent, CT6 8LD, U.K.  
Phone : +44 (01227) 741741 Fax : +44 (01227) 741742  
URL : <http://www.icomuk.co.uk>  
E-mail : [info@icomuk.co.uk](mailto:info@icomuk.co.uk)

### Icom France s.a.s.

Zac de la Plaine  
1 Rue Brindejonc des Moulinais BP 5804  
31505 Toulouse Cedex, France  
Phone : +33 (5) 61 36 03 03 Fax : +33 (5) 61 36 03 00  
URL : <http://www.icom-france.com>  
E-mail : [icom@icom-france.com](mailto:icom@icom-france.com)

### Asia Icom Inc.

6F No.68, Sec. 1 Cheng-Teh Road, Taipei, Taiwan, R.O.C.  
Phone : +886 (02) 2559 1899 Fax : +886 (02) 2559 1874  
URL : <http://www.asia-icom.com>  
E-mail : [sales@asia-icom.com](mailto:sales@asia-icom.com)

### Icom Polska

81-850 Sopot, ul. 3 Maja 54, Poland  
Phone : +48 (58) 550 7135 Fax : +48 (58) 551 0484  
E-mail : [icompolska@icompolska.com.pl](mailto:icompolska@icompolska.com.pl)

**Count on us!**

**Icom Inc.**

1-1-32, Kamiminami, Hirano-ku, Osaka 547-0003, Japan

S-14506XZ-C1  
© 2008 Icom Inc.